



Datasheet

RS PRO Stainless steel toggle latch, 75mm length

Stock number: 1929630

EN



- Stainless steel (304) sprung toggle latch
- Complete with catchplate.

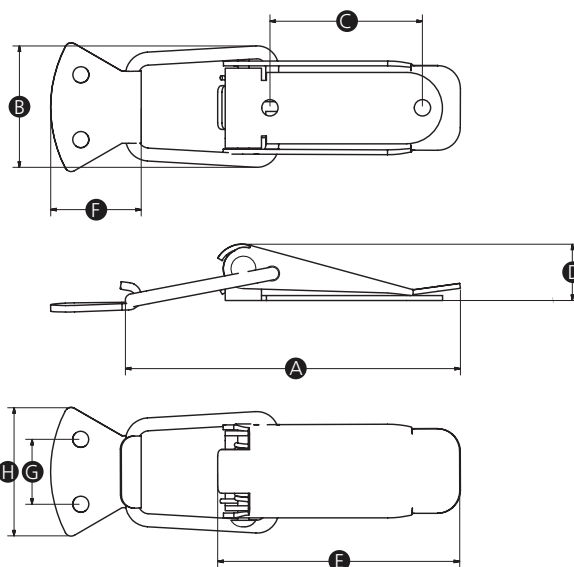

Part No.	A	B	C	D	E	F	G	H	Base hole size	Hook hole size	Max load (N)
1929630	75	34	33	12	56	20	14	30	4	4	500