

Product Datasheet

Screw Clamp Terminal Blocks, 35sq.mm

Screw Clamp Terminal Blocks, 114A, 1000V, 10-2 AWG, 4-35 sq.mm

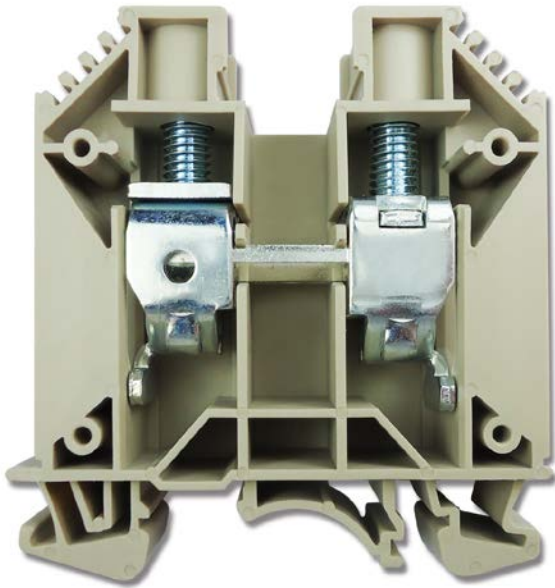



878-7500

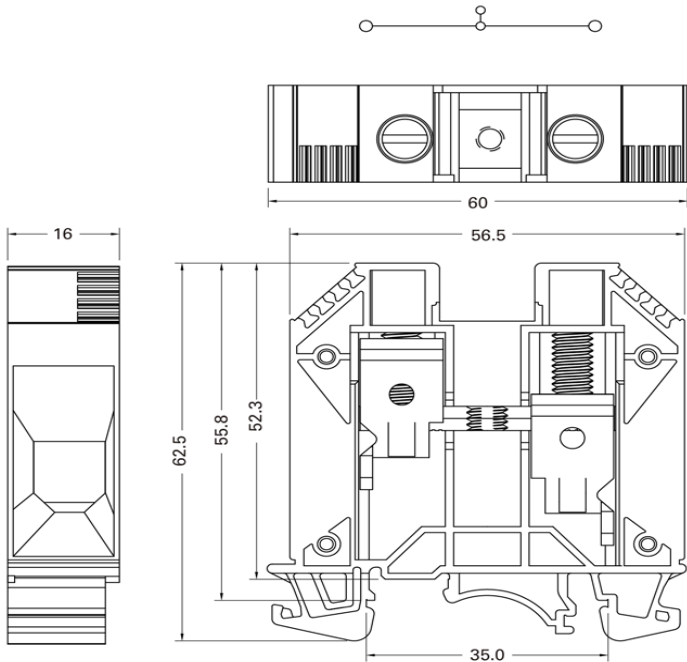

Dimensions in mm

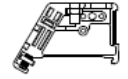

Product Specifications:

Specifications	3.5mm ²
Technical Date	Rated voltage / Rated current / Wire size
UL	1000V / 114A / AWG 10-2
CSA	1000V / 114A / AWG 10-2
IEC	1000V / 125A / 4-35mm ²
Insulating impulse voltage withstand/pollution degree	8KV / 3
Torque (in -lbs)	51
Clamping Screw (M)	M6
Insulation stripping length (mm)	16~18 mm
Net weight per piece	49.6 g
Material / Available Color (Standard Color: Beige)	 Red Orange Beige Blue Grey White Black
Rail Dimensions	T / W / H (mm)
For TS35x7.5 	16 x 60 x 63.5
For TS35x15 	16 x 60 x 71
Accessories	Cat. No.
End Bracket 	8787553
	8787556