



ENGLISH

Datasheet

5P 240 DIN Cable Jack

RS Stock number 491-213



Specifications:

Rating:	100V AC 4A max.
Contact Resistance:	pins-30m Ω max; shell-50m Ω max.
Insulation Resistance:	100M Ω min. at 500V DC
Dielectric Strength:	250V AC R.M.S. for 1 minute

Dimensions(mm)

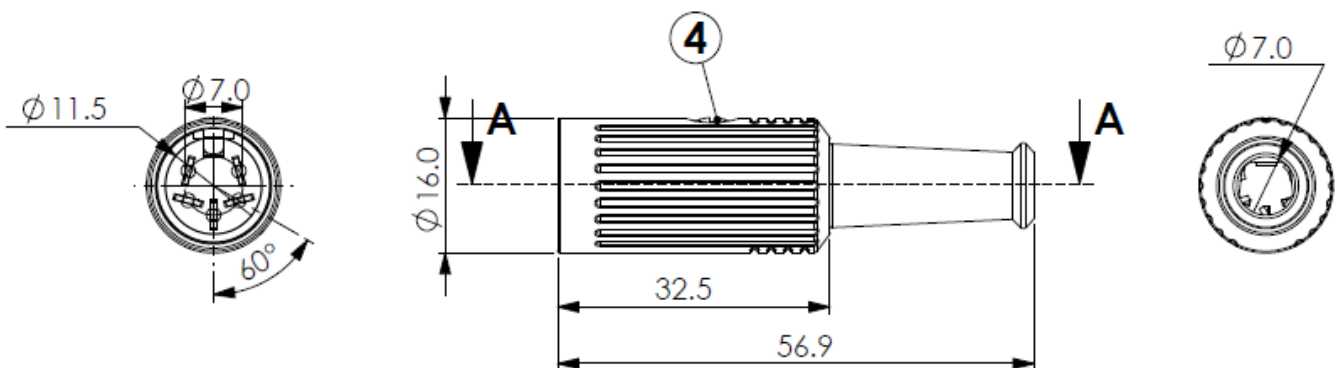

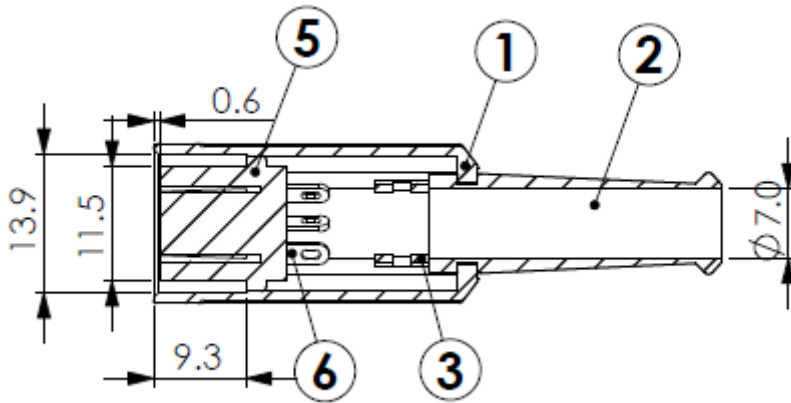

No.	Description	Material	Treat
1	Shield Cover	Zn Alloy	Nickel Ptd.
2	Strain Boot	PVC	
3	'T' Holder	Steel	Nickel Ptd.
4	Setscrew	Steel	Nickel Ptd.
5	Terminals	Brass	Silver Ptd.
6	Housing	ABS	