



Datasheet

Stock No. 190-2872, 190-2873, 190-2874, 190-2875,
190-2876, 190-2877, 190-2878, 190-2879, 190-2880,
190-2881, 190-2882, 190-2883, 190-2885, 190-2886,
190-2887, 190-2888, 190-2889, 190-2891



ENGLISH

RS PRO 70MM STEADY LIGHT MODULE



Led luminous module



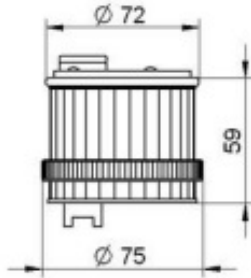













DOME	PC												
RING	PC												
LUMINOUS SOURCE	N°12 LED												
AVAILABLE COLOURS													
VOLTAGE	24 Vdc/Vac – 110Vac – 240Vac												
OPERATION	∞												
CURRENT CONSUMPTION	<table border="1"> <thead> <tr> <th></th> <th>24 Vdc</th> <th>24 Vac</th> <th>110Vac</th> <th>240Vac</th> </tr> </thead> <tbody> <tr> <td>mA</td> <td>65</td> <td>85</td> <td>35</td> <td>35</td> </tr> </tbody> </table>		24 Vdc	24 Vac	110Vac	240Vac	mA	65	85	35	35		
	24 Vdc	24 Vac	110Vac	240Vac									
mA	65	85	35	35									
LIGHT OUTPUT	<table border="1"> <thead> <tr> <th></th> <th>White</th> <th>Yellow</th> <th>Red</th> <th>Blue</th> <th>Green</th> </tr> </thead> <tbody> <tr> <td></td> <td>11</td> <td>5</td> <td>5</td> <td>7</td> <td>3</td> </tr> </tbody> </table>		White	Yellow	Red	Blue	Green		11	5	5	7	3
	White	Yellow	Red	Blue	Green								
	11	5	5	7	3								
LIGHT EFFECT	Fissa Steady Fixe Dauerlicht Luz fija												
IP RATING	IP66												
OPERATING TEMPERATURE	-30°C+50°C												

VIBRATIONS	INDUSTRIAL CEI 60068-2-6 SINE
CERTIFICATIONS, APPROVALS	CE
MOUNTING	Ring
TECHNICAL DRAWING	

Article Number

VOLTAGE

AVAILABLE COLOURS

% \$&, +&	&(J 57 #8 7	
% \$&, +'	&(J 57 #8 7	
% \$&, +(&(J 57 #8 7	
% \$&, +)	&(J 57 #8 7	
% \$&, +*	&(J 57 #8 7	
% \$&, ++	&(J 57 #8 7	
% \$&, +,	%\$J 57	
% \$&, +-	%\$J 57	
% \$&, , \$	%\$J 57	
% \$&, , %	%\$J 57	
1902882	%\$J 57	
1902883	%\$J 57	
1902885	&(\$J 57	
1902886	&(\$J 57	
1902887	&(\$J 57	
1902888	&(\$J 57	
1902889	&(\$J 57	
1902891	&(\$J 57	