



ENGLISH

Datasheet

RS Article:1854778

RS Pro Battery Holder



1. Preface:

The purpose of this product specification is to Dimension and drawing

CR1220

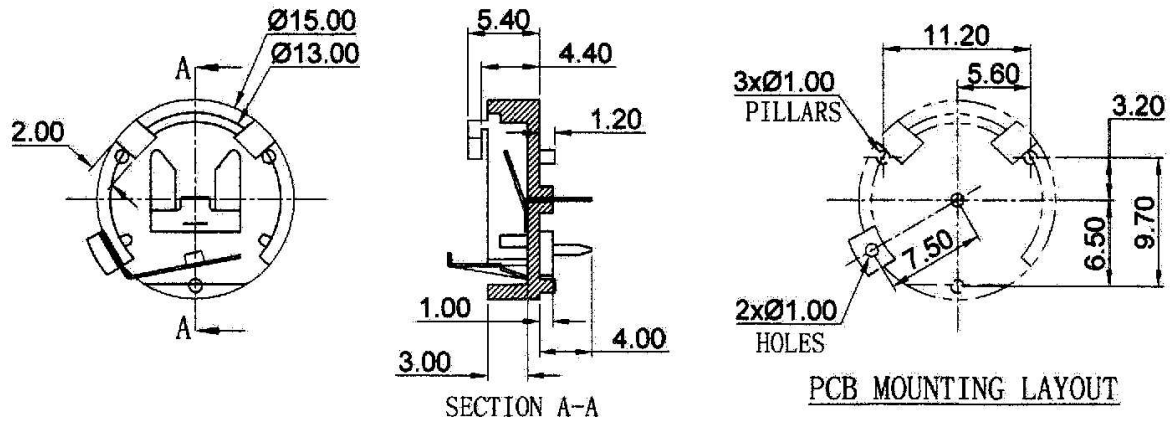

NOTES:

1. MATERIAL:

HOUSING: PBT+30%GF UL94V0 BLACK COLOR

CONTACT: PHOSPHOR BRONZE 0.20MM THK

TIN PLATED OVER NICKEL

2. CURRENT RATING : 2A (AC/DC)

3. VOLTAGE RATING : 500V (AC/DC)

4. CONTACT RESISTANCE: 30 MILLIOHMS

5. INSULATION RESISTANCE: 500 MEGAOHMS

6. TEMPERATURE RANGE: -55°C TO $+85^{\circ}\text{C}$

7. HUMIDITY: 40°C AND 90-95% RH FOR 96 HOURS

8. RoHS COMPLIANT

Measure: mm