

Datasheet

RS Article: 177 - 0130

DC – D Frame Solenoid 24V

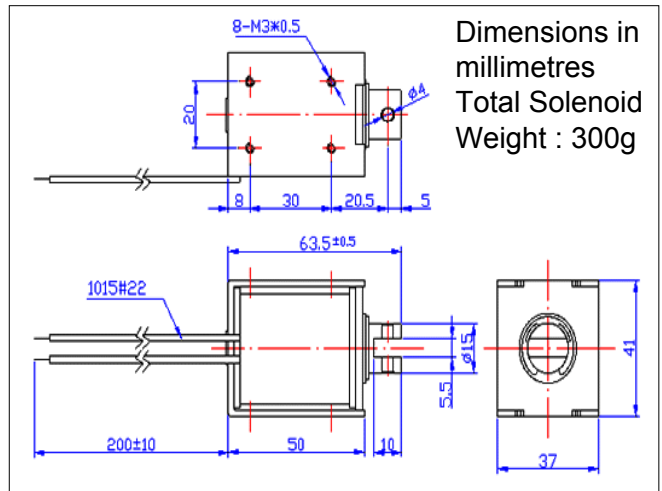

Specifications:

Features:

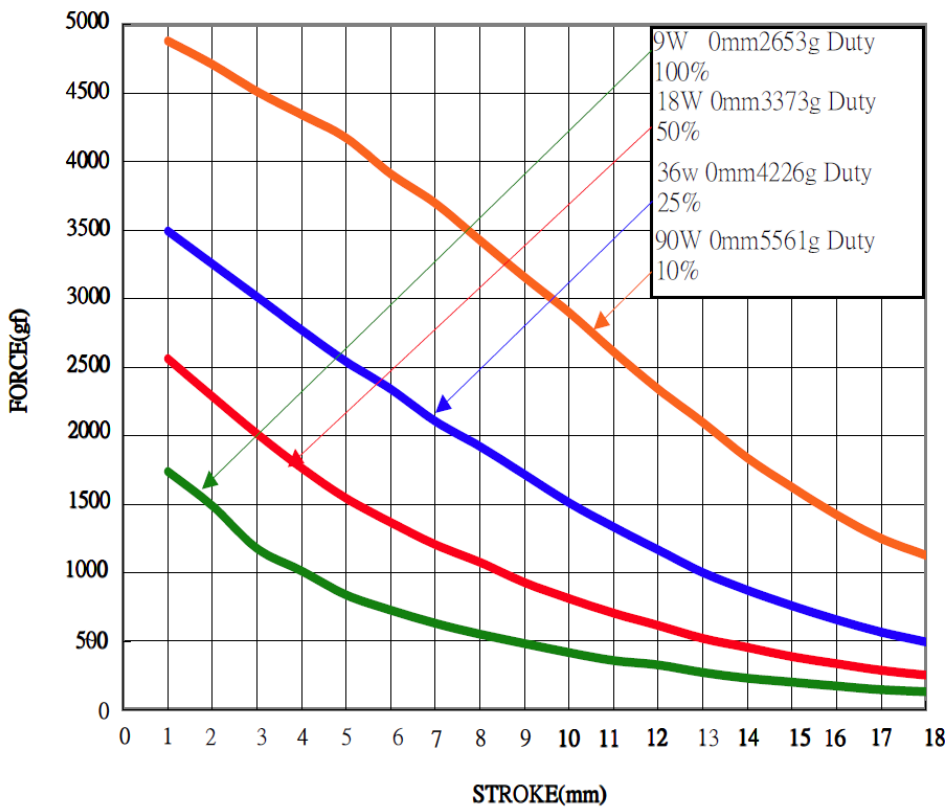

- Pull type
- Flying leads
- Corrosion resistant plated parts