

Product Datasheet

# Screw Clamp Terminal Blocks, 2.5sq.mm

Screw Clamp Terminal Blocks, 24A, 600V, 22-10 AWG, 0.5-2.5 sq.mm, Blue

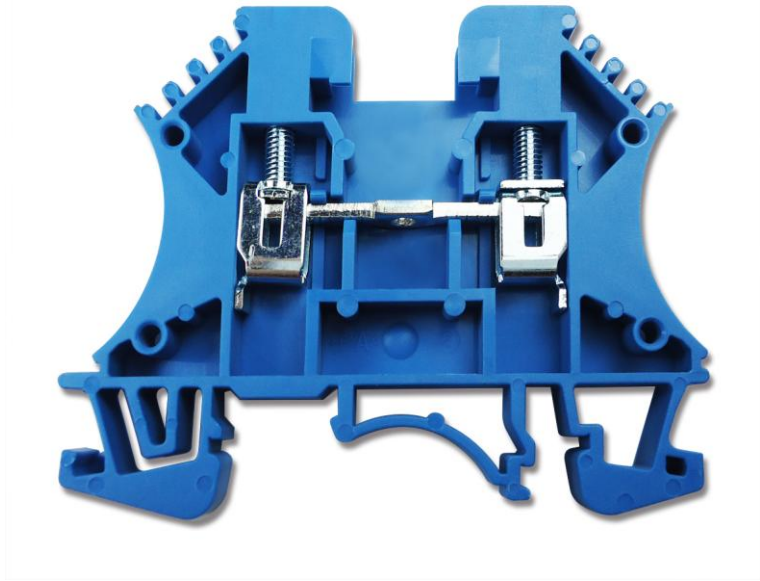



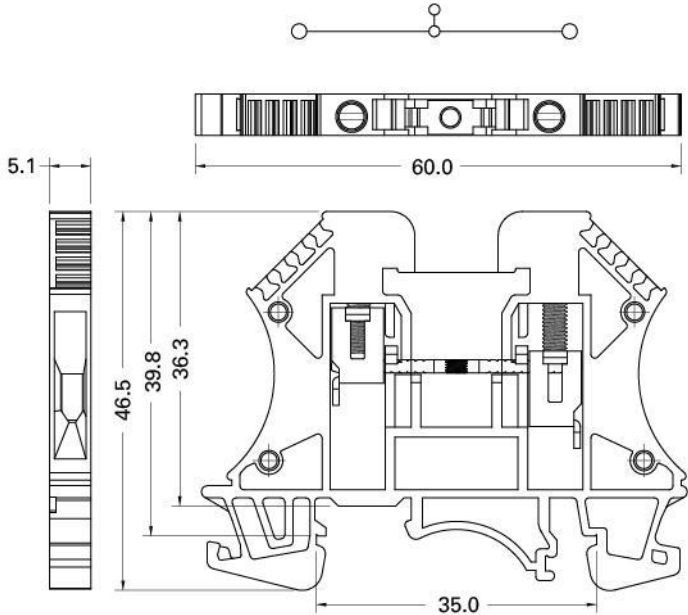

878-7499



## Dimensions in mm

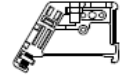
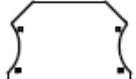
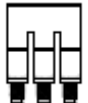

**Product Specifications:**

Specifications	2.5mm <sup>2</sup>
<b>Technical Date</b>	<b>Rated voltage / Rated current / Wire size</b>
UL	600V / 24A / AWG 22-10
CSA	600V / 24A / AWG 22-10
IEC	800V / 24A / 0.5-2.5mm <sup>2</sup>
Insulating impulse voltage withstand/pollution degree	8KV / 3
Torque (in -lbs)	7
Clamping Screw (M)	M3
Insulation stripping length (mm)	10~12 mm
Net weight per piece	7.8g
Material / Available Color (Standard Color: Beige)	 Red    Orange    Beige    Blue    Grey    White    Black
<b>Rail Dimensions</b>	<b>T / W / H (mm)</b>
For TS35x7.5 	5.1 x 60 x 47.5
For TS35x15 	5.1 x 60 x 55
<b>Accessories</b>	<b>Cat. No.</b>
End Bracket 	8787553
	8787556
End plate 	8787540
Cross 	8787572
Marking Tags 	8787590