







Datasheet

# RS PRO ST12 Front Panel Mount Connector



## Technical Specifications:

Number of contact	2	3	4	5	6	7	9
Male contact face view							
Rated current (A)	13A	13A	5A	5A	5A	5A	3A
Contact diameter	∅ 1.6×2	∅ 1.6×3	∅ 1×4	∅ 1×5	∅ 1×6	∅ 1×7	∅ 0.7×9
Rated voltage(AC.V)	250V	250V	200V	180V	125V	125V	125V
Test voltage(AC.V)1 min	1500V	1500V	1500V	1000V	1000V	1000V	1000V
Contact resistance mΩ	2	2	5	5	5	5	10
Wire size mm <sup>2</sup> /AWG	≤2/14	≤2/14	≤0.785/18	≤0.785/18	≤0.785/18	≤0.785/18	≤0.785/18

## Product Details

The RS Pro ST12 series is a range of small but robust waterproof connectors, which are sealed to IP67. Threaded coupling ensures a secure connection, and black nickel-plated zinc alloy bodies provide an attractive finish. Versions are available for in-line cable to cable and for cable to panel connections. Plugs and receptacles are available with either male pins or female sockets. These products are suited for use in indoor or outdoor applications where space is a consideration. Typical applications include communications, medical and test & measurement equipment.

## Features and Benefits

- Threaded Coupling
- IP67
- Black Nickel-plated
- 2-9 Poles
- Cable to Cable and Cable to Panel Connections



## Dimensional line drawings

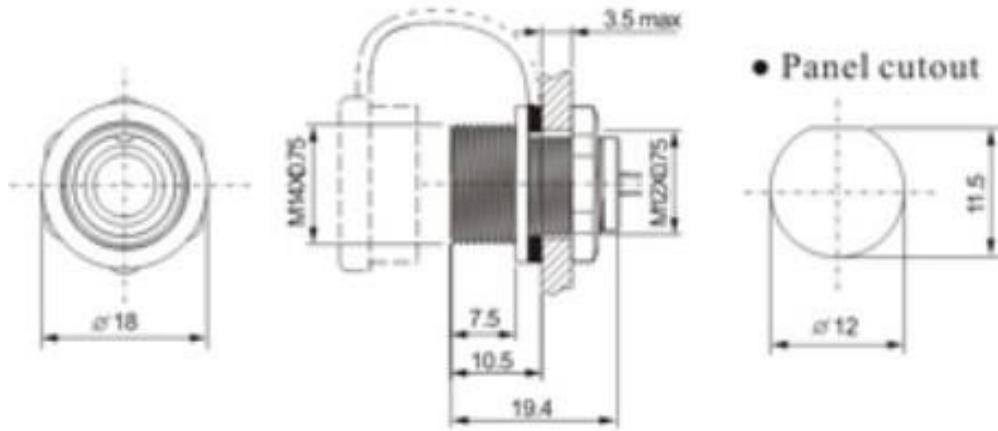

## Quality Standards

