

## Datasheet

### SPDT Toggle Switch On-Off-On, 5A, Panel Mount

RS Stock number [734-7135](#)



#### SPECIFICATIONS

**CONTACT RATING:** Dependent upon contact material

**MECHANICAL LIFE:** 40,000 make-and-break cycles.

**CONTACT RESISTANCE:** 10m $\Omega$  max. initial @ 2-4VDC

100mA for both silver and gold plated contacts.

**INSULATION RESISTANCE:** 1,000 M $\Omega$  min.

**DIELECTRIC STRENGTH:** 1,000 Vrms min. @ sea level.

**OPERATING TEMPERATURE:** -30°C to 85°C.

#### MATERIALS

**CASE:** Diallyl phthalate (DAP) (UL94v-0).







**ACTUATOR:** Brass, chrome plated.

**BUSHING:** Brass, nickel plated.

**HOUSING:** Stainless steel.

**SWITCH SUPPORT:** Brass, tin plated.

**CONTACT / TERMINALS:** Brass, Silver or gold plated.

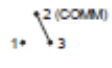
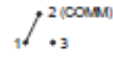
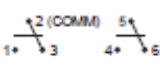
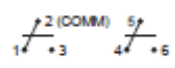
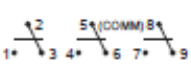
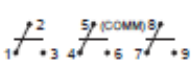
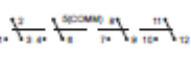
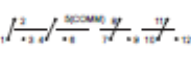
NO. POLES	UL/CSA MODEL NO.	MODEL NO.	SWITCH FUNCTION			CONNECTED TERMINALS / SCHEMATIC		
			POS.1	POS.2	POS.3	POS.1	POS.2	POS.3
								
SP	Q1111	1MS1	ON	NONE	ON		N/A	
	Q1112	1MS2	ON	NONE	MOM			
	Q1113	1MS3	ON	OFF	ON			
	Q1114	1MS4	MOM	OFF	MOM			
	Q1115	1MS5	ON	OFF	MOM			
DP ▲ ▲	Q1121	1MD1	ON	NONE	ON		N/A	
	Q1122	1MD2	ON	NONE	MOM			
	Q1123	1MD3	ON	OFF	ON			
	Q1124	1MD4	MOM	OFF	MOM			
	Q1125	1MD5	ON	OFF	MOM			
	Q1126	1MD6	ON	ON	ON			
	Q1127	1MD7	MOM	ON	MOM			
	Q1128	1MD8	ON	ON	MOM			
3P	Q1131	1M31	ON	NONE	ON		N/A	
	Q1132	1M32	ON	NONE	MOM			
	Q1133	1M33	ON	OFF	ON			
	Q1134	1M34	MOM	OFF	MOM			
	Q1135	1M35	ON	OFF	MOM			
4P ▲ ▲	Q1141	1M41	ON	NONE	ON		N/A	
	Q1142	1M42	ON	NONE	MOM			
	Q1143	1M43	ON	OFF	ON			
	Q1144	1M44	MOM	OFF	MOM			
	Q1145	1M45	ON	OFF	MOM			
	Q1146	1M46	ON	ON	ON			
	Q1147	1M47	MOM	ON	MOM			
	Q1148	1M48	ON	ON	MOM			

**POLE OPTIONS**

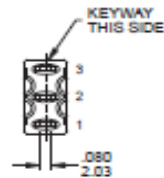
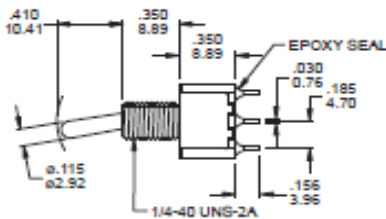
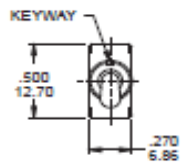

SPDT

Part No. Shown : 1MS1T1B1M1QE

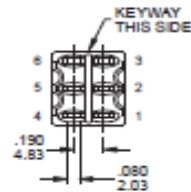
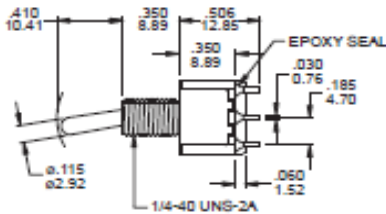
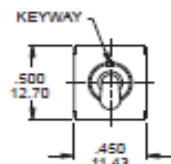

DPDT

Part No. Shown : 1MD1T1B1M1QE

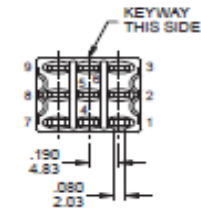
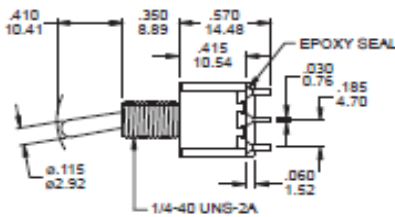
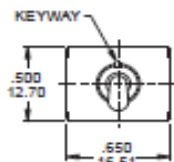

3PDT

Part No. Shown : 1M31T1B1M1QE

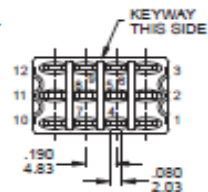
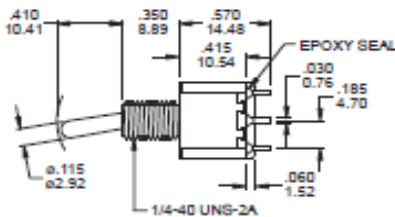
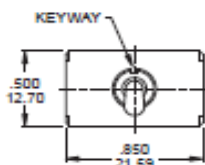

4PDT

Part No. Shown : 1M41T1B1M1QE

**3-WAY SWITCH**

**3-Way Wiring Diagram Schematics**

**SINGLE POLE, 3 POSITION**

Model No.	POS 1	POS 2	POS 3
1MD6	ON	ON	ON
Term. Comm.	2-3,5-6	2-3,5-4	2-1,5-4

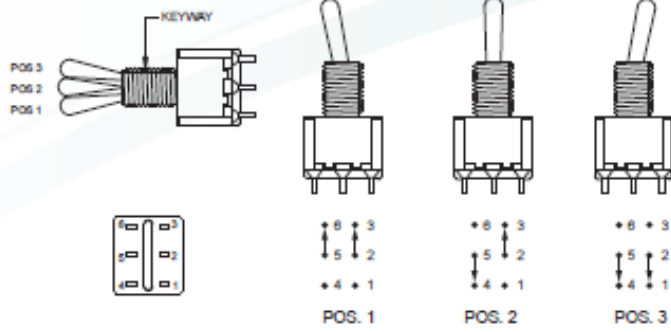

**DOUBLE POLE, 3 POSITION**

Model No.	POS 1	POS 2	POS 3
1M46	ON	ON	ON
Term. Comm.	2-3,5-6 8-9,11-12	2-3,5-4 8-9,11-10	2-1,5-4 8-7,11-10

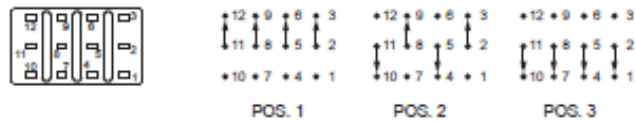

**ACTUATOR OPTIONS**

**T1 STD**

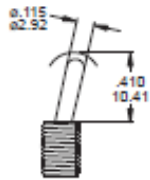

**T2**

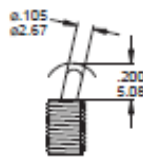

**T3**

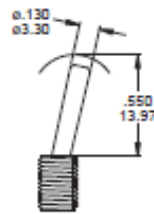

**T4**

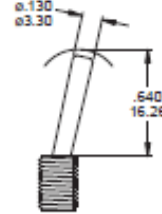

**T5**

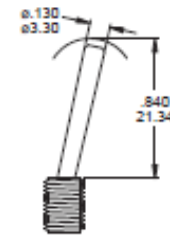

**NOTE** T1 ~ T5 Actuator shown with standard B1 Bushing ;  
 Add .070 (1.78) for B3 Bushing ;  
 Subtract .020 (0.51) for B6 Bushing ;  
 Std for M1 , M2 Terminal sub .016 (0.40) for M6 , M7 , VSX

**T6 FLATTED WITH ANTIROTATION**

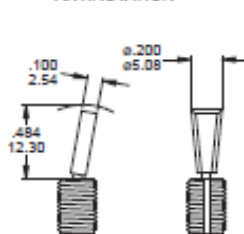

**T61**

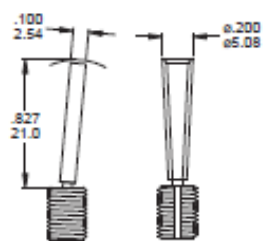

**T62**

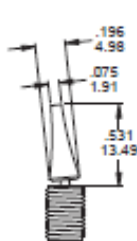

**T63**

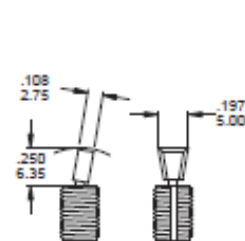

**NOTE** T6, T6-1, T6-2 , T63 use with B11, B12, B15, B16 bushing only.

T7

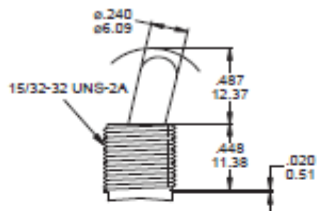

Use with B13 bushing  
Use with B18,B20 the lever is antirotation  
and the size of lever is 13.00mm

T8

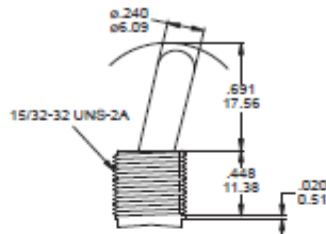

Use with B13 bushing  
Use with B18,B20 the lever is antirotation  
and the size of lever is 18.00mm

T9

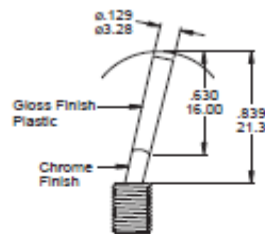

B1 / B2 bushing std  
with black and red color only ( std. )

TA PLASTIC BLACK

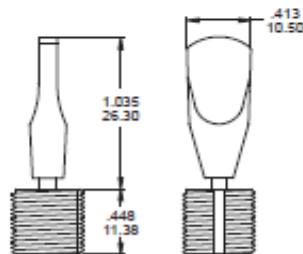

Use with B18 bushing only

T11

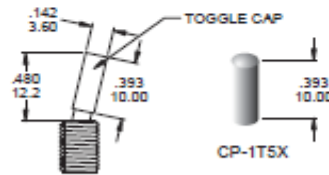

NOTE T11Actuator shown with standard B1 Bushing ;  
Add .070 ( 1.78 ) for B3 Bushing ;  
Subtract .020 ( 0.51 ) for B6 Bushing.  
Std for M1,M2 Terminal sub .016 (0.40 ) for M6,M7.VSX

Plastic No.Color :

ITEM NO	COLOR
1	White
2	Black (Std)
3	Red
4	Orange
5	Yellow
6	Green
7	Blue
8	Brown
9	Gray

T82 , TA , T9 , T11  
ACTUATOR ONLY

TL1B25

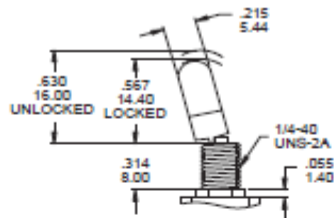

TL2B25

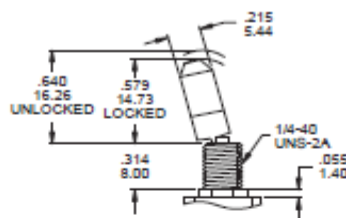

TL3B25

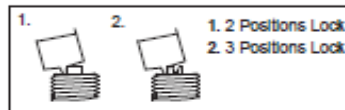
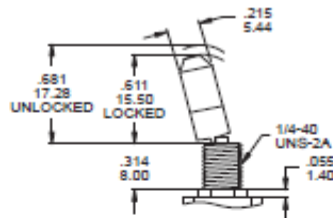

BUSHING OPTIONS

B1 THD STD  
B2 NON-THD

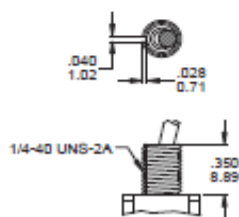

B3 THD  
B4 NON-THD

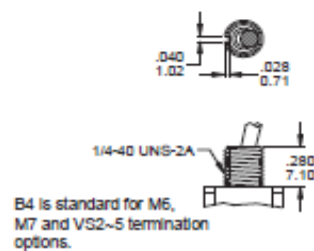

B5 HIGH TORQUE

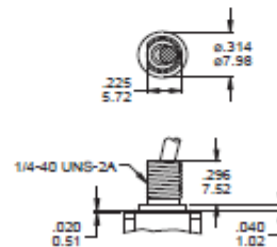

**B6 HIGH TORQUE**

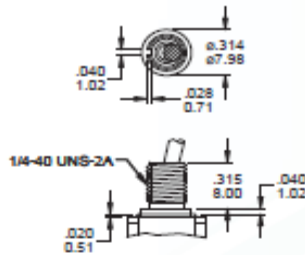

**B7 THD STD**

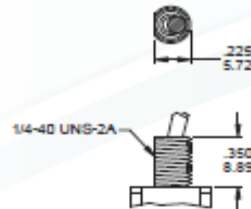

**B8 METRIC THD**

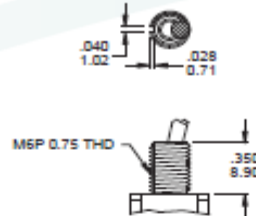

**B9 SPLASH PROOF**

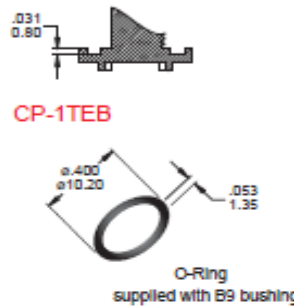
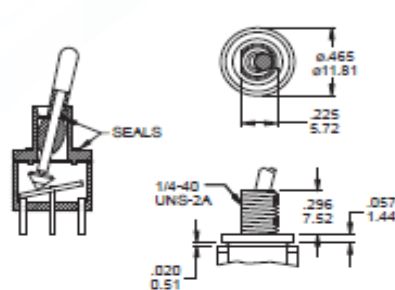

**B11 THD STD  
B12 NON-THD**

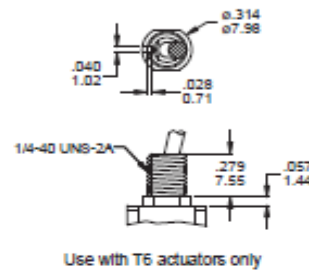

**B15 THD STD  
B16 NON-THD**

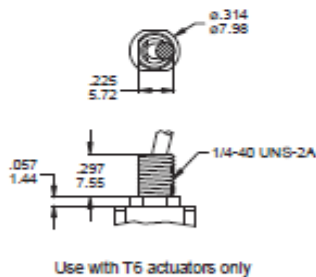

**B17**

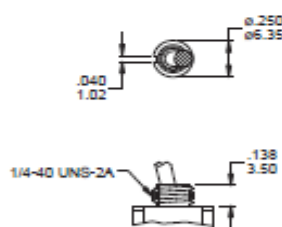

**B13**

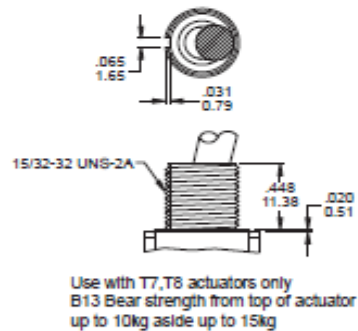

**B14 SPLASH PROOF**

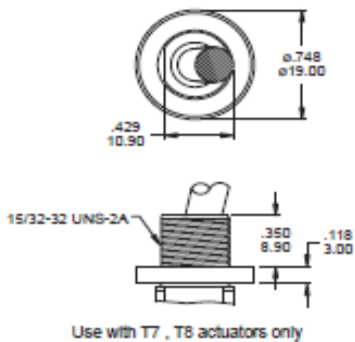

**B18**

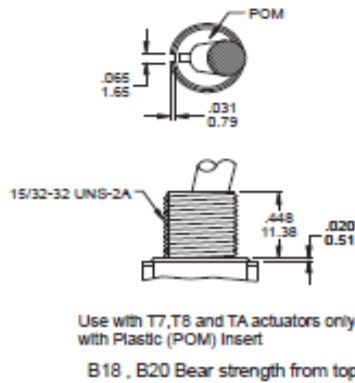

**B20**

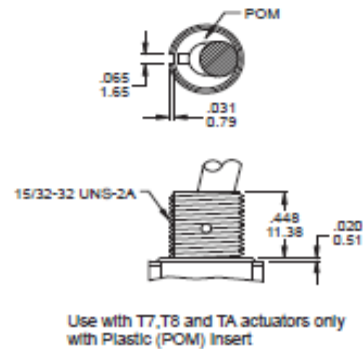

**PANEL MOUNTING**

**1/4 IN BUSHING**

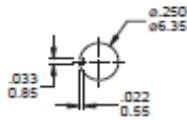

Without locking ring (Keyway)

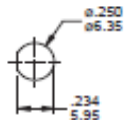

Without locking ring (Flat)

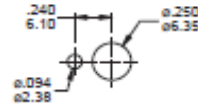

With standard locking ring.

**METRIC BUSHING**

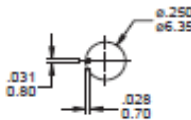

Without locking ring (Keyway)

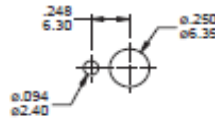

With standard locking ring.

**15/32 IN BUSHING**

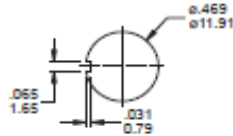

Without locking ring (Keyway)

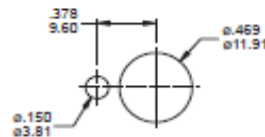

With standard locking ring.

**SPLASH PROOF BUSHING**

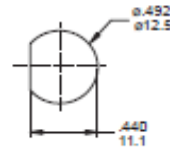

Without locking ring (Flat)

**TERMINATION OPTIONS**

**M1 Solder lug**

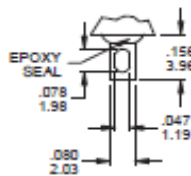

.030(0.76) THK.

**M2 PC Thru-hole**

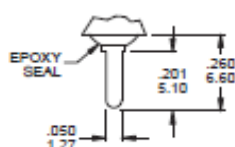

.030(0.76) THK.

**M3 Quick connect**

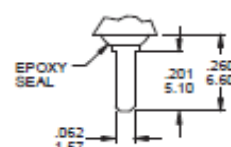

.030(0.76) THK.

**M5 Wire Wrap**

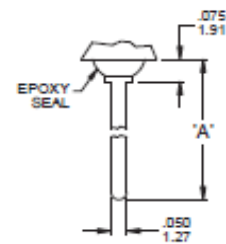

.030(0.76) THK.

**OTHER TERMINATION OPTIONS**

- M6 RIGHT ANGLE P.C. MOUNT
- M7 RIGHT ANGLE P.C. MOUNT
- VS2 VERTICAL BRACKET P.C. MOUNT
- VS3 VERTICAL BRACKET P.C. MOUNT
- VS5 VERTICAL BRACKET P.C. MOUNT

OPTION CODE	DIM. 'A'
M5-1	.736 (18.70)
M5-2	.953 (24.20)
M5-3	.415 (10.55)
M5-4	1.062 (26.97)



M6

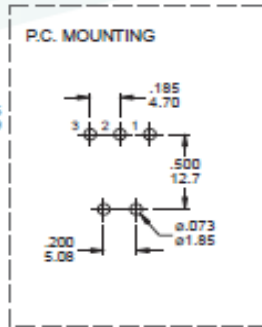
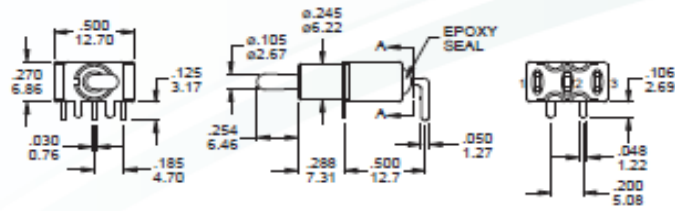

SPDT

Part No. Shown : 1MS1T2B4M6QE

SECTION A-A  
TERM. NOS. FOR  
REFERENCE ONLY

M6

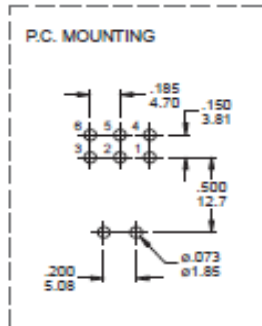
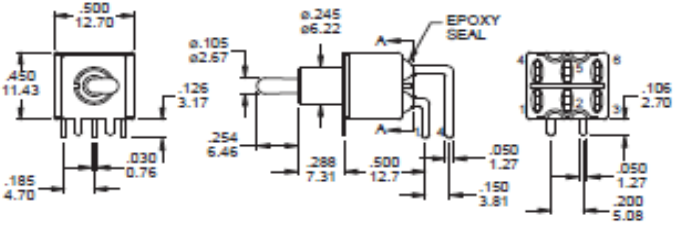

DPDT

Part No. Shown : 1MD1T2B4M6RE

SECTION A-A  
TERM. NOS. FOR  
REFERENCE ONLY

M7

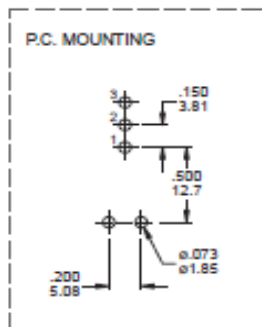
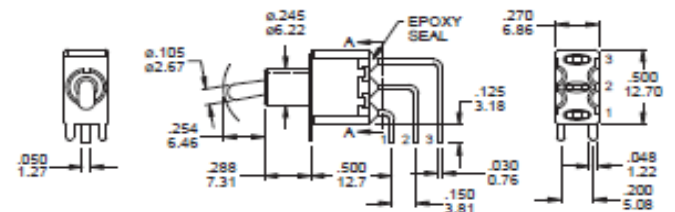

SPDT

Part No. Shown : 1MS1T2B4M7QE

SECTION A-A  
TERM. NOS. FOR  
REFERENCE ONLY

M7

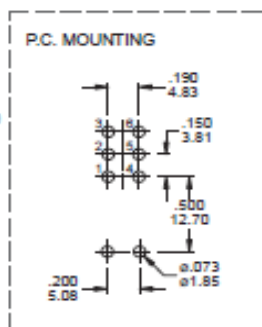
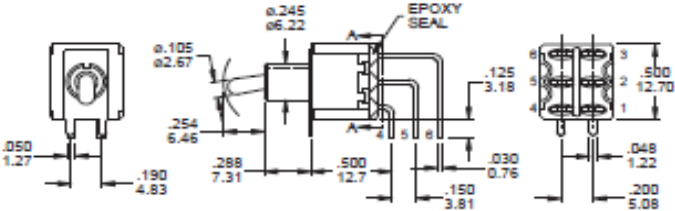

DPDT

Part No. Shown : 1MD1T2B4M7QE

SECTION A-A  
TERM. NOS. FOR  
REFERENCE ONLY



M7

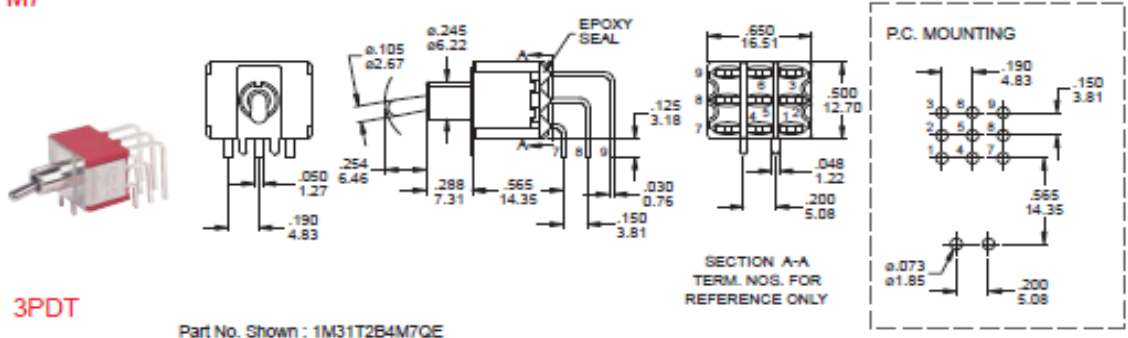

3PDT

Part No. Shown : 1M31T2B4M7QE

M7

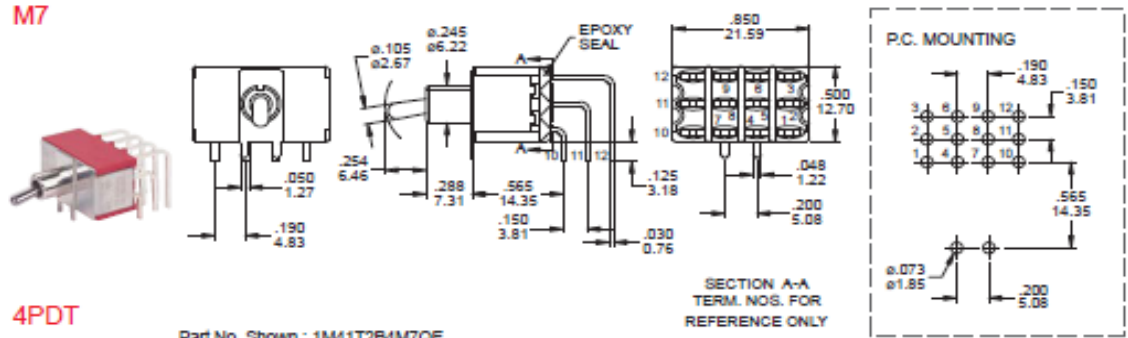

VS5

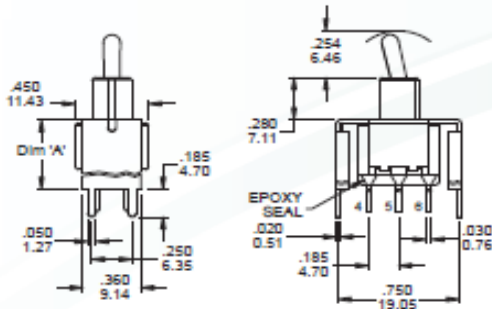

OPTION CODE	DIM. "A"
VS4	.450 11.68
VS5	.630 16.00

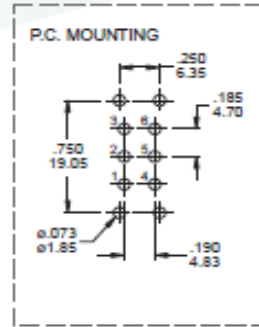

DPDT

Part No. Shown : 1MD1T2B4VS5QE

**SNAP-IN TERMINATION OPTIONS**

M6N



V2N



**HARDWARE**

1/4 NUTS HDW2

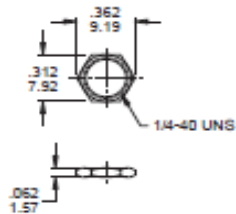

Supplied standard with B1, B3, B5, B6 and B9 options

DRESS NUT HDW3

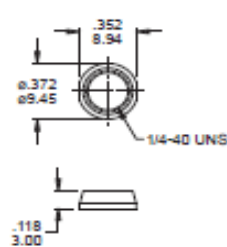

METRIC NUT HDW6

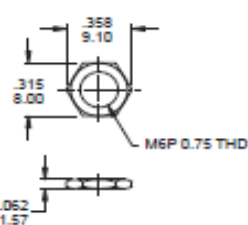

Supplied standard with B8 metric bushing

LOCK WASHER HDW11

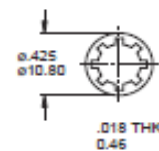

Supplied standard with B1 / B3 bushing

OPTIONAL RUBBER HOOD SEALING

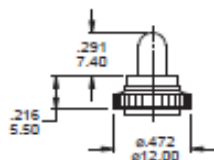

K1=Metric  
E1=Inch (Std.)  
for actuator T1, T2 and  
B1, B3, B5, B6 Bushing only

15/32 NUTS HDW4

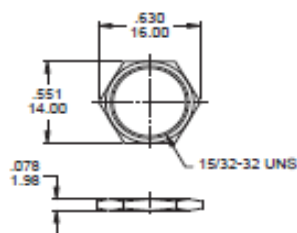

Supplied standard with B13 bushing

LOCK WASHER HDW12

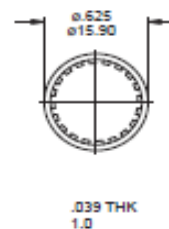

Supplied standard with B13 bushing

**HDW15**

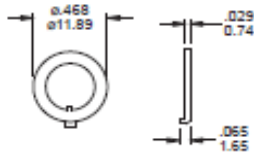

Locking ring supplied standard

**HDW16**

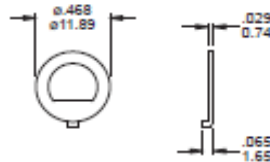

Locking ring supplied with B5 bushing

**HDW17**

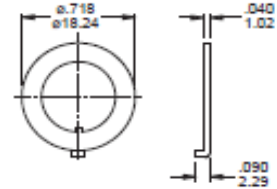

Locking ring supplied with B13,B16,B20 bushing

**HDW18**

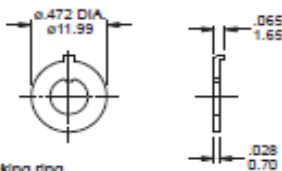

Locking ring supplied with B8 bushing

**HDW19**

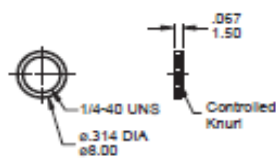

NU-1M18

**HDW20**

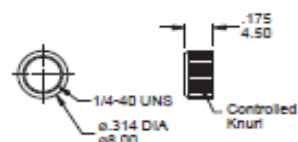

NU-1M24

**OPTIONAL TOGGLE CAP**

**CP-T1XX**



Use with T1

**CAP Color :**

ITEM NO	COLOR
1	White
2	Black (Std)
3	Red
5	Yellow
6	Green
7	Blue
9	Gray

**CONTACT MATERIAL OPTIONS**

	CONTACT PLATING	TERMINAL PLATING	RATINGS
<b>Q</b>	Silver	<b>Q</b> = Silver	5 Amps with resistant load @ 120VAC or 28VDC 2 Amps with resistant load @ 250VAC
<b>S</b>		<b>S</b> = Silver,pure - tin	
<b>C</b>	Gold over Silver	<b>C</b> = Gold over silver	
<b>K</b>		<b>K</b> = Gold over silver,pure - tin	
<b>R</b>	Gold	<b>R</b> = Gold	0.4 Volt - Amps ( VA ) max. @ 20V max. ( AC or DC )
<b>G</b>		<b>G</b> = Gold,pure - tin	

**SOLDERING PROCESSES**

**MANUAL SOLDERING:** Use soldering iron of 30 watts, controlled at 350°C approximately 5 seconds while applying solder.

**WAVE SOLDERING:** Recommended Soldering Temperature: 260 ± 5°C  
Duration of Solder Immersion: Max 5 sec. (PCB is 1.6mm in thickness)