



Datasheet

RS PRO Heat Sink Enclosure Model EAB

Stock number: 188-1268

EN



Designed for both professional users and home hobbyists alike, EAB features extruded aluminum heatsink side panel.

Features

- Extruded heavy duty aluminum (AL6063) side frames provide high efficiency cooling and strength.
- Multiple sizes for any application.
- Suitable for wide range of Electronics & Instrument applications.
- Simple and easy to assembly.
- Black powder coat standard color.

Standards and Materials

- Conforms to IEC-60297-3.
- Premium grade aluminum sheet: AL 5052 and extrusion: AA 6063 (Aluminum Alloy).
- Designed and manufactured under ISO 9001:2015 and ISO 14001:2015.
- All materials RoHS compliant.

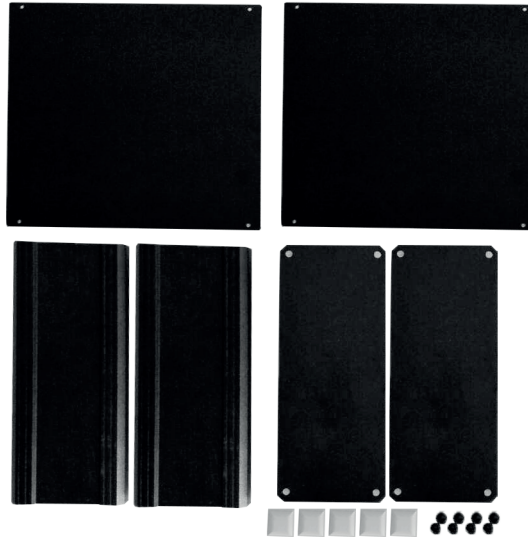

Models and Dimensions

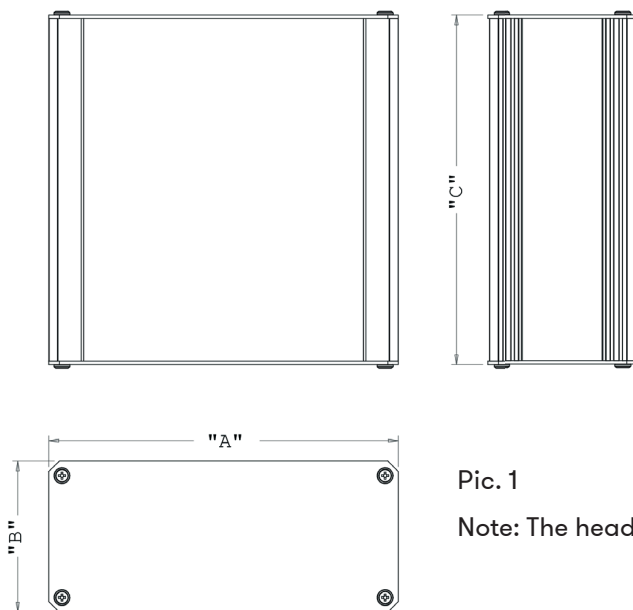

Pic. 1

Note: The head of screw M5x10 Phillips is 2.00 mm thick.

Pic. 1 Table

For side frame 1U and 2U

No.	Model	Dimension unit mm.			Net Weight (kg)	Shipping Weight (kg)
		"A"	"B"	"C"		
1	EAB 1.0-100W-200D	100	41	200	0.45	0.49
2	EAB 1.0-100W-300D	100	41	300	0.62	0.67
3	EAB 1.0-100W-400D	100	41	400	0.78	0.86
4	EAB 1.0-200W-200D	200	41	200	0.63	0.78
5	EAB 1.0-200W-300D	200	41	300	0.92	1.04
6	EAB 1.0-200W-400D	200	41	400	1.18	1.32
7	EAB 1.0-300W-200D	300	41	200	0.88	1.00
8	EAB 1.0-300W-300D	300	41	300	1.23	1.38
9	EAB 1.0-300W-400D	300	41	400	1.57	1.73
10	EAB 2.0-100W-200D	100	86	200	0.58	0.62
11	EAB 2.0-100W-300D	100	86	300	0.79	0.85
12	EAB 2.0-100W-400D	100	86	400	1.00	1.08
13	EAB 2.0-200W-200D	200	86	200	0.85	0.93
14	EAB 2.0-200W-300D	200	86	300	1.15	1.40
15	EAB 2.0-200W-400D	200	86	400	1.45	1.59
16	EAB 2.0-300W-200D	300	86	200	1.12	1.24
17	EAB 2.0-300W-300D	300	86	300	1.50	1.72
18	EAB 2.0-300W-400D	300	86	400	1.89	2.05

Description:

1. Side Frame
2. Top/Bottom Cover
3. Front/Rear Panel
4. Umbrella Phillips Screw M5-10 (Dog Point)
5. Rubber Feet

Quantity

- [2]
[2]
[2]
[8]
[4]

General Purpose Bar Kit [GP Bar] option

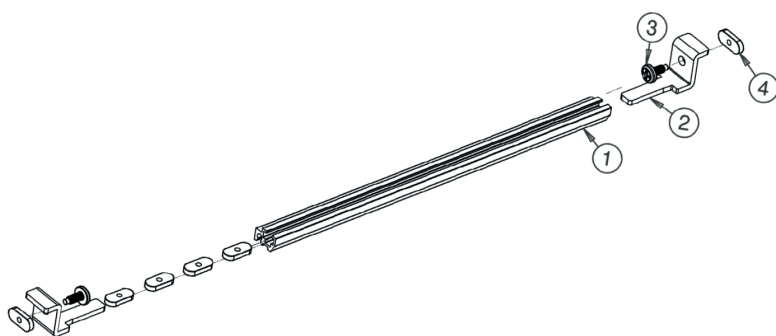

GP Bar Profile



GP Bar Large side: GP Bar L
for EAB3.0, EAB4.0, EAB5.0 and
EAB6.0



GP Bar Small side: GP Bar S
for EAB1.0 and EAB2.0

GP Bar Kit (L or S) consist of

Quantity

- | | |
|---|------|
| 1. GP Bar (L or S) | [2] |
| 2. GP Bracket | [4] |
| 3. Umbrella Phillips Screw M3-6 (Dog Point) | [4] |
| 4. Nut OB M3 | [12] |

Note: GP Bar length relates to width ["A" dimension] when you order please tell us GP Bar profile and the width such as "GP-S Bar 100W or GP-L Bar 200W".

User should prepare all component assemblies and complete any modifications (drilling/punching holes) before assembly.

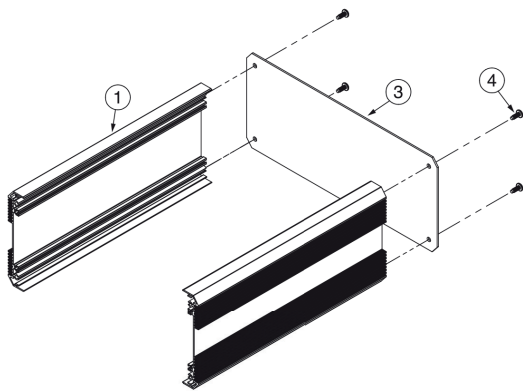

1. Install ③ front/rear panel to ① side frame and secure with ④ Umbrella Phillips Screw M5-10 (Dog Point).

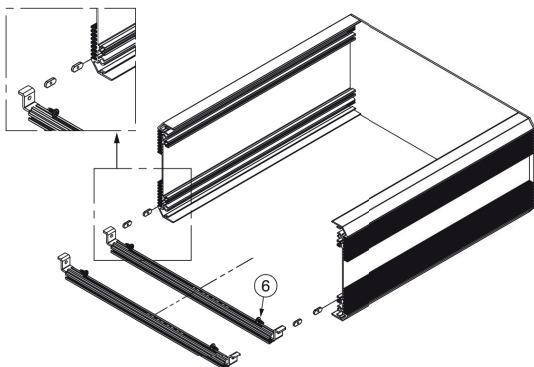

2. Install ⑥ GP Bar Kit [option] into the slide rail slot in side frame and secure with GP Bar position by Umbrella Phillips Screw M5-10 (Dog Point). We advise to install user components at this stage. Our GP Bar Kits are ideal for this purpose, but user can prepare their own method.

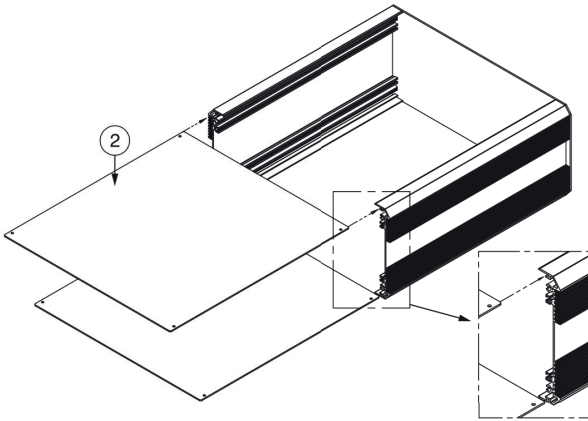

3. Slide the ② top/bottom covers into the side frame slots.

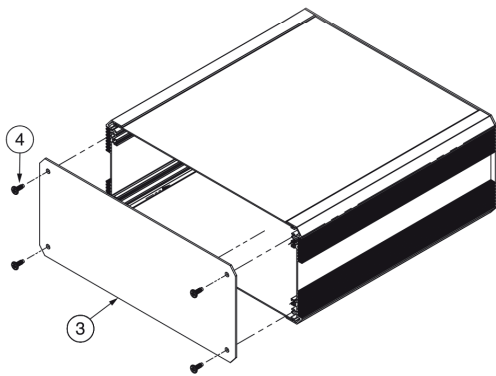

4. Install ③ front/rear cover and secure with Umbrella Phillips Screw M5-10 (Dog Point).

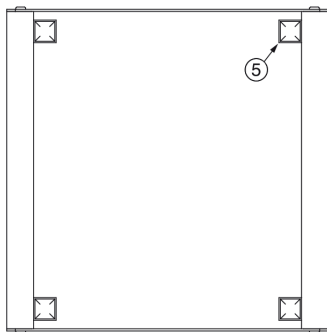

5. Place the ⑤ rubber feet 4 pcs. At the bottom side of EAB box.
*clean surface before placing rubber foot.
Isopropyl Alcohol 70% is recommended

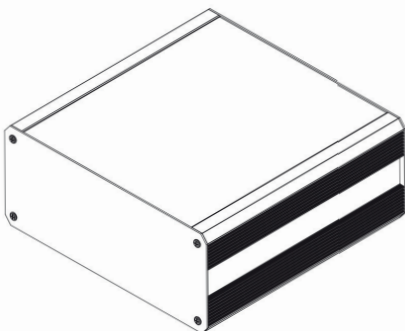

6. Completed Assembly

Specifications

Attribute	Value
Product 188-1268	EAB 2.0-300W-300D
External Width	300mm
External Depth	300mm
External Height	86mm
External Dimensions	300 x 400 x 86
Body Material	Aluminum Extrusion
IP Rating	IP40
Color	Black
Lid Color	Black
Flanged	No
Shielded	No
Gasket Material	No
Standard Met	ROHs Compliant
Application	Electrical, Electronic, Industrial