



Datasheet

RS PRO 1m D25 to D25 M-F Serial Cable

Stock number: 2369139

EN

The RS PRO 1m D25 Male to D25 Female Serial cable has all 25 pins connected in a straight-through configuration using beige cable.

The connector hoods are made from beige PVC and have a strain relief on the end of the hood to support the cable and to stop the cable from splitting around the hood.

- DB25
- Thumbscrews
- All pins connected
- 30 AWG
- Shield and Drain
- Gold flashed contacts

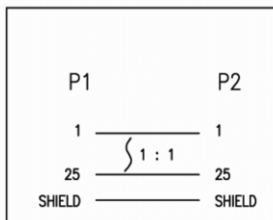
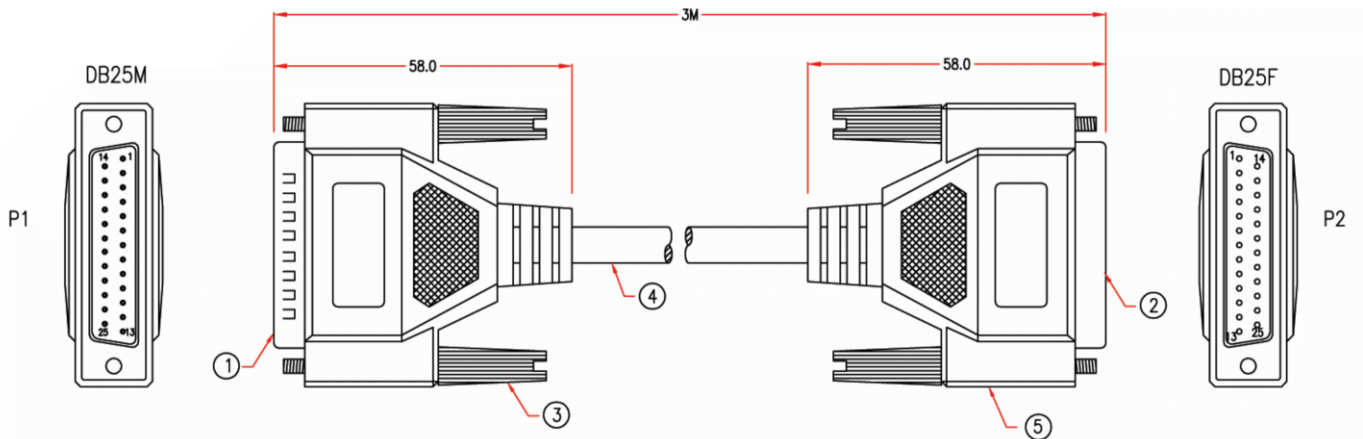

5	MOLDED PVC GREY	
4	25C 28AWG, ALUM-MYLAR FOIL SHIELDING WITH DRAIN WIRE, OD 7.0, JACKET GREY	
3	MOLDED THUMBSCREW #4-40, GREY	4
2	DB25 FEMALE, GOLD FLASH ON CONTACTS, BLUE INSULATOR	1
1	DB25 MALE, GOLD FLASH ON CONTACTS, BLUE INSULATOR	1
No.	DESCRIPTION	Q'TY