

Datasheet

Two spoke handwheel

RS Stock No: 1611971

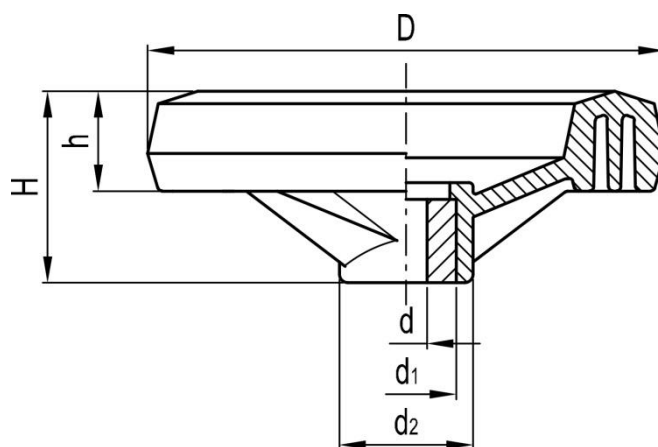

Specification

Handwheel material: Glass-fibre reinforced technopolymer

Zinc-plated steel hub, standard holes



ENGLISH

Stock no	D	d	H	h	d1	d2
1611970	80	8	35	18	18	24
1611971	80	10	35	18	18	24
1611972	100	10	37	20	18	24
1611973	100	12	37	20	18	24
1611974	126	10	46	24	24	32
1611975	126	12	46	24	24	32
1611976	126	14	46	24	24	32
1611977	126	15	46	24	24	32
1611978	160	10	52	26.5	26	40
1611979	160	12	52	26.5	26	40
1611980	160	14	52	26.5	26	40
1611981	160	16	52	26.5	26	40
1611983	200	10	62	28	30	50
1611984	200	16	62	28	30	50
1611985	200	20	62	28	30	50