

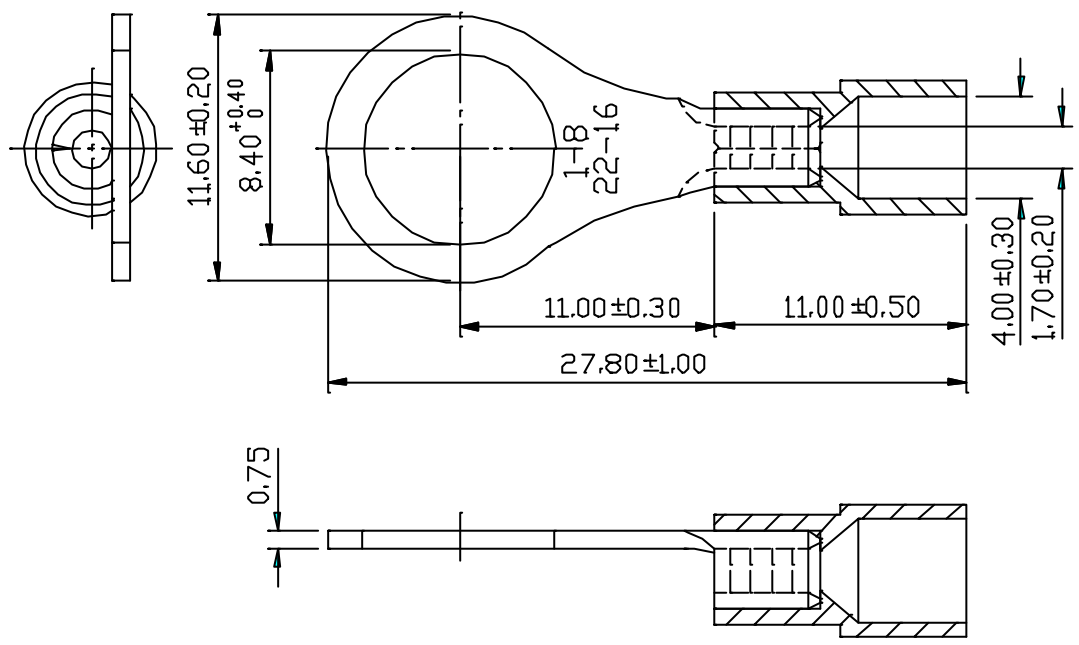

REV	DESCRIPTION	DATE
-----	-------------	------



NOTE:

- MAXIMUM ELECTRIC CURRENT:

A.W.G.	22	20	18	16
AMP.	9	12	17	18
- MAXIMUM ELECTRICAL RATING:
75°C 600 VOLTS MAX.
- INSULATION MATERIAL: VINYL
- INSULATION COLOR: RED
- TERMINAL MATERIAL: COPPER
- WIRE RANGE: 22-16A.W.G. (0.5-1.5mm²)

Tolerance Unless Otherwise Specified	
0 >	MM ± ANGLE
>	MM ± 0° REF ±
>	MM ± ° ±
>	MM ± ° ±

NAME	VINYL-INSULATED RING TERMINALS			UNIT	mm	
PART NO.	RVY1-8@	MATERIAL		APPROVE		
NUMBER	TZV-190	SCALE	SHEET PAGE	CHECKED		
DATE	09/06/2005	3 : 1	1-0 1 OF 1	DRAWN		