

LTM4700 Single 100A μ Module Regulator with Digital Power System Management

DESCRIPTION

Demonstration circuit 2702B-B is a single output, dual-phase, high efficiency, high density, μ Module[®] regulator with a 4.5V to 16V input range. The output voltage is adjustable from 0.5V to 1.8V and can supply 100A maximum load current. The DC2702B-B demo board has a [LTM[®]4700](#) μ Module regulator, a dual 50A or single 100A step-down regulator with digital power system management. Refer to the LTM4700 data sheet for more detailed information.

DC2702B-B powers up to default settings and produces power based on configuration resistors without serial bus communication. This feature allows easy evaluation of the DC/DC converter. To fully explore the extensive power system management features of the LTM4700, download

the GUI software LTpowerPlay[®] onto your PC and use Analog Devices I²C/SMBus/PMBus dongle [DC1613A](#) to connect to the board. LTpowerPlay allows the user to reconfigure the part on-the-fly, store the configuration in EEPROM, view telemetry of voltage, current, temperature and fault status.

Graphic User Interface (GUI) Download

The software can be downloaded from [LTpowerPlay](#).

For more details and instructions on LTpowerPlay, refer to LTpowerPlay GUI for LTM4700 Quick Start Guide.

[Design files for this circuit board are available.](#)

All registered trademarks and trademarks are the property of their respective owners.

BOARD PHOTO Part marking is either ink mark or laser mark

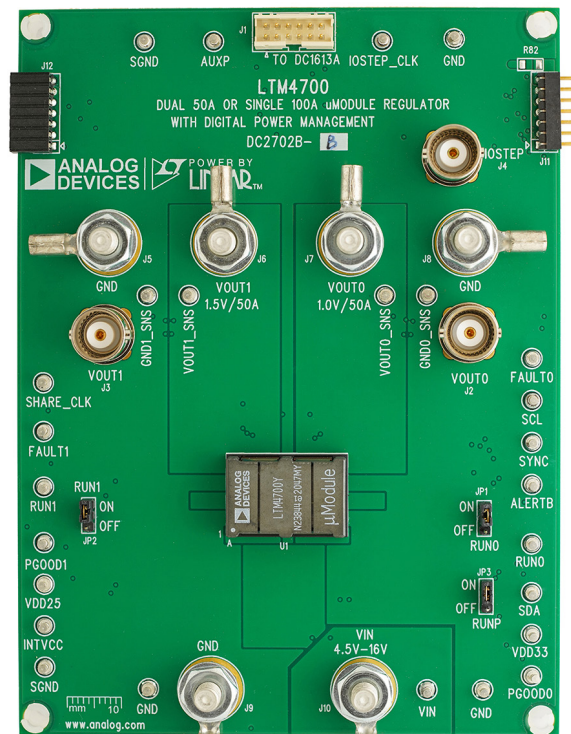

Figure 1. Single Output LTM4700/DC2702B-B Demo Circuit

DEMO MANUAL DC2702B-B

PERFORMANCE SUMMARY Specifications are at $T_A = 25^\circ\text{C}$

PARAMETER	CONDITIONS	MIN	TYP	MAX	UNITS
Input Voltage Range		4.5		16	V
Output Voltage, V_{OUT0}	$V_{IN} = 4.5\text{V to }16\text{V}$, $I_{OUT0} = 0\text{A to }100\text{A}$	0.5	1.0	1.8	V
Maximum Output Current, I_{OUT0}	$V_{IN} = 4.5\text{V to }16\text{V}$, $V_{OUT0} = 0.5\text{V to }1.8\text{V}$		100		A
Typical Efficiency	$V_{IN} = 12\text{V}$, $V_{OUT0} = 1.0\text{V}$, $I_{OUT0} = 100\text{A}$		88.7 (See Figure 5)		%
Default Switching Frequency			350		kHz

QUICK START PROCEDURE

MAXIMUM OUTPUT CURRENT	NUMBER OF OUTPUTS	NUMBER OF LTM4700 μ Module REGULATORS ON THE BOARD	DEMO BOARD NUMBER
50A	2	1	DC2702B-A
100A	1	1	DC2702B-B
200A	1	2	DC2784B-A
300A	1	3	DC2784B-B
400A	1	4	DC2784B-C

Demonstration circuit 2702B-B is easy to set up to evaluate the performance of the LTM4700EY. See Figure 2 for the proper measurement equipment setup and follow the procedure below.

1. With power off, connect the input power supply to V_{IN} (4.5V to 16V) and GND (input return).
2. Connect the 1.0V output load between V_{OUT0} and GND (Initial load: no load).
3. Connect the Digital Voltmeters (DVMs) to the input and outputs. Set default jumper position:
JP1: ON
JP2: ON
JP3: ON
4. Turn on the input power supply and check for the proper output voltages. V_{OUT0} should be $1.0\text{V} \pm 0.5\%$.

5. Once the proper output voltages are established, adjust the loads within the operating range and observe the output voltage regulation, ripple voltage and other parameters.
6. Connect the dongle and control the output voltages from the GUI. For more details, refer to the LTpowerPlay GUI for the LTM4700 Quick Start Guide.

Notes

The internal bias circuit is enabled when $V_{IN} > 7\text{V}$ and JP3 is ON.

When measuring the output or input voltage ripple, do not use the long ground lead on the oscilloscope probe. See Figure 3 for the proper scope probe technique. Short, stiff leads need to be soldered to the (+) and (-) terminals of an output capacitor. The probe's ground ring needs to touch the (-) lead, and the probe tip needs to touch the (+) lead.

QUICK START PROCEDURE

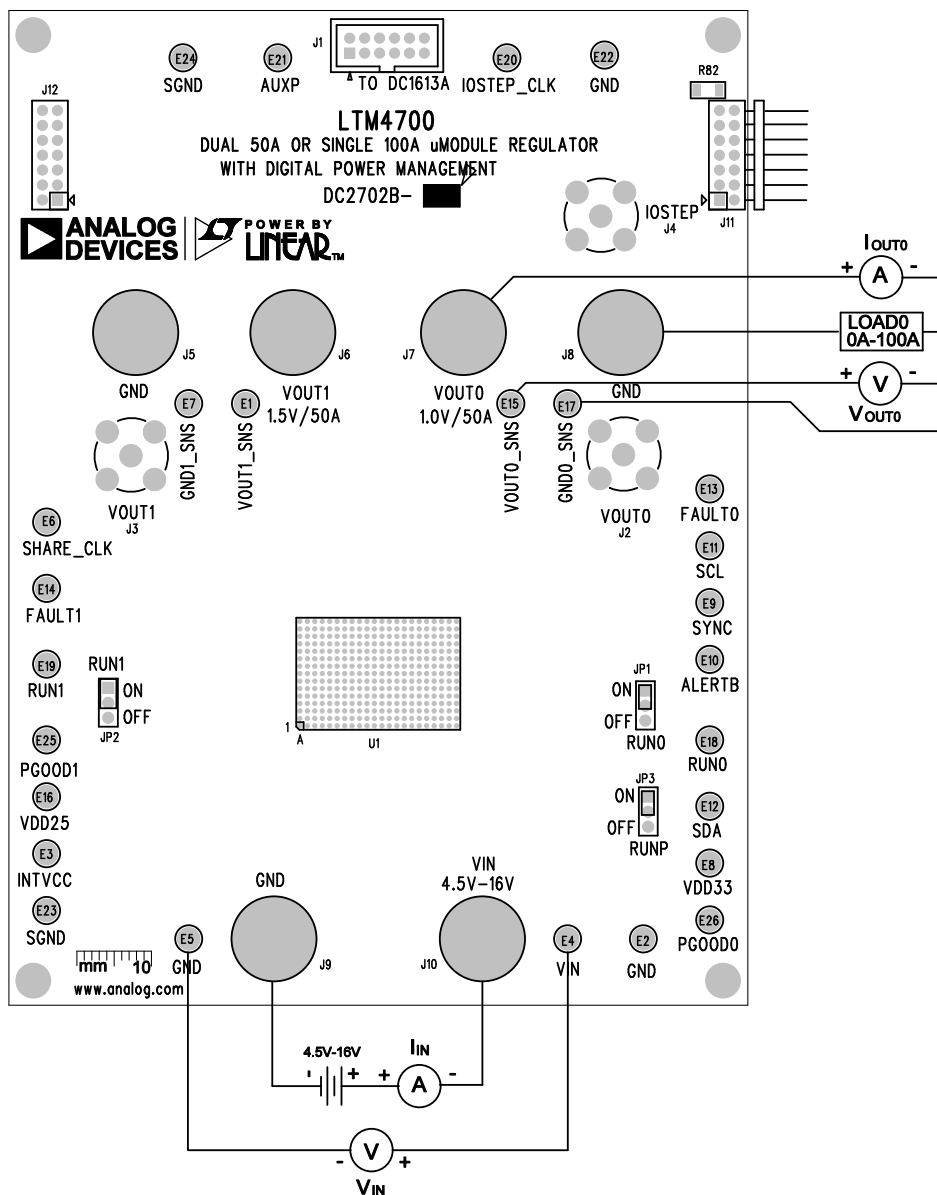

Figure 2. Proper Measurement Equipment Setup

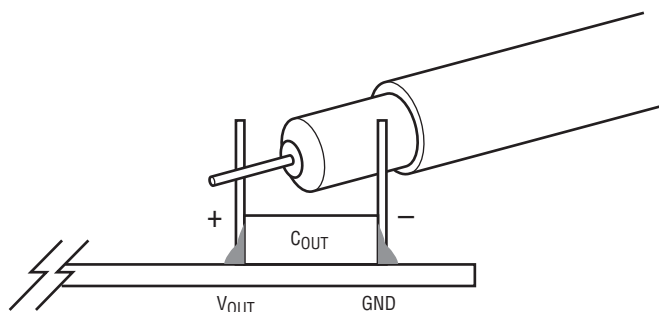

Figure 3. Measuring Output Voltage Ripple

QUICK START PROCEDURE

Connecting a PC to DC2702B-B

A Personal Computer (PC) can be used to reconfigure the power management features of the LTM4700, such

as nominal V_{OUT} , margin set points, OV/UV limits, temperature fault limits, sequencing parameters, the fault log, fault responses, GPIOs and other functionalities. The DC1613A dongle may be plugged in when V_{IN} is present.

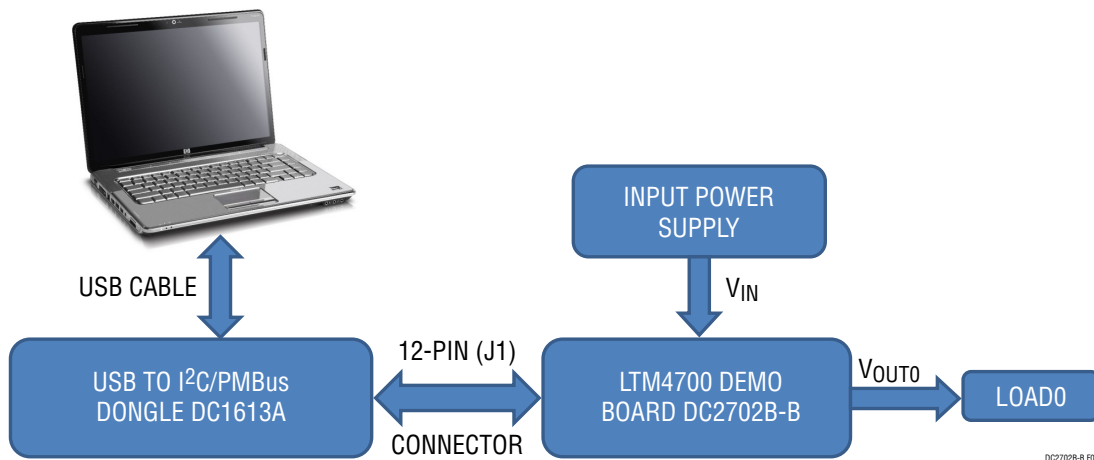

Figure 4. Demo Setup with PC

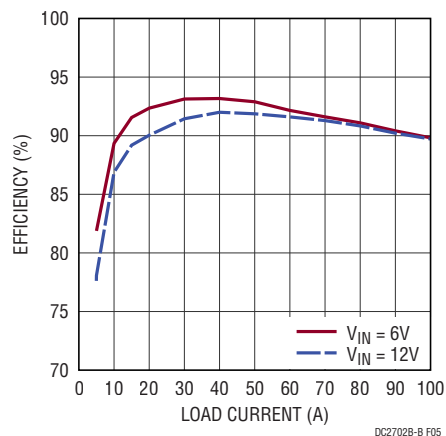

Figure 5. Efficiency vs Load Current at $V_{OUT0} = 1V$, $f_{SW} = 350kHz$ (RUNP is ON)

QUICK START PROCEDURE

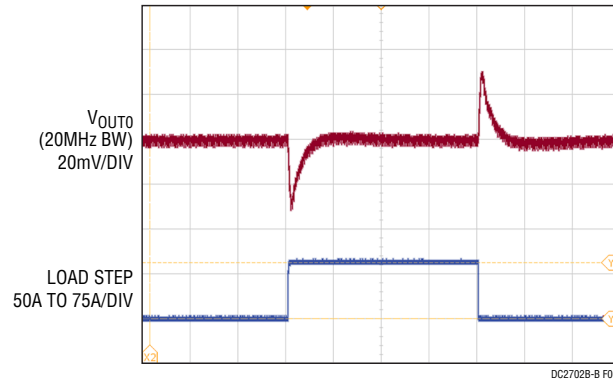

Figure 6. Output Voltage V_{OUT0} vs Load Current ($V_{OUT0} = 1.0V$)

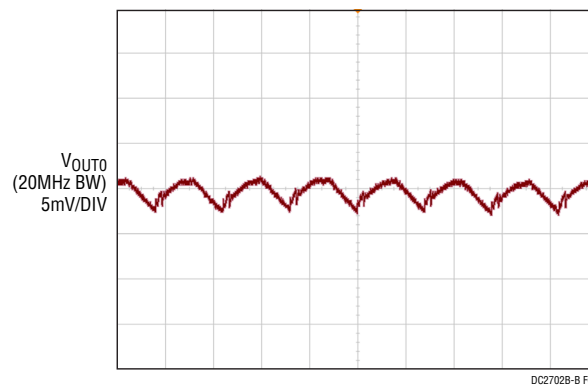

Figure 7. Output Voltage Ripple at $V_{IN} = 12V$, $V_{OUT0} = 1.0V$, $I_{OUT0} = 100A$

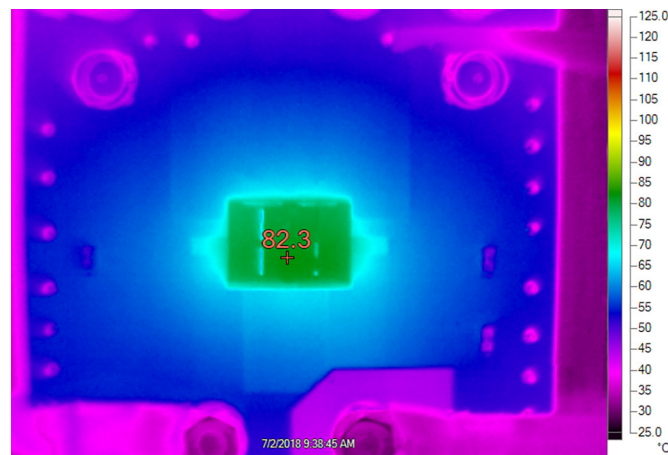

Figure 8. Thermal at $V_{IN} = 12V$, $V_{OUT0} = 1.0V$, $I_{OUT0} = 100A$, $T_A = 25^\circ C$, No Airflow

LTpowerPlay SOFTWARE GUI

LTpowerPlay is a powerful Windows-based development environment that supports Analog Devices power system management ICs and μ Module ICs, including the LTM4675, LTM4676, LTM4677, LTM4678, LTC3880, LTC3882 and LTC3883. The software supports a variety of different tasks. You can use LTpowerPlay to evaluate Analog Devices ICs by connecting to a demo board system. LTpowerPlay can also be used in an offline mode (with no hardware present) to build a multichip configuration file that can be saved and reloaded later. LTpowerPlay provides unprecedented diagnostic and debug features. It becomes a valuable diagnostic tool during board bring-up to program or tweak the power management scheme

in a system, or to diagnose power issues when bringing up rails. LTpowerPlay utilizes the DC1613A USB-to-SMBus controller to communicate with one of many potential targets, including the LTM4675, LTM4676, LTM4677, LTM4678, LTC3880, LTC3882, LTC3883's demo system, or a customer board. The software also provides an automatic update feature to keep the software current with the latest set of device drivers and documentation. The LTpowerPlay software can be downloaded from [LTpowerPlay](#).

To access technical support documents for Analog Devices' Digital Power Products, visit the LTpowerPlay Help menu. Online help is also available through the LTpowerPlay.

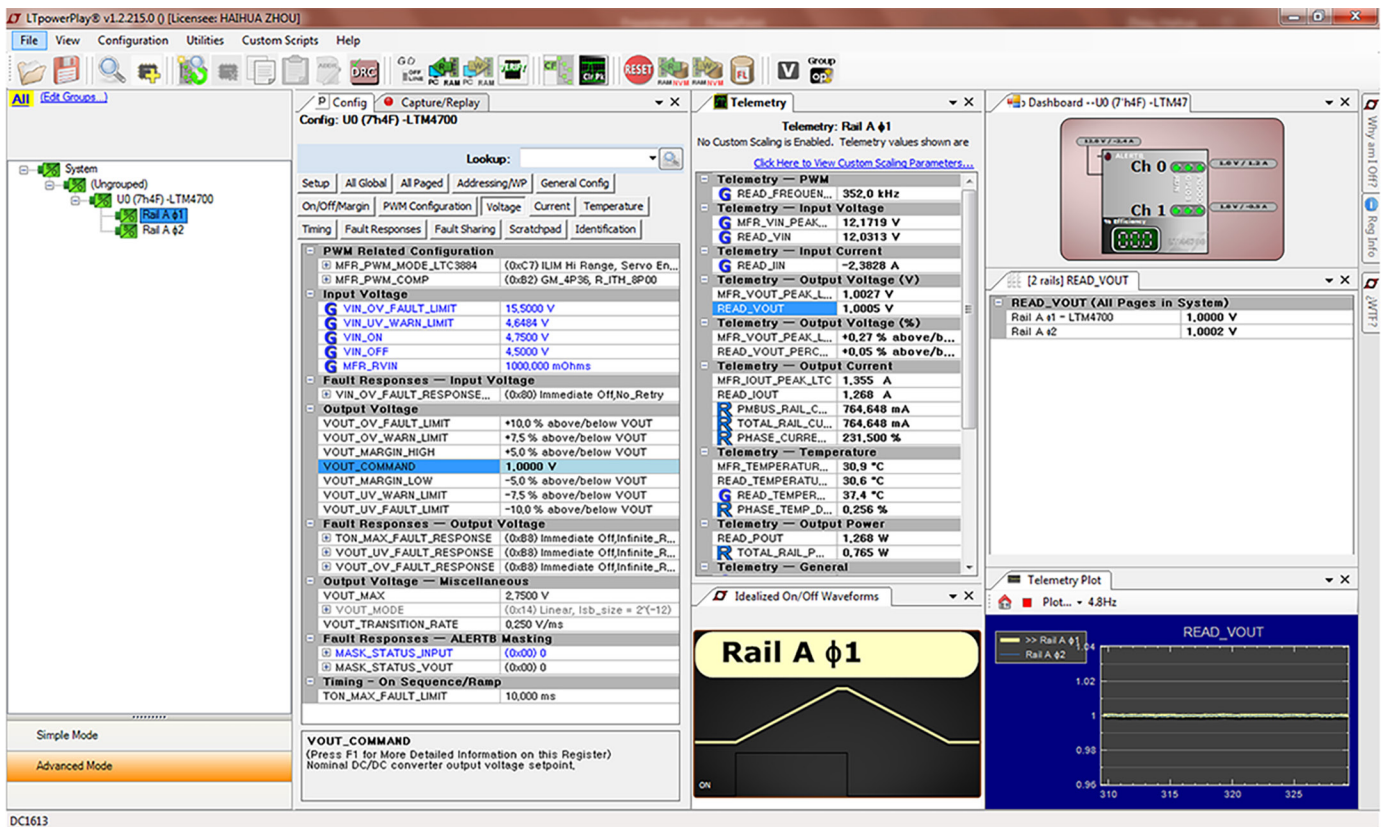
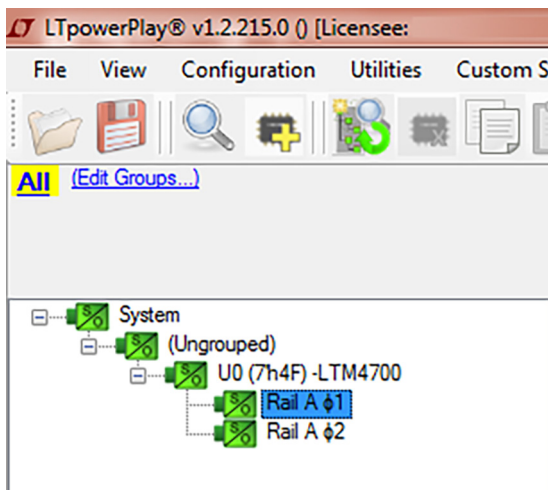

Figure 9. LTpowerPlay Main Interface

LTpowerPlay QUICK START PROCEDURE

The following procedure describes how to use LTpowerPlay to monitor and change the settings of LTM4700.

1. Download and install the [LTpowerPlay GUI](#).
2. Launch the LTpowerPlay GUI.
 - a. The GUI should automatically identify the DC2702B-B. The system tree on the left-hand side should look like as shown in the following figure:



- b. A green message box shows for a few seconds in the lower left-hand corner, confirming that LTM4700 is communicating:

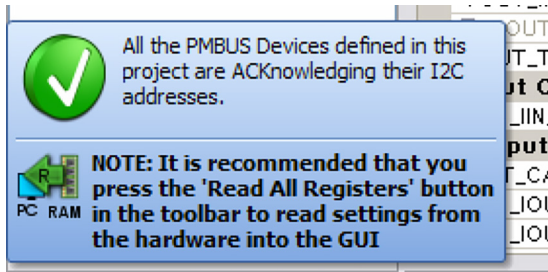

- c. In the toolbar, click the “R” (RAM to PC) icon to read the RAM from the LTM4700. This step reads the configuration from the RAM of LTM4700 and loads it into the GUI.



- d. If you want to change the output voltage to a different value, 0.8V. In the Config tab, type in 0.8 in the VOUT_COMMAND box as shown in the following figure:

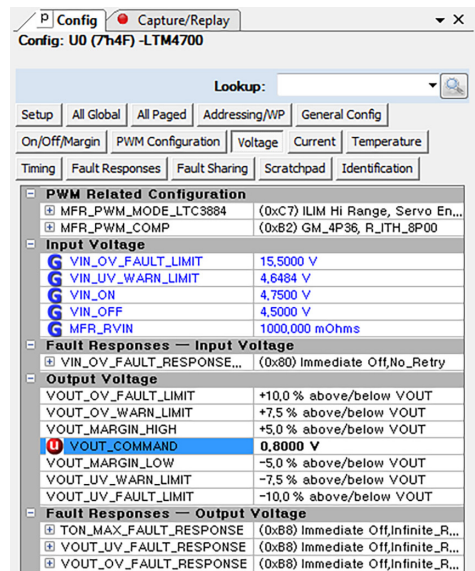

- e. Then, click the “W” (PC to RAM) icon to write these register values to the LTM4700. After finishing this step, the output voltage changes to 0.8V.



- f. If the write is successful, the following message will be seen:

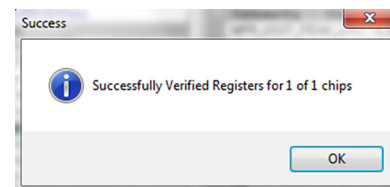

- g. Changes can be saved into the NVM. In the toolbar, click the “RAM to NVM” button:



- h. Save the demo board configuration to a (*.proj) file. Click the Save icon and save the file.

DEMO MANUAL DC2702B-B

PARTS LIST

ITEM	QTY	REFERENCE	PART DESCRIPTION	MANUFACTURER/PART NUMBER
Required Circuit Components				
1	18	COUT1-COUT10, COUT14-COUT16, COUT18-COUT22	CAP, 330 μ F, X6S, 4V, 20%, 1210	TAIYO YUDEN, AMK325AC6337MM-P
2	1	CIN1	CAP, 180 μ F, ALUM. POLY., 25V, 20%, 8mm \times 12mm SMD, E12	PANASONIC, 25SVPF180M
3	1	C15	CAP, 6800pF, X7R, 50V, 5%, 0603	AVX, 06035C682JAT2A
4	8	CIN2-CIN9	CAP, 22 μ F, X5R, 25V, 10%, 1210	AVX, 12103D226KAT2A MURATA, GRM32ER61E226KE15L TAIYO YUDEN, TMK325BJ226KM-P TAIYO YUDEN, TMK325BJ226KM-T
5	3	C21, C22, C24	CAP, 1 μ F, X5R, 25V, 10%, 0603	AVX, 06033D105KAT2A NIC, NMC0603X5R105K25TRPF
6	1	C23	CAP, 1 μ F, X7R, 25V, 10%, 0805	AVX, 08053C105KAT2A
7	1	C26	CAP, 0.1 μ F, X5R, 16V, 10%, 0603	AVX, 0603YD104KAT2A NIC, NMC0603X5R104K16TRPF
8	2	C27, C28	CAP, 0.01 μ F, X7R, 25V, 5%, 0603	AVX, 06033C103JAT2A
9	1	C33	CAP, 22 μ F, X5R, 6.3V, 20%, 0603	MURATA, GRM188R60J226MEA0D
10	2	Q1, Q2	XSTR., MOSFET, N-CH, 40V, TO-252 (DPAK)	VISHAY, SUD50N04-8M8P-4GE3
11	1	Q3	XSTR., MOSFET, P-CH, 20V, 5.9A, TO-236 (SOT23-3)	VISHAY, SI2365EDS-T1-GE3
12	15	R10-R16, R18, R19, R24, R52, R77, R94, R95, R106	RES., 10k, 5%, 1/10W, 0603, AEC-Q200	NIC, NRC06J103TRF PANASONIC, ERJ3GEYJ103V VISHAY, CRCW060310K0JNEA
13	4	R25, R32, R69, R70	RES., 10 Ω , 1%, 1/10W, 0603	NIC, NRC06F10R0TRF PANASONIC, ERJ3EKF10R0V ROHM, MCR03EZPFX10R0 VISHAY, CRCW060310R0FKEA YAGEO, RC0603FR-0710RL
14	2	R30, R31	RES., 2.43k, 1%, 1/10W, 0603, AEC-Q200	NIC, NRC06F2431TRF PANASONIC, ERJ3EKF2431V VISHAY, CRCW06032K43FKEA
15	2	R50, R51	RES., 30 Ω , 1%, 1W, 2512, AEC-Q200	VISHAY, CRCW251230R0FKEG
16	1	R53	RES., 0.01 Ω , 1%, 1/2W, 2010, SENSE, AEC-Q200	VISHAY, WSL2010R0100FEA
17	2	R72, R73	RES., 4.99k, 1%, 1/10W, 0603, AEC-Q200	NIC, NRC06F4991TRF PANASONIC, ERJ3EKF4991V VISHAY, CRCW06034K99FKEA
18	1	R78	RES., 15.8k, 1%, 1/10W, 0603, AEC-Q200	NIC, NRC06F1582TRF PANASONIC, ERJ3EKF1582V VISHAY, CRCW060315K8FKEA
19	1	R90	RES., 0.001 Ω , 1%, 1W, 2010, HP METAL, SENSE, AEC-Q200	VISHAY, WSL20101L000FEA18
20	1	U1	IC, DUAL 50A POP PSM MODULE, BGA 15mm \times 22mm \times 7.82mm	ANALOG DEVICES, LTM4700EY#PBF
21	1	U2	IC, MEMORY, EEPROM, 2KBIT (256mm \times 8mm), TSSOP-8, 400kHz	MICROCHIP, 24LC025-I/ST MICROCHIP, 24LC025T-I/ST

PARTS LIST

ITEM	QTY	REFERENCE	PART DESCRIPTION	MANUFACTURER/PART NUMBER
Additional Demo Board Circuit Components				
1	0	C1, C2, C14, C16, C17, C29, C31, C32	CAP, OPTION, 0603	
2	0	D1, D2	DIODE, OPTION, SOD-323	
3	0	R3, R8, R26, R27, R61, R62, R64, R67, R68, R74, R75, R83, R88, R89, R93	RES., OPTION, 0603	
4	16	R9, R28, R29, R33, R35, R38, R41, R63, R65, R66, R91, R92, R96-R99	RES., 0 Ω , 1/10W, 0603, AEC-Q200	NIC, NRC06ZOTRF VISHAY, CRCW06030000Z0EA
5	5	R48, R100-R103	RES., 0 Ω , 3/4W, 2010, AEC-Q200	NIC, NRC50ZOTRF PANASONIC, ERJ12ZY0R00U VISHAY, CRCW20100000Z0EF
6	0	R49	RES., OPTION, 2010	
7	0	R82	RES., OPTION, 1206	
8	0	R104, R105	RES., OPTION, 0805	
Hardware				
1	26	E1-E26	TEST POINT, TURRET, 0.064", MTG. HOLE	MILL-MAX, 2308-2-00-80-00-00-07-0
2	3	JP1, JP2	CONN., HDR, MALE, 1mm x 3mm x 2mm, VERT, STR, THT	WURTH ELEKTRONIK, 62000311121
3	1	J1	CONN., SHROUDED HDR, MALE, 2 x 6, 2mm, VERT, STR, THT	FCI, 98414-G06-12ULF
4	3	J2, J3, J4	CONN., RF BNC, RCPT JACK, 5-PIN, STR, THT, 50 Ω	AMPHENOL RF, 112404
5	6	J5-J10	STUD, FASTENER, #10-32s	PENNINGENGINEERING, KFH-032-10ET
6	12	J5-J10	NUT, HEX, STEEL, ZINC PLATE, 10-32	KEYSTONE, 4705
7	6	J5-J10	RING, LUG, CRIMP, #10, NONINSULATED, SOLDERLESS TERMINALS	KEYSTONE, 8205
8	6	J5-J10	WASHER, FLAT, STEEL, ZINC PLATE, OD: 0.436 [11.1]	KEYSTONE, 4703
9	1	J11	CONN., HDR, MALE, 2 x 7, 2mm, R/A THT	MOLEX, 0877601416 MOLEX, 877601416
10	1	J12	CONN., HDR, FEMALE, 2 x 7, 2mm, R/A THT	SULLINS CONNECTOR SOLUTIONS, NPPN072FJFN-RC
11	4	MH1-MH4	STANDOFF, NYLON, SNAP-ON, 0.50"	WURTH ELEKTRONIK, 702935000
12	3	XJP1, XJP2	CONN., SHUNT, FEMALE, 2 POS, 2mm	WURTH ELEKTRONIK, 60800213421

DEMO MANUAL DC2702B-B

SCHEMATIC DIAGRAM

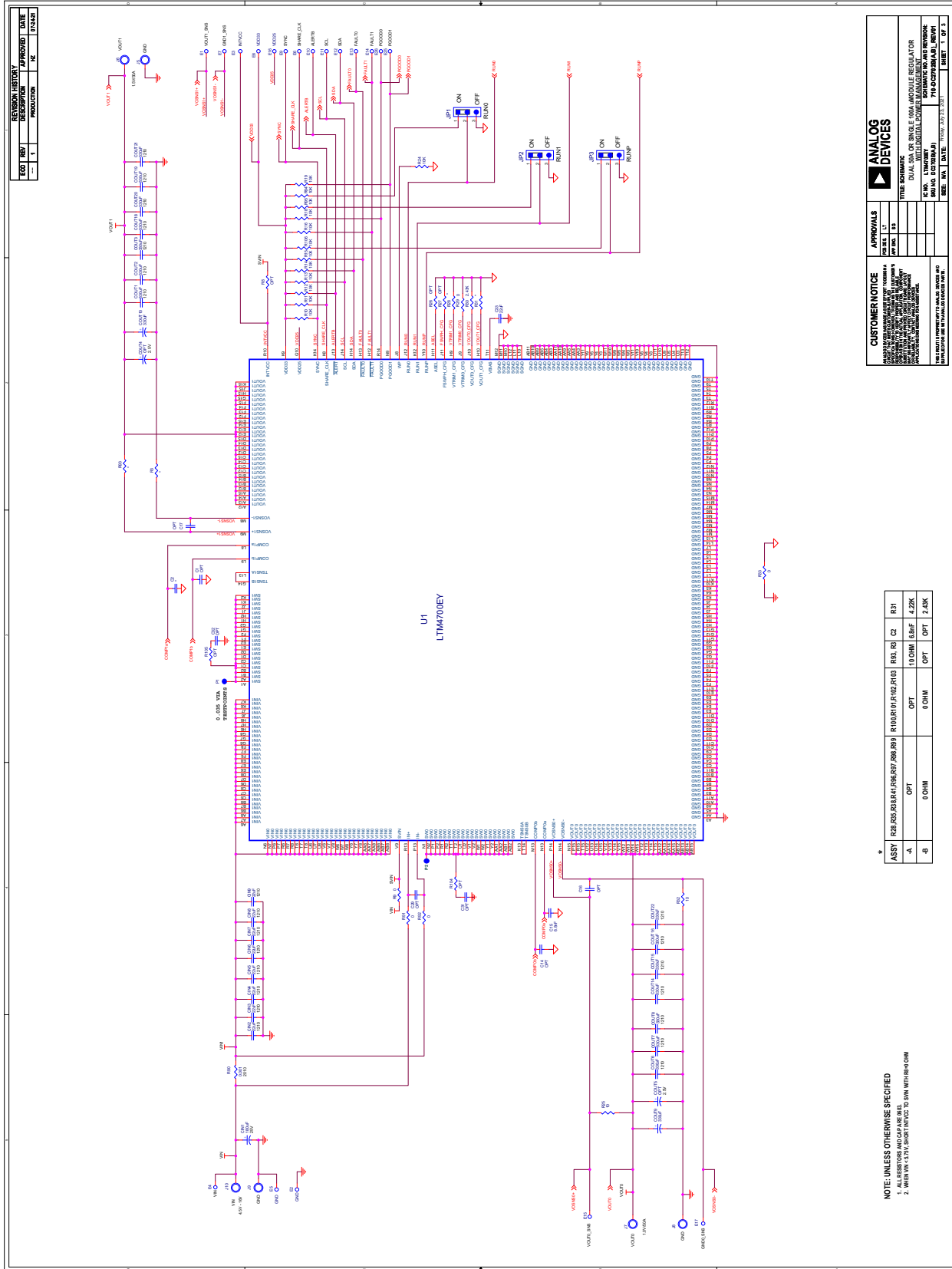

SCHEMATIC DIAGRAM

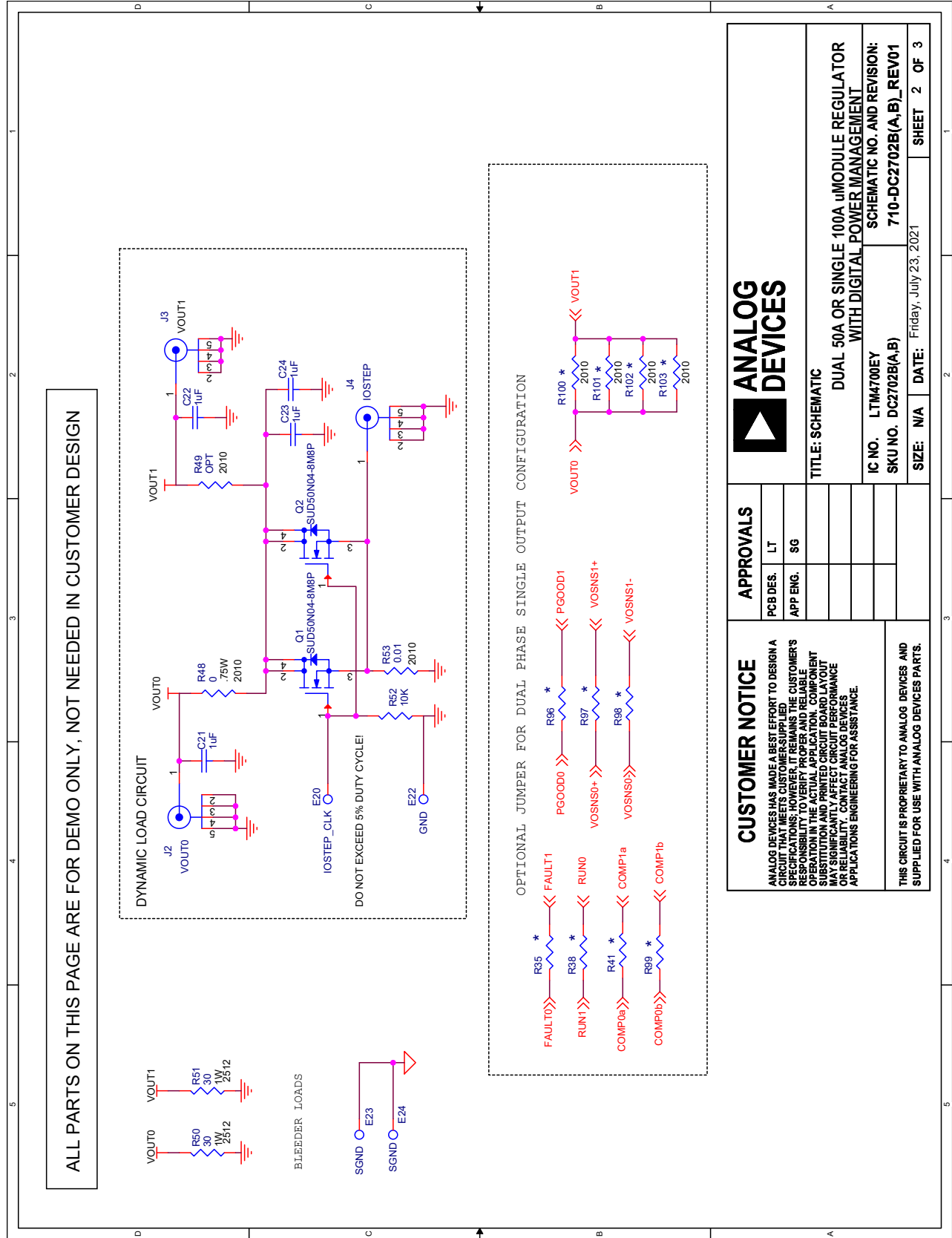

DEMO MANUAL DC2702B-B

SCHEMATIC DIAGRAM

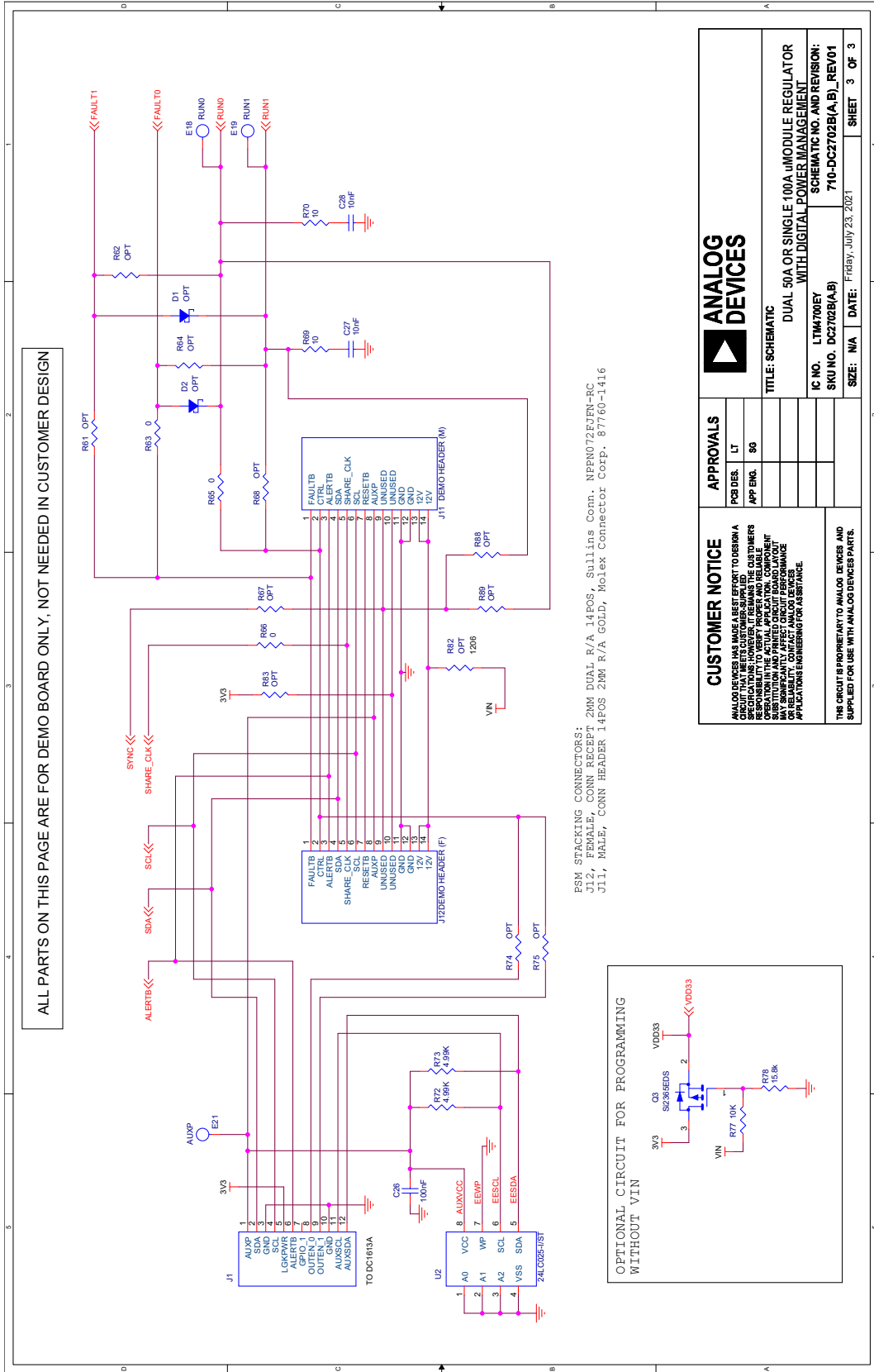

REVISION HISTORY

REV	DATE	DESCRIPTION	PAGE NUMBER
0	06/23	Initial Release.	—



ESD Caution

ESD (electrostatic discharge) sensitive device. Charged devices and circuit boards can discharge without detection. Although this product features patented or proprietary protection circuitry, damage may occur on devices subjected to high energy ESD. Therefore, proper ESD precautions should be taken to avoid performance degradation or loss of functionality.

Legal Terms and Conditions

By using the evaluation board discussed herein (together with any tools, components documentation or support materials, the "Evaluation Board"), you are agreeing to be bound by the terms and conditions set forth below ("Agreement") unless you have purchased the Evaluation Board, in which case the Analog Devices Standard Terms and Conditions of Sale shall govern. Do not use the Evaluation Board until you have read and agreed to the Agreement. Your use of the Evaluation Board shall signify your acceptance of the Agreement. This Agreement is made by and between you ("Customer") and Analog Devices, Inc. ("ADI"), with its principal place of business at One Technology Way, Norwood, MA 02062, USA. Subject to the terms and conditions of the Agreement, ADI hereby grants to Customer a free, limited, personal, temporary, non-exclusive, non-sublicensable, non-transferable license to use the Evaluation Board FOR EVALUATION PURPOSES ONLY. Customer understands and agrees that the Evaluation Board is provided for the sole and exclusive purpose referenced above, and agrees not to use the Evaluation Board for any other purpose. Furthermore, the license granted is expressly made subject to the following additional limitations: Customer shall not (i) rent, lease, display, sell, transfer, assign, sublicense, or distribute the Evaluation Board; and (ii) permit any Third Party to access the Evaluation Board. As used herein, the term "Third Party" includes any entity other than ADI, Customer, their employees, affiliates and in-house consultants. The Evaluation Board is NOT sold to Customer; all rights not expressly granted herein, including ownership of the Evaluation Board, are reserved by ADI. CONFIDENTIALITY. This Agreement and the Evaluation Board shall all be considered the confidential and proprietary information of ADI. Customer may not disclose or transfer any portion of the Evaluation Board to any other party for any reason. Upon discontinuation of use of the Evaluation Board or termination of this Agreement, Customer agrees to promptly return the Evaluation Board to ADI. ADDITIONAL RESTRICTIONS. Customer may not disassemble, decompile or reverse engineer chips on the Evaluation Board. Customer shall inform ADI of any occurred damages or any modifications or alterations it makes to the Evaluation Board, including but not limited to soldering or any other activity that affects the material content of the Evaluation Board. Modifications to the Evaluation Board must comply with applicable law, including but not limited to the RoHS Directive. TERMINATION. ADI may terminate this Agreement at any time upon giving written notice to Customer. Customer agrees to return to ADI the Evaluation Board at that time. LIMITATION OF LIABILITY. THE EVALUATION BOARD PROVIDED HEREUNDER IS PROVIDED "AS IS" AND ADI MAKES NO WARRANTIES OR REPRESENTATIONS OF ANY KIND WITH RESPECT TO IT. ADI SPECIFICALLY DISCLAIMS ANY REPRESENTATIONS, ENDORSEMENTS, GUARANTEES, OR WARRANTIES, EXPRESS OR IMPLIED, RELATED TO THE EVALUATION BOARD INCLUDING, BUT NOT LIMITED TO, THE IMPLIED WARRANTY OF MERCHANTABILITY, TITLE, FITNESS FOR A PARTICULAR PURPOSE OR NON-INFRINGEMENT OF INTELLECTUAL PROPERTY RIGHTS. IN NO EVENT WILL ADI AND ITS LICENSORS BE LIABLE FOR ANY INCIDENTAL, SPECIAL, INDIRECT, OR CONSEQUENTIAL DAMAGES RESULTING FROM CUSTOMER'S POSSESSION OR USE OF THE EVALUATION BOARD, INCLUDING BUT NOT LIMITED TO LOST PROFITS, DELAY COSTS, LABOR COSTS OR LOSS OF GOODWILL. ADI'S TOTAL LIABILITY FROM ANY AND ALL CAUSES SHALL BE LIMITED TO THE AMOUNT OF ONE HUNDRED US DOLLARS (\$100.00). EXPORT. Customer agrees that it will not directly or indirectly export the Evaluation Board to another country, and that it will comply with all applicable United States federal laws and regulations relating to exports. GOVERNING LAW. This Agreement shall be governed by and construed in accordance with the substantive laws of the Commonwealth of Massachusetts (excluding conflict of law rules). Any legal action regarding this Agreement will be heard in the state or federal courts having jurisdiction in Suffolk County, Massachusetts, and Customer hereby submits to the personal jurisdiction and venue of such courts. The United Nations Convention on Contracts for the International Sale of Goods shall not apply to this Agreement and is expressly disclaimed.