

Click [here](#) to ask about the production status of specific part numbers.

MAX25510/MAX25511

4-Channel, Low-Voltage, 120mA LED Backlight Drivers with Integrated Boost Converter

General Description

The MAX25510/MAX25511 are 4-channel, white-LED backlight drivers with an integrated current-mode boost converter that operate over a switching frequency range of 400kHz to 2.2MHz and incorporate spread spectrum. Phase-shifting of the output channels is included as an option to further reduce EMI.

The devices provide up to 120mA per channel and include a control output for an external nMOS series switch. These devices are capable of operating down to 3V after start-up.

The MAX25510 has a boost current limit of 3A (min), while the MAX25511 implements a higher minimum current limit of 4.5A for increased output power.

The MAX25510/MAX25511 are available in a compact TQFN package and operate over the temperature range -40°C to +125°C.

Applications

- Automotive Instrument Clusters
- Automotive Central Information Displays
- Automotive Head-Up Displays

Benefits and Features

- Operate down to 3V on Battery Input after Start-Up
 - Wide Boost Duty Cycle to Support Low Input Voltage
- Boost or SEPIC Current-Mode DC-DC Controller
 - 400kHz to 2.2MHz Operating Frequency Range
 - Spread Spectrum Available
 - Can Be Synchronized to an External Clock
- LED Current Sinks
 - Up to 120mA Output Current per String
 - Low OUT_ Regulation Voltage for Best Efficiency
 - Optional Phase-Shifting of Outputs
- 16667:1 Dimming Ratio at 200Hz
- NTC Input for LED Current Foldback
- Analog Dimming Capable
- Built-In Automatic Fading Functionality
- FLT_B Output Provides Diagnostic Information
 - Shorted or Open LEDs
 - Thermal Shutdown
 - Output Undervoltage
- Compact, 4mm x 4mm TQFN Package
- AEC-Q100 Grade 1

[Ordering Information](#) appears at end of data sheet.

Simplified Block Diagram

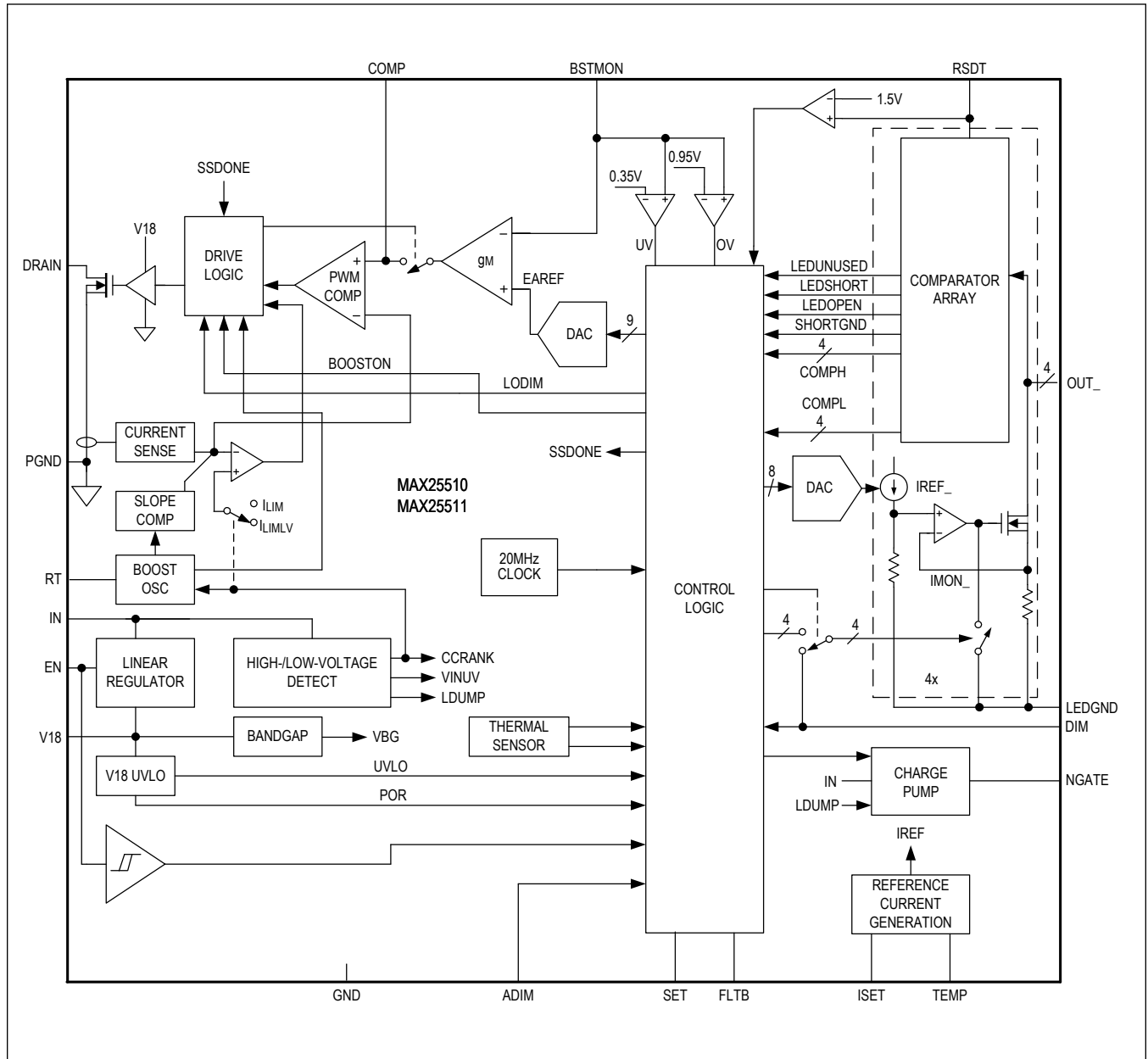

TABLE OF CONTENTS

General Description	1
Applications	1
Benefits and Features	1
Simplified Block Diagram	2
Absolute Maximum Ratings	7
Package Information	7
TQFN	7
Electrical Characteristics	7
Typical Operating Characteristics	12
Pin Configuration	14
Pin Description	14
Functional Diagrams	16
Detailed Description	17
Enable	17
Undervoltage Lockout	17
High-Voltage Operation	17
Low-Voltage Operation	17
SET Pin Operation	17
Current-Mode DC-DC Controller	18
Output Undervoltage Protection	18
9-Bit Digital-to-Analog Converter	18
LED Current Control	19
Dimming	19
Low-Dimming Mode	19
Phase-Shift Dimming	19
Automatic Fade-In/Fade-Out During Dimming	19
Disabling Individual Strings	20
ADIM Operation	20
Startup Sequence	20
Stage 1	21
Stage 2	21
Stage 3	21
Boost Startup	22
Oscillator Frequency/External Synchronization	22
Spread Spectrum	22
Fault Protection	23
Open-LED Management and Overvoltage Protection	23
Shorted-LED Detection	23
OUT_ Short-to-GND Detection	24

TABLE OF CONTENTS (CONTINUED)

Thermal Shutdown	24
Temperature Foldback	24
Above Temperature T_{OFF}	24
Applications Information	25
DC-DC Converter	25
Power-Circuit Design	25
Boost Configuration	25
SEPIC Configuration	26
Output Capacitor Selection	27
Rectifier Diode Selection	27
Feedback Compensation	27
External Disconnect MOSFET Selection	28
V_{OUT} to OUT_{-} Bleed Resistors	29
Thermal Considerations	29
PCB Layout Considerations	29
Typical Application Circuits	30
Boost Application	30
Ordering Information	31
Revision History	32

LIST OF FIGURES

Figure 1. ADIM Operation Curve	20
Figure 2. Boost Start-Up Waveforms	22
Figure 3. Temperature Foldback Curve	24

LIST OF TABLES

Table 1. Set Pin Resistor Values	17
Table 2. Temperature Foldback Sample Resistor Values	24

Absolute Maximum Ratings

IN, EN to GND	-0.3V to +40V	PGND to GND.....	-0.3V to +0.3V
NGATE to IN.....	+6V	LEDGND to GND	-0.3V to +0.3V
NGATE to GND	-0.3V to +42V	DRAIN Current.....	±4.5A
OUT_ to LEDGND.....	-0.3V to +40V	OUT_ Continuous Current	±150mA
DRAIN to PGND.....	-0.3V to +40V	Continuous Power Dissipation (Multilayer Board) (T _A = +70°C, derate 24.2mW/°C above +70°C.)	1938mW
V18, BSTMON to GND.....	-0.3V to +2.2V	Operating Temperature Range	-40°C to +125°C
FLTB, DIM, ADIM to GND	-0.3V to +6V	Junction Temperature	-40°C to +150°C
RT, COMP, ISET, TEMP, RSDT, SET to GND	-0.3V to V18 + 0.3V	Soldering Temperature (reflow)	+260°C

Stresses beyond those listed under "Absolute Maximum Ratings" may cause permanent damage to the device. These are stress ratings only, and functional operation of the device at these or any other conditions beyond those indicated in the operational sections of the specifications is not implied. Exposure to absolute maximum rating conditions for extended periods may affect device reliability.

Package Information

TQFN

Package Code	T2444+4C
Outline Number	21-0139
Land Pattern Number	90-0022
Thermal Resistance, Single-Layer Board:	
Junction to Ambient (θ _{JA})	48°C/W
Junction to Case (θ _{JC})	3°C/W
Thermal Resistance, Four-Layer Board:	
Junction to Ambient (θ _{JA})	36°C/W
Junction to Case (θ _{JC})	3°C/W

For the latest package outline information and land patterns (footprints), go to www.maximintegrated.com/packages. Note that a "+", "#", or "-" in the package code indicates RoHS status only. Package drawings may show a different suffix character, but the drawing pertains to the package regardless of RoHS status.

Package thermal resistances were obtained using the method described in JEDEC specification JESD51-7, using a four-layer board. For detailed information on package thermal considerations, refer to www.maximintegrated.com/thermal-tutorial.

Electrical Characteristics

(V_{IN} = V_{EN} = 12V, T_A = T_J = -40°C to +125°C, unless otherwise noted. Typical values are at T_A = +25°C, unless otherwise noted. (*Note 1*))

PARAMETER	SYMBOL	CONDITIONS	MIN	TYP	MAX	UNITS
POWER SUPPLY						
Operating Voltage Range	V _{IN}		4.5		36	V
Operating Voltage Range after Start-Up		Maximum duration 100ms	3		36	V
Supply Current	I _{IN}	No switching		1.3	1.8	mA
Shutdown Supply Current		V _{EN} = 0V, +25°C		0.1	5	µA
IN Undervoltage Lockout, Rising	V _{INUVR}		4.15	4.29	4.4	V
IN Undervoltage Lockout, Falling	V _{INUVF}		2.77	2.9	2.95	V

Electrical Characteristics (continued)

($V_{IN} = V_{EN} = 12V$, $T_A = T_J = -40^{\circ}C$ to $+125^{\circ}C$, unless otherwise noted. Typical values are at $T_A = +25^{\circ}C$, unless otherwise noted. ([Note 1](#)))

PARAMETER	SYMBOL	CONDITIONS	MIN	TYP	MAX	UNITS
Threshold for Low-Voltage Operation Mode, Falling	V_{LVF}		5.4	5.5	5.7	V
Threshold for Low-Voltage Operation Mode, Rising	V_{LVR}		5.55	5.72	5.85	V
V18 REGULATOR						
V18 Voltage			1.75	1.8	1.85	V
V18 Undervoltage Lockout, Rising	$UVLOVCCR$		1.6	1.65	1.69	V
V18 Undervoltage Lockout, Falling	$UVLOVCCF$		1.54	1.575	1.61	V
V18 Short-Circuit Current Limit	I_{SCV18}	V18 shorted to GND		50		mA
NGATE OUTPUT						
NGATE Source Current			30	50		μA
NGATE Sink Current			0.5	1		mA
NGATE Output Voltage		Above V_{IN} , $3V < V_{IN} < 33V$, $I_{NGATE} = 0\mu A$	4.3	5.25	6.3	V
		Above V_{IN} , $3V < V_{IN} < 33V$, $I_{NGATE} = 10\mu A$	3.8	4.6	6	
NGATE Output Voltage at High Input Voltage		Above V_{IN} , $V_{IN} > 35.5V$, $I_{NGATE} = 1\mu A$	-0.05		0	V
V_{IN} OV Comparator Threshold for NGATE, Rising	V_{LDUMP_TH}		33		35.5	V
V_{IN} OV Comparator Hysteresis for NGATE				0.7		V
NGATE Start Delay		Delay between NGATE charge-pump turning on and the boost converter starting		2	2.2	ms
RT OSCILLATOR						
Switching Frequency Range	f_{SW}	Frequency dithering disabled	400		2200	kHz
Oscillator Frequency Accuracy		$f_{SW} = 400kHz$ to $2200kHz$, frequency dithering disabled	-10		10	%
Boost Converter Maximum Duty Cycle, High Frequency		1.3MHz to 2.2MHz	89	92	95	%
Boost Converter Maximum Duty Cycle, Low Frequency		$f_{SW} = 400kHz$ to 1.3MHz	94		98	%
Boost Minimum On-Time				60		ns
Frequency Dither				± 6		%

Electrical Characteristics (continued)

($V_{IN} = V_{EN} = 12V$, $T_A = T_J = -40^{\circ}C$ to $+125^{\circ}C$, unless otherwise noted. Typical values are at $T_A = +25^{\circ}C$, unless otherwise noted. ([Note 1](#)))

PARAMETER	SYMBOL	CONDITIONS	MIN	TYP	MAX	UNITS	
RT Output Voltage	V_{RT}	$R_{RT} = 65k\Omega$ or $R_{RT} = 10k\Omega$		0.9		V	
RT Out-of-Range Lower Limit				5	6.4	k Ω	
RT Out-of-Range Upper Limit			90	111		k Ω	
Sync Falling Threshold			0.77		0.84	V	
Sync Frequency Duty-Cycle Range				50		%	
Sync Frequency Range			400		2200	kHz	
MOSFET							
DRAIN MOSFET $R_{DS(ON)}$		$I_{DRAIN} = 1A$		0.075	0.125	Ω	
DRAIN Leakage Current		$V_{DRAIN} = 36V$, $T_A = +25^{\circ}C$		0.03	1	μA	
CURRENT-SENSE COMPARATOR							
Current-Limit Threshold at Low Input Voltage	I_{LIMLV}	MAX25510	5.9	7	8.1	A	
		MAX25511	8.1	9.1	9.8		
Current-Limit Threshold	I_{LIM}	MAX25510	3	3.8	4.6	A	
		MAX25511	4.3	5.3	6		
ERROR AMPLIFIER							
OUT_ Regulation High Threshold	V_{OUTH}	$V_{OUT_falling}$	0.825	0.85	0.875	V	
OUT_ Regulation Low Threshold	V_{OUTL}	V_{OUT_rising}	0.55	0.58	0.61	V	
Transconductance			410	630	890	μS	
COMP Sink Current		$V_{COMP} = 1V$	270	380	500	μA	
COMP Source Current		$V_{COMP} = 1V$	270	380	500	μA	
LED CURRENT SINKS							
ISET Output Voltage	V_{ISET}			0.75		V	
OUT_ Output Current		$R_{ISET} = 12.5k\Omega$	120mA setting	116	120	124	mA
		$R_{ISET} = 15k\Omega$	100mA setting	97	100	103	
		$R_{ISET} = 30k\Omega$	50mA setting	48	50	52	
Channel-to-Channel Matching		$I_{OUT_} = 120mA$		-2	2.2	%	
		$I_{OUT_} = 50mA$		-3.25	3.25		
Total OUT_ Leakage Current	$I_{OUTLEAK}$	$V_{OUT_} = 36V$, $DIM = 0V$, all OUT_ are shorted together		0.01	4	μA	
OUT_ Minimum Pulse Width				300		ns	
OUT_ Minimum Negative Pulse Width				90		ns	
OUT_ Current Rise Time		10% to 90% $I_{OUT_}$ (Note 2)		150		ns	

Electrical Characteristics (continued)

($V_{IN} = V_{EN} = 12V$, $T_A = T_J = -40^{\circ}C$ to $+125^{\circ}C$, unless otherwise noted. Typical values are at $T_A = +25^{\circ}C$, unless otherwise noted. ([Note 1](#)))

PARAMETER	SYMBOL	CONDITIONS	MIN	TYP	MAX	UNITS
OUT_ Current Fall Time		90% to 10% $I_{OUT_}$ (Note 2)		30		ns
OVERVOLTAGE AND UNDERVOLTAGE PROTECTION						
BSTMON Overvoltage Trip Threshold	V_{BST_OV}	V_{BSTMON} rising	0.93	0.95	0.97	V
BSTMON Hysteresis				50		mV
BSTMON Input Bias Current		$0 < V_{BSTMON} < 1.3V$	-1		+1	μA
BSTMON Undervoltage Detection Threshold, Rising	$V_{BST_UVR,N}$	Normal soft-start	384	400	416	mV
	$V_{BST_UVR,F}$	Fast soft-start	720	750	780	
BSTMON Undervoltage Detection Threshold, Falling	V_{BST_UVF}	BSTMON falling, NGATE latched off	0.335	0.35	0.363	V
Boost Undervoltage Blanking Time, Standard Soft-Start		After EN pin taken high	49	53.25	57.5	ms
Boost Undervoltage Blanking Time, Fast Soft-Start		After EN pin taken high	26.18	28.46	30.74	ms
BSTMON Undervoltage Detection Delay	$t_{BST_UV_DEL}$	BSTMON falling	4	10	18	μs
LED FAULT DETECTION						
Maximum LED Short-Detection Threshold		$V_{RSDT} = 833mV$ rising	9.7	10	10.3	V
LED Short-Detection Threshold		$V_{RSDT} = 0.667V$	7.5	8	8.5	V
Minimum LED Short-Detection Threshold		$V_{RSDT} = 200mV$ rising	2.25	2.4	2.5	V
LED Short Disable Threshold		All active OUT_S rising	1.9	2	2.15	V
RSDT Pin Voltage Range			0.2		1	V
RSDT Disable Threshold			1.45	1.5	1.55	V
RSDT Pin Bias Current			-5		+5	μA
Short-Detection Comparator Delay	t_{SD_DEL}			6.8		μs
OUT_ Check LED Source Current	I_{CHKLED}		50	60	70	μA
OUT_ Short to GND Detection Falling Threshold	V_{TH_SGND}	Before boost converter start-up	230	250	270	mV
OUT_ Unused Detection Threshold	V_{TH_UNUSED}		0.775	0.85	0.925	V

Electrical Characteristics (continued)

($V_{IN} = V_{EN} = 12V$, $T_A = T_J = -40^{\circ}C$ to $+125^{\circ}C$, unless otherwise noted. Typical values are at $T_A = +25^{\circ}C$, unless otherwise noted. (*Note 1*))

PARAMETER	SYMBOL	CONDITIONS	MIN	TYP	MAX	UNITS
OUT_ Open-LED Detection Threshold	V_{OOL}	During operation	230	250	270	mV
LOGIC INPUT AND OUTPUTS						
DIM, ADIM Input Logic-High			1.6			V
DIM, ADIM Input Logic-Low					0.4	V
DIM, ADIM Input Leakage Current			-1		+1	μA
EN Input Logic-High			0.9			V
EN Input Logic-Low					0.6	V
EN Input Current		$V_{EN} = 5V$		0.01	1	μA
Minimum EN Pulse Width for Device Enable	t_{EN_ON}		5			ms
EN Turn-Off Delay	t_{EN_OFF}	Time between EN going low and complete device shutdown	11.5	12.8	14.1	ms
DIM Frequency Range			90		50000	Hz
DIM Sampling Frequency				20		MHz
ADIM Input Frequency Range			10		1000	kHz
FLTB Output Low Voltage		Sinking 3mA			0.4	V
FLTB Output Leakage Current		$V_{FLTB} = 5.5V$	-1		1	μA
SET, TEMP PINS						
SET Resistor Value Maximum Variation			-3.4		+3.4	%
TEMP Pin Voltage			180	200	220	mV
TEMP to ISET Gain		$V_{TEMP} < 250mV$	13.7	14.3	14.9	V/mA
TEMP Pin Disable Threshold				0.25		V
TEMP Pin Leakage Current		$+25^{\circ}C$		0.005	1	μA
ISET Voltage Threshold for LED Current Disable	V_{TEMPD}		125	150	175	mV
THERMAL SHUTDOWN						
Thermal-Shutdown Threshold	T_{SHDN}			160		$^{\circ}C$
Thermal-Shutdown Hysteresis				17		$^{\circ}C$

Note 1: Limits are 100% tested at $T_A = +25^{\circ}C$, $T_A = +125^{\circ}C$, and $T_A = -40^{\circ}C$. Limits over the operating temperature range and relevant supply voltage range are guaranteed by design and characterization.

Note 2: Guaranteed by design.

Typical Operating Characteristics

($V_{IN} = V_{EN} = 12V$, 4x9 LED load at 100mA, $f_{SW} = 2.2MHz$, $T_A = +25^\circ C$ unless otherwise noted.)

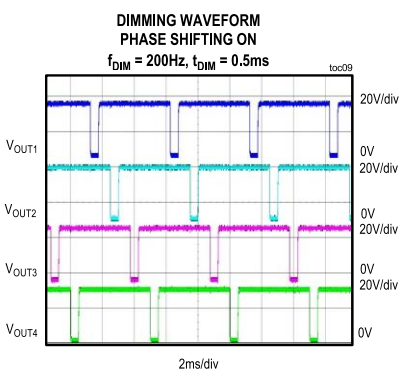
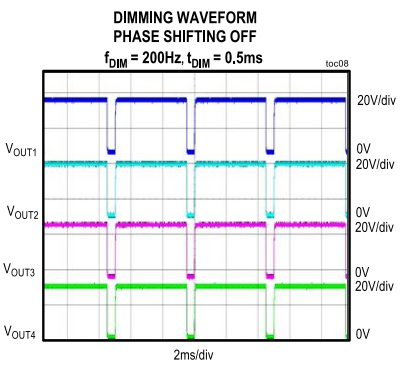
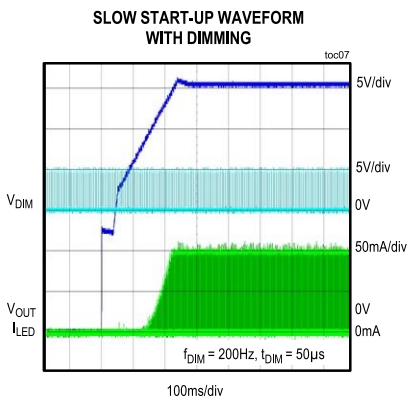
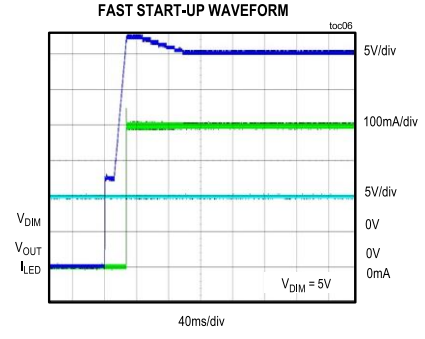
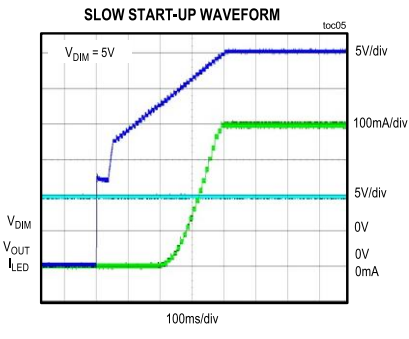
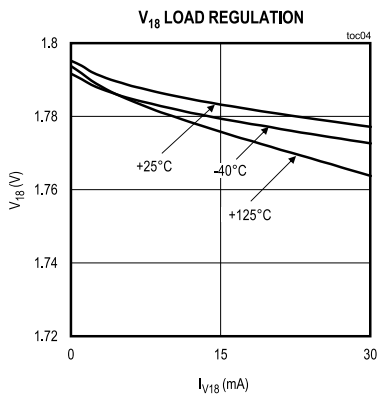
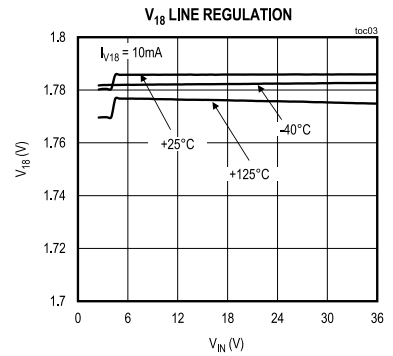
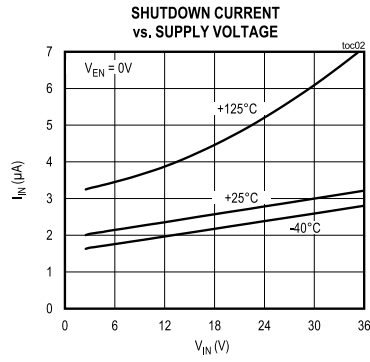
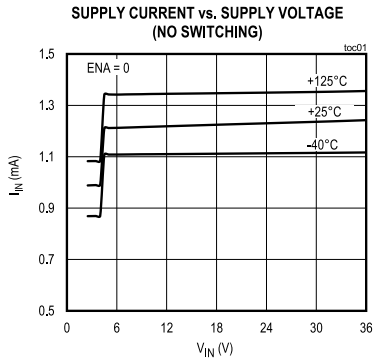

Typical Operating Characteristics (continued)

($V_{IN} = V_{EN} = 12V$, 4x9 LED load at 100mA, $f_{SW} = 2.2MHz$, $T_A = +25^\circ C$ unless otherwise noted.)

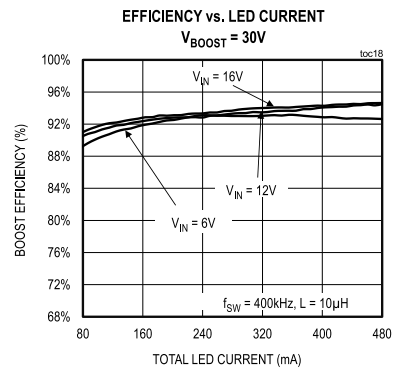
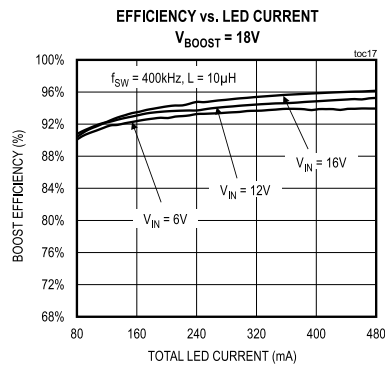
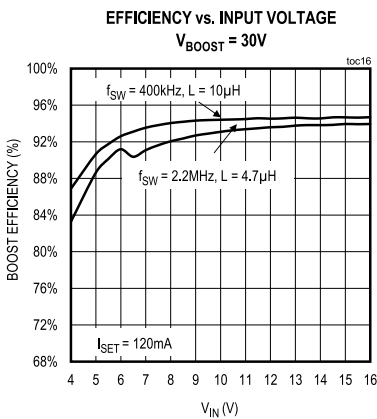
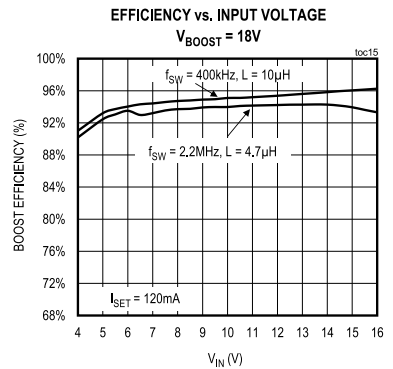
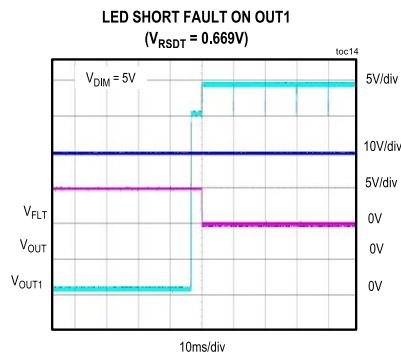
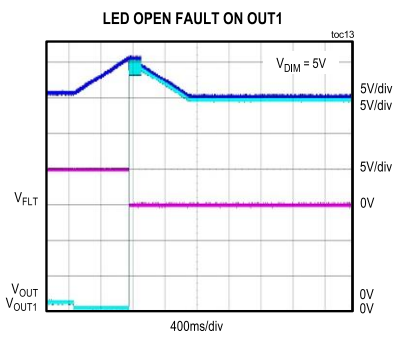
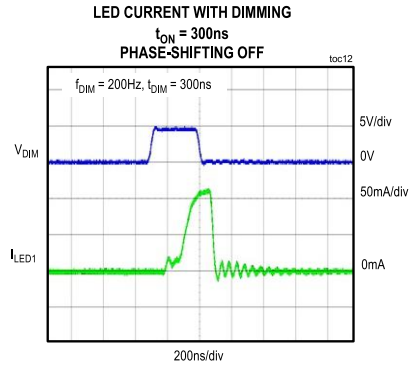
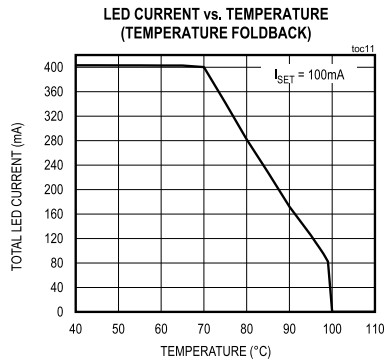
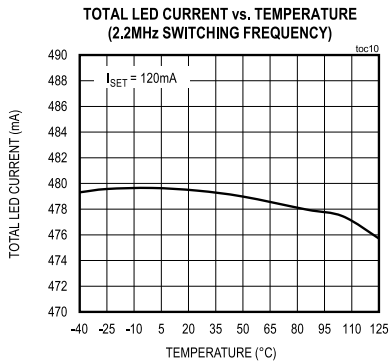

Pin Configuration

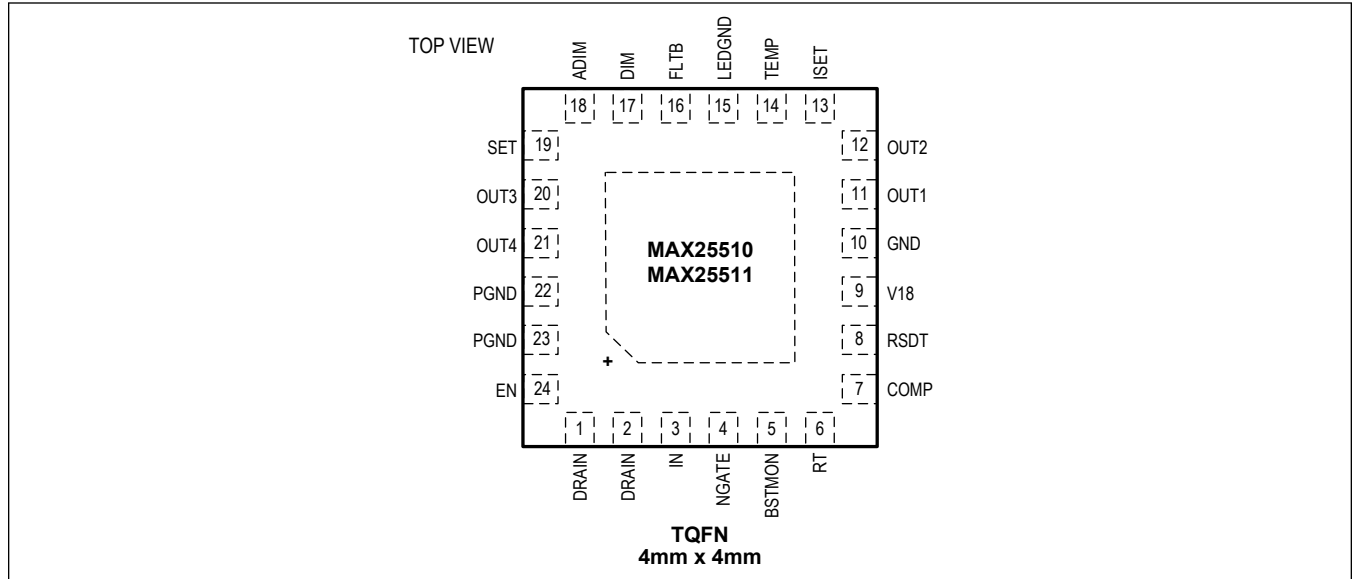

Pin Description

PIN	NAME	FUNCTION
1, 2	DRAIN	Drain Connection of Internal Switching Power nMOSFET. Connect to the external inductor and rectifier diode.
3	IN	Input Voltage. Connect to protected battery. Bypass IN with a minimum of 2.2µF in parallel with 0.1µF placed close to the pin.
4	NGATE	Gate Connection for External Series nMOSFET. Driven by the internal charge pump.
5	BSTMON	Boost Voltage Monitoring Input. Connect a resistor-divider from the boost converter output to GND with its midpoint connected to the BSTMON pin in order to set the maximum boost output voltage.
6	RT	Oscillator Timing Resistor Connection. Connect a timing resistor (RT) to GND to program the switching frequency. Apply an AC-coupled external clock at RT to synchronize the switching frequency with an external clock.
7	COMP	Switching Converter Compensation Input. Connect the compensation network from COMP to GND for current-mode control (see the Feedback Compensation section).
8	RSdT	LED Short-Detection Threshold-Adjust Input. Connect a resistive divider from V18 to RSdT and GND to program the LED short-detection threshold. Connect RSdT directly to V18 to disable LED short detection.
9	V18	Output of Internal 1.8V Regulator. Connect 1µF and 0.1µF capacitors from V18 to GND with the 0.1µF capacitor placed closest to the pin.
10	GND	Signal GND. GND is the current return path connection for the low-noise analog signals. Connect GND, LEDGND, and PGND at a single point.
11	OUT1	LED String Cathode Connection 1. OUT1 is the open-drain output of the linear current sink that controls the current through the LED string connected to OUT1. OUT1 sinks up to 120mA.
12	OUT2	LED String Cathode Connection 2. OUT2 is the open-drain output of the linear current sink that controls the current through the LED string connected to OUT2. OUT2 sinks up to 120mA. If OUT2 is unused, connect a 10kΩ resistor from OUT2 to LEDGND.
13	ISET	LED Current-Adjust Input. Connect a resistor (R _{ISET}) from ISET to GND to set the current through each LED string (I _{LED}), according to the formula I _{LED} = 1500/R _{ISET} . Place the resistor close to the pin to avoid parasitic capacitance.

Pin Description (continued)

PIN	NAME	FUNCTION
14	TEMP	Temperature Sensor Input. To implement LED current reduction at high temperatures connect an NTC temperature sensor to GND with resistors from the NTC to TEMP and to V18. If unused, connect TEMP to V18.
15	LEDGND	LED Ground. LEDGND is the return path connection for the linear current sinks. Connect GND, LEDGND, and PGND at a single point.
16	FLT B	Open-Drain Fault Output. FLT B asserts low when a fault is detected. Connect a pullup resistor from FLT B to a logic supply of 5V or lower.
17	DIM	Digital PWM Dimming Input. Apply a PWM signal to DIM for LED dimming control. Connect DIM to a logic supply of 5V or lower if dimming control is not used.
18	ADIM	Analog Dimming Input. Apply a PWM signal to ADIM to set the level of analog dimming. Connect ADIM to GND if analog dimming is not used.
19	SET	Option Setting Input. Connect a resistor to this pin to select phase/shifting on/off, spread spectrum on/off, and slow/fast soft/start timing. Total of eight options.
20	OUT3	LED String Cathode Connection 3. OUT3 is the open-drain output of the linear current sink that controls the current through the LED string connected to OUT3. OUT3 sinks up to 120mA. If OUT3 is unused, connect a 10kΩ resistor from OUT3 to LEDGND.
21	OUT4	LED String Cathode Connection 4. OUT4 is the open-drain output of the linear current sink that controls the current through the LED string connected to OUT4. OUT4 sinks up to 120mA. If OUT4 is unused, connect a 10kΩ resistor from OUT4 to LEDGND.
22, 23	PGND	Power Ground. PGND is the DRAIN current return path connection. Connect GND, LEDGND, and PGND at a single point.
24	EN	Enable Input. Connect EN to logic-high for normal operation. When EN is taken low, the device is disabled after a delay of t_{EN_OFF} . Do not leave the EN input open.

Functional Diagrams

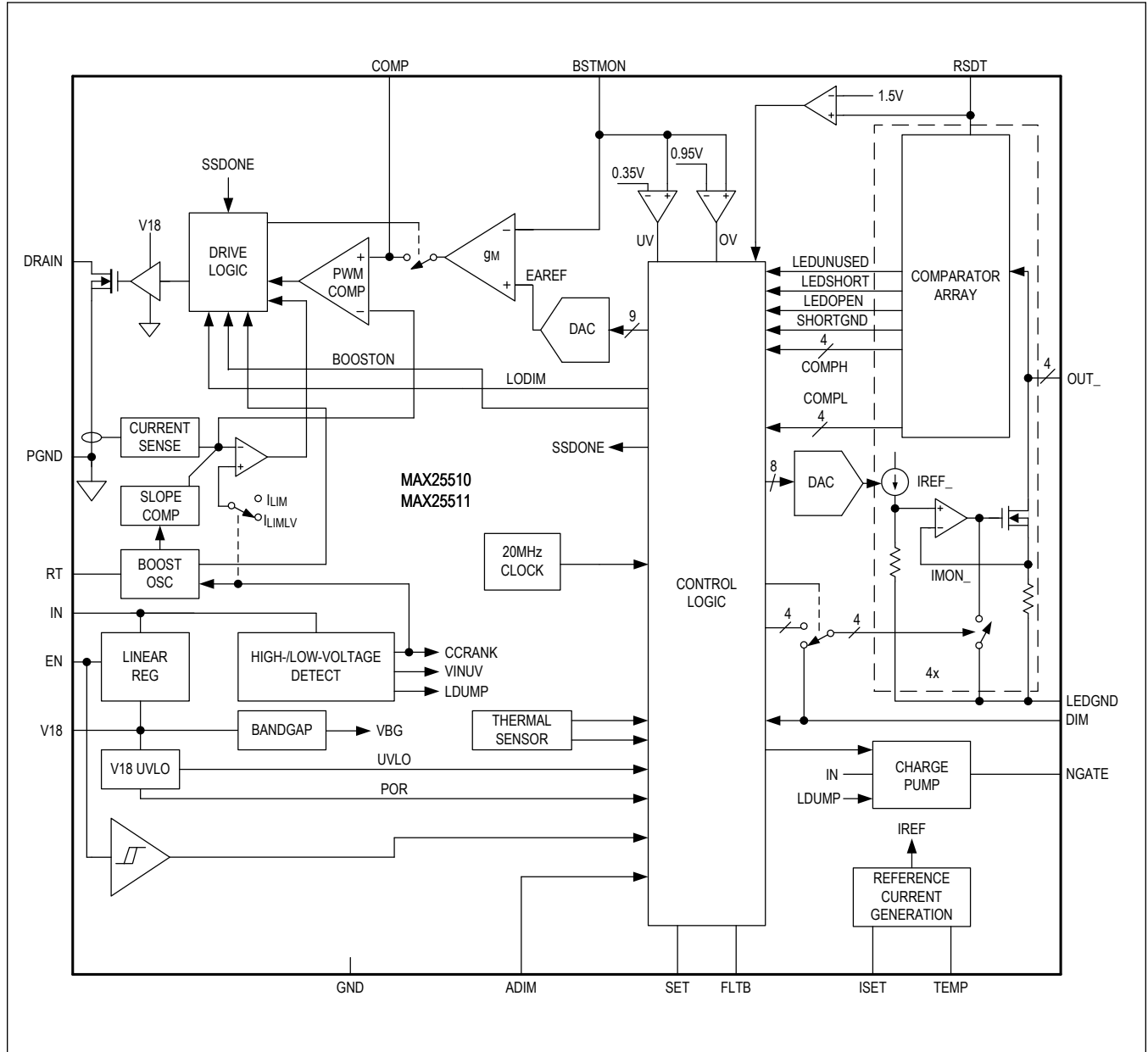

Detailed Description

The MAX25510/MAX25511 are 4-channel, backlight driver ICs with an integrated boost converter for automotive displays. The integrated current outputs can sink up to 120mA LED current each. The devices accept a wide 3V to 36V input voltage range. The ICs provide load-dump voltage protection up to 40V in automotive applications and incorporate three major blocks: a DC-DC converter with peak current-mode control to implement a boost or SEPIC-type switched-mode power supply, a 4-channel LED driver with up to 120mA constant-current sink capability per channel, and a logic control block.

The internal current-mode switching DC-DC converter supports boost or SEPIC topologies and operates in the 400kHz to 2.2MHz frequency range. Optional spread spectrum helps reduce EMI. An adaptive output-voltage-control scheme minimizes power dissipation in the LED current-sink paths.

The devices track the external pulse-width-modulation (PWM) dimming input on DIM. The minimum pulse width is 300ns. Phase-shifted dimming of the strings is selectable for lower EMI.

Comprehensive diagnostic and protection features are implemented.

Enable

The internal regulator is enabled when the EN pin is high. To shut down the device, drive EN low, and the current consumption is reduced to μ A levels.

The internal LDO regulator converts the input voltage at IN to a 1.8V output voltage at V18. The LDO regulator supplies current to the internal control circuitry and the gate driver.

Undervoltage Lockout

The IC features two undervoltage lockouts (UVLOs) that monitor the input voltage at IN and the output of the internal LDO regulator at V18. The device turns on when EN is taken high and the boost converter is enabled if both IN and V18 are higher than their respective UVLO thresholds.

After startup, the device can operate down to 3V as described in the paragraph [Low-Voltage Operation](#).

High-Voltage Operation

When the input voltage exceeds V_{LDUMP_TH} the NGATE output follows the IN voltage and the external nMOSFET operates as a source follower. During this time the power dissipation in the nMOSFET is higher than normal and is approximately $V_T \times I_{LED(TOTAL)}$ where V_T is the threshold voltage of the external nMOSFET.

Low-Voltage Operation

After the boost soft-start is completed, the MAX25510/MAX25511 can continue to operate with IN voltages as low as 3V.

At very low input voltages, the efficiency of the boost converter is reduced, and the input current can reach very high levels as a consequence. When the input voltage falls below V_{LVF} , the boost converter current limit is automatically increased to I_{LIMLV} , and the switching frequency is reduced if it is greater than 1.4MHz. In this mode, if the standard current limit (I_{LIM}) is exceeded on four consecutive cycles, a 100ms timer is started, which returns the current limit to I_{LIM} when it expires. When the input voltage returns above V_{LVR} , operation at the normal switching frequency is resumed.

The external boost converter components must be selected for worst-case operation. An alternative is to reduce the output power at low input voltages.

If the voltage at IN drops below the undervoltage lockout level (V_{INUVF}) at any time, the boost converter is disabled.

SET Pin Operation

The SET pin is used to enable/disable various features of the device by means of a resistor connected to GND. The resistance on the SET pin is read once at start-up, and the device features are then fixed until the next power-up/down cycle. [Table 1](#) sets out the possible settings:

Table 1. Set Pin Resistor Values

R_{SET} (Ω)	PHASE SHIFTING	START-UP	SPREAD SPECTRUM	AUTO FADE-IN/OUT
------------------------	----------------	----------	-----------------	------------------

Table 1. Set Pin Resistor Values (continued)

0	On	Fast	On	On
357	On	Fast	On	Off
590	On	Fast	Off	On
825	On	Fast	Off	Off
1130	On	Slow	On	On
1500	On	Slow	On	Off
2000	On	Slow	Off	On
2670	On	Slow	Off	Off
5900	Off	Fast	On	On
14300	Off	Fast	On	Off
23200	Off	Fast	Off	On
33200	Off	Fast	Off	Off
45300	Off	Slow	On	On
60400	Off	Slow	On	Off
80600	Off	Slow	Off	On
Connect RSET to V18	Off	Slow	Off	Off

Current-Mode DC-DC Controller

The IC has a constant-frequency, current-mode controller designed to drive the LEDs in a boost, SEPIC, or coupled-inductor buck-boost configuration. The IC features multiloop control to regulate the peak current in the inductor, as well as the voltage across the LED current sinks, to minimize power dissipation.

The switching frequency can be programmed over the 400kHz to 2.2MHz range using a resistor connected from RT to GND.

The internal MOSFET is turned on at the beginning of every switching cycle. The inductor current ramps up linearly until it is turned off at the peak current level set by the feedback loop. The peak inductor current is sensed internally and slope compensation is added.

The IC features leading-edge blanking to suppress the MOSFET switching noise. A PWM comparator compares the current-sense voltage plus the slope-compensation signal with the output of the transconductance error amplifier. The controller turns off the MOSFET when the total current-sense voltage exceeds the error amplifier's output voltage, which is also the voltage on the COMP pin. This process repeats every switching cycle to achieve peak current-mode control.

In addition to the peak current-mode-control loop, the IC has two other feedback loops for control. The converter output voltage is sensed through the BSTMON input, which goes to the inverting input of the error amplifier. The other feedback comes from the OUT_ current sinks. This loop controls the headroom of the current sinks to minimize total power dissipation while still ensuring accurate LED current matching. Each current sink has a window comparator with a low threshold of V_{OUTL} and a high threshold of V_{OUTH} . The outputs of these comparators control an up/down counter. The up/down counter is updated on every falling edge of the DIM input and drives an 8-bit DAC that sets the reference to the error amplifier. When dimming is set to 100%, the counter is updated at intervals of 10ms.

Output Undervoltage Protection

At the end of the boost converter soft-start, an undervoltage threshold is activated on the output of the DC-DC converter, which is set at 350mV. If the BSTMON pin is below this threshold after the soft-start period of the DC-DC converter, the converter is turned off and the NGATE output is turned off (thus turning off the external nMOSFET on the NGATE pin). The FLTB pin is asserted low whenever undervoltage protection is activated.

To restart the device, either the EN pin or power supply must be toggled.

9-Bit Digital-to-Analog Converter

The error amplifier's reference input is controlled with an 9-bit digital-to-analog converter (DAC). The DAC output is

ramped up slowly during startup to implement a soft-start function (see the [Startup Sequence](#) section). During normal operation, the DAC output range is limited to 0.482V to 0.996V. Because the DAC output is limited to no less than 0.482V during normal operation, the overvoltage threshold for the output should be set to a value less than twice the minimum LED forward voltage. The DAC LSB determines the minimum step-in output voltage according to the following equation:

$$V_{STEP_MIN} = V_{DAC_LSB} \times A_{OVP}$$

where:

V_{STEP_MIN} = Minimum output-voltage step

V_{DAC_LSB} = DAC least significant bit size (1.95mV)

A_{OVP} = BSTMON resistor-divider gain (1 + R6/R7)

LED Current Control

The full-scale sink current for the outputs (OUT1–OUT4) is set using the resistor on the ISET pin. Use the following equation to calculate the resistor value:

$$R_{ISET} = \frac{1500}{I_{LED}}$$

where I_{LED} is the individual OUT_ current.

If the R_{ISET} value is less than 11.9k Ω , the device may not operate.

When PWM dimming is used, the current in the OUT_ channels switches between zero and the full-scale sink current at the set duty cycle.

Dimming

Dimming can be performed using an external PWM signal applied to the DIM pin. The signal on the DIM pin is sampled with a 20MHz internal clock except when phase-shifting is disabled, in which case the DIM signal controls the OUT_ outputs directly. The device tracks frequency changes in the external PWM dimming input on DIM in phase-shift mode.

A single control signal can be used to enable the device and control dimming by connecting the DIM and EN pins together. In this case, the first pulse on DIM, which should be longer than t_{EN_ON} , turns the device on. If DIM stays low for longer than t_{EN_OFF} , the device is disabled.

Low-Dimming Mode

The IC's operation changes at very narrow dimming pulses to ensure a consistent dimming response of the LEDs. If the dimming on-time is lower than 50 μ s (typ), the device enters low-dimming mode. In this state, the converter switches continuously and LED short detection is disabled. When the DIM input is greater than 51 μ s (typ) the device goes back into normal operation, enabling the short-LED detection and switching the power FET only when the effective dimming signal is high.

Phase-Shift Dimming

When phase-shifting is enabled, the device automatically sets the phase shift between strings to 90°, 120°, or 180° depending on the number of strings enabled.

Automatic Fade-In/Fade-Out During Dimming

The device can be configured to perform a smooth change in brightness even when the DIM input duty-cycle is suddenly changed.

When using the fade function, it is important to maintain the DIM frequency constant when entering and leaving 100% duty-cycle. This is necessary in order to avoid erroneous frequency measurement, which could change the speed of the fade-in/out.

The step size in the dimming transition is 6.25%. The transition time depends on the initial and final dimming values according to:

$$t = \frac{1}{f_{\text{DIM}}} \times \frac{\ln(\text{DIM}_F) - \ln(\text{DIM}_i)}{0.0625}$$

where f_{DIM} is the dimming frequency, DIM_F is the final dimming setting, and DIM_i is the initial dimming setting. For this equation, DIM_F should be larger than DIM_i , but since the fading function is symmetrical, the values can be swapped if the final dimming ratio is lower than the initial one.

When transitioning to 100% dimming with fading enabled, do not change the input dimming from 100% until the complete fading transition to 100% has completed. Use the above equation to determine the transition time.

Disabling Individual Strings

To disable an unused LED string, connect the unused $\text{OUT}_\text{}$ to ground through a 10k Ω resistor. During startup, the device sources 60 μA (typ) current through the $\text{OUT}_\text{}$ pins and measures the corresponding voltage. For the string to be properly disabled, the $\text{OUT}_\text{}$ voltage should measure between 365mV and 1.15V during this check. 365mV is the maximum threshold for the $\text{OUT}_\text{}$ short-to-ground check, and 1.15V is the minimum unused string-detection threshold.

Note: When disabling unused strings, it is necessary to start by disabling the highest numbered current sinks first (e.g., if two strings need to be disabled, disable OUT_4 and OUT_3 . Do not disable any two strings at random).

ADIM Operation

A pulse train applied to ADIM causes the current value set by ISET to be reduced by a factor depending on the duty-cycle of the applied signal. The ADIM signal is converted internally to an 8-bit word. The curve in [Figure 1](#) demonstrates ADIM operation.

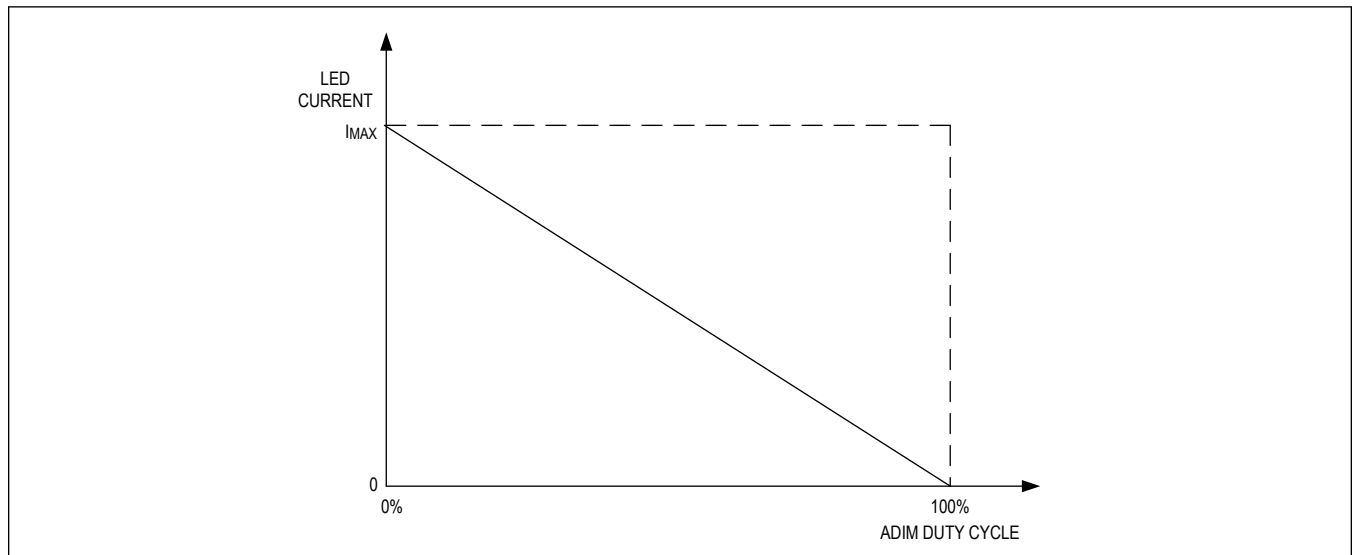

Figure 1. ADIM Operation Curve

If analog dimming is not used, it is important to connect the ADIM pin to GND so that the current setting is not affected by spurious pickup on the pin.

If the current set by the ADIM input is lower than 6.25% of the full-scale setting, the shorted-LED diagnostic is disabled.

Startup Sequence

When the EN pin is taken high (assuming the IN voltage is above its undervoltage-lockout value), the internal regulator is turned on. The device then checks the $\text{OUT}_\text{}$ channels for short-circuits to GND. If any of the $\text{OUT}_\text{}$ pins are detected as shorted to GND, the boost converter does not start (to avoid possible damage) and the FLTB pin is asserted low. The device also detects and disconnects any unused current-sink channels connected to GND by means of a 10k Ω resistor. The subsequent startup sequence occurs in three stages:

Stage 1

After the EN pin has been taken high and the initial checks are complete, the controller turns on the charge-pump for the external nMOSFET. The output current of the charge pump charges the gate of the external nMOSFET, thus turning it on. After a 2ms timeout expires, stage 2 of the startup begins.

Stage 2

After the NGATE turn-on interval, the converter starts switching and the output begins to ramp. The DAC reference to the error amplifier is stepped up 1 bit at a time until the voltage at BSTMON reaches 480mV (or 0.88V when fast soft-start is selected). This stage duration is fixed at approximately 50ms (typ) or 25ms when fast soft-start is selected. If the BSTMON voltage is greater than 480mV at the beginning of stage 2, the device transitions directly to stage 3. The BSTMON pin is sampled at the end of this stage—if its voltage is less than 350mV (typ), FLTBL is asserted low, the power converter is turned off, the internal boost MOSFET is turned off, and they all remain off until the input power or EN pin is toggled.

Stage 3

The third stage begins once stage 2 is complete and the DIM input goes high. During stage 3, the output of the converter is adjusted until the minimum OUT_ voltage falls between the V_{OUTH} and V_{OUTL} comparator limits. The output adjustment is again controlled by the DAC, which provides the reference for the error amplifier. The DAC output is updated on each rising edge of the DIM input pin. If the DIM input is at 100% duty cycle (DIM = high), the DAC output is updated once every 10ms.

The total soft-start time can be calculated using the following equation:

$$t_{SS} = 52ms + \frac{(V_{LED} + 0.715) - (0.6 \times A_{OVP})}{f_{DIM} \times 0.078 \times A_{OVP}}$$

where:

t_{SS} = Total soft-start time

52ms = Fixed stage 1 + stage 2 duration

V_{LED} = Total forward voltage of the LED strings

0.715V = Midpoint of the window comparator

f_{DIM} = Dimming frequency (use 100Hz for f_{DIM} when the input duty cycle is 100%)

0.078V = 4 times the 1.95mV LSB of the DAC

A_{OVP} = Gain of the BSTMON resistor-divider or $1 + R6/R7$

If fast soft-start is enabled, the soft-start is accelerated and the final value of the voltage on the BSTMON pin is 1.1V. The equation for the total soft-start time then becomes:

$$t_{SS} = 27ms + \frac{-(V_{LED} + 0.715) + (1.1 \times A_{OVP})}{f_{DIM} \times 0.078 \times A_{OVP}}$$

After the soft-start period, a fault is detected whenever the BSTMON pin falls below V_{BST_UVF} . When this occurs, the power converter is latched off and the NGATE output is discharged to ground, disconnecting the input voltage from the boost converter. The FLTBL pin is asserted low whenever the undervoltage protection is activated. Once the fault condition has been removed, cycling the EN pin or the supply is required to start up again.

Boost Startup

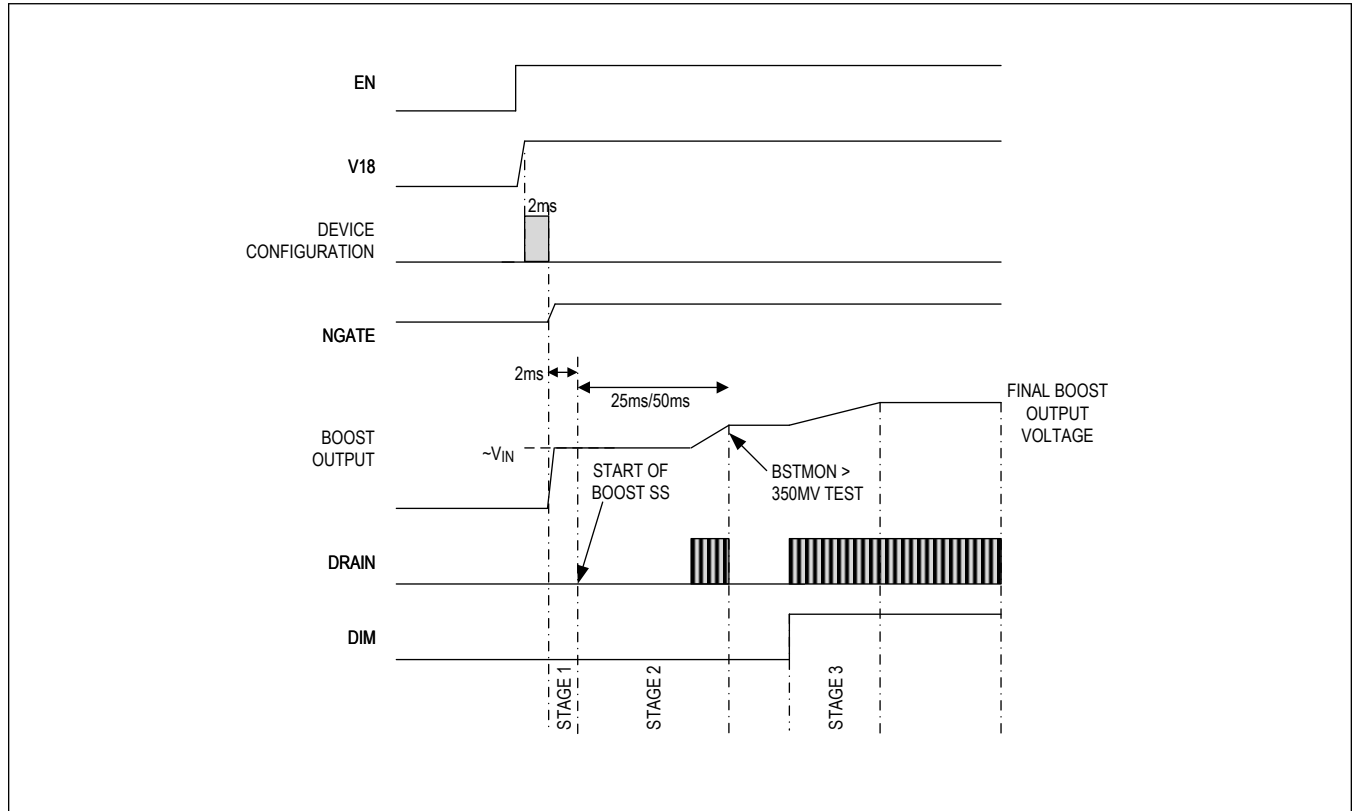

Figure 2. Boost Start-Up Waveforms

Oscillator Frequency/External Synchronization

The internal oscillator frequency is programmable between 400kHz and 2.2MHz using a timing resistor (R_{RT}) connected from the RT pin to GND. Use the following equation to calculate the value of R_{RT} for the desired switching frequency (f_{SW}):

$$R_{RT} = \frac{26.4 \times 10^6}{f_{SW}} - 0.32$$

where R_{RT} is in k Ω and f_{SW} is in Hz. For example, a 12k Ω resistor on pin RT sets a switching frequency of 2.14MHz.

If the value of the RT resistor is out of range or if the pin is shorted to GND, the boost converter will not start and the FLTB pin will go low.

Synchronize the oscillator with an external clock by AC-coupling the external clock to the RT input. The value of the capacitor used for AC-coupling is $C_{SYNC} = 10\text{pF}$, and the duty cycle of the external clock should be 50%. When synchronizing the converter, do not apply the synchronizing signal to the RT pin at start-up as this may cause the RT resistor value check to fail.

At low input voltages and when the switching frequency is above 1MHz, the switching frequency is automatically reduced by a factor of 30% to enable high-duty-cycle operation and maintain output voltage regulation. This also applies when the device is synchronized to an external frequency.

Spread Spectrum

The IC includes spread spectrum that reduces peak electromagnetic interference (EMI) at the switching frequency and its harmonics. Spread spectrum can be enabled and disabled at device start-up using the SET pin.

Spread spectrum uses a pseudorandom dithering technique where the switching frequency is varied between 94% and 106% of the programmed switching frequency set through the external resistor from RT to GND.

Spread spectrum is disabled if external synchronization is used.

Fault Protection

Fault protection in the IC includes cycle-by-cycle current limiting in the PWM controller, DC-DC converter output-undervoltage protection, output-overvoltage protection, open-LED detection, short-LED detection and protection, and overtemperature shutdown. Thermal shutdown and shorted-LED faults are automatically cleared when the fault is removed; however, FLTB stays low until the relevant fault register is read. It is cleared when the fault condition is removed during thermal shutdown and when shorted LEDs are identified. FLTB is latched low for an open-LED and can be reset by cycling power or by toggling the EN pin.

Open-LED Management and Overvoltage Protection

After the soft-start of the boost converter, the IC detects open-LED strings and disconnects any such strings from the internal minimum OUT_ voltage detector. This keeps the DC-DC converter output voltage within safe limits and maintains high efficiency.

During normal operation, the DC-DC converter output-regulation loop uses the minimum OUT_ voltage as the feedback input. If any LED string is open, the voltage at the opened OUT_ goes to V_{LEDGND}. The DC-DC converter output voltage then increases to the overvoltage-protection threshold set by the voltage-divider network connected between the converter output, the BSTMON input, and GND. The overvoltage-protection threshold at the DC-DC converter output is determined using the following equation:

$$V_{OUT_BSTMON} = 0.95 \times \left(1 + \frac{R6}{R7}\right)$$

where 0.95V (typ) is the overvoltage threshold on BSTMON (see the [Functional Diagram](#)). Select V_{OUT_BSTMON} according to the following formula:

$$1.1 \times (V_{LED_MAX} + 0.875) < V_{OUT_BSTMON} < 2 \times (V_{LED_MIN} + 0.55)$$

where,

V_{LED_MAX} = Maximum expected LED string voltage

V_{LED_MIN} = Minimum expected LED string voltage

Select R6 and R7 so that the voltage at OUT_ does not exceed the absolute maximum rating. As soon as the DC-DC converter output reaches the overvoltage-protection threshold, the internal MOSFET is switched off.

The overvoltage threshold should be set to less than twice the minimum LED voltage to ensure proper operation and so that the BSTMON minimum regulation point of 0.48V (typ) is not breached. When an open-LED overvoltage condition occurs, FLTB is latched low. Any current-sink output with V_{OUT_} < V_{OOL} is permanently disconnected from the minimum voltage detector.

Shorted-LED Detection

The IC checks for shorted LEDs after the current in any channel is turned on. A shorted-LED is detected at OUT_ if the following condition is met:

$$V_{OUT_} > V_{SLDET}$$

where V_{SLDET} = 12x the voltage set on the RSdT pin.

If a short is detected on any of the strings, the affected LED strings are disconnected and the FLTB output flag asserts low until the device detects that the shorts are removed. Disable short-LED detection by connecting RSdT to V18.

Shorted-LED detection is disabled in low-dimming mode and when the current set by the ADIM input is lower than 6.25% of the ISET setting.

When the DIM input is connected continuously high, the OUT_ pins are periodically scanned to detect shorted LEDs. The scan frequency is 100Hz.

OUT_ Short-to-GND Detection

During device start-up, the OUT_ pins are checked for short circuits to ground by sourcing a current I_{CHKLED} into the OUT_ pin and measuring the resultant voltage. If the voltage is below V_{TH_SGND} , the OUT_ is considered shorted to ground and the boost converter does not start.

Thermal Shutdown

The IC includes thermal protection that operates at a temperature of T_{SHDN} . When the thermal-shutdown temperature is reached, the device is immediately disabled so it can cool. When the junction temperature falls by $17^{\circ}C$, the device is re-enabled and the boost converter performs a soft-start. When a thermal shutdown occurs, the FLTB pin goes low.

Temperature Foldback

When an NTC temperature sensor is connected between GND and a resistor (RT1) connected to the V18 supply, with a further resistor (RT2) connected from the junction of the NTC and RT1 to the TEMP pin, temperature foldback is implemented. When the temperature reaches the temperature T1 (set by RT1), the current in the LEDs is reduced according to the linear scheme shown in Figure 3. The slope of the current reduction is set nominally by RT2. The MAX25510/MAX25511 is specifically designed to be used with the NTCLE100E3 or a similar NTC device. Table 2 illustrates some examples of values of RT1 and RT2 to obtain certain values of T1 and TDELTA.

Table 2. Temperature Foldback Sample Resistor Values

RT1	RT2	T1	TDELTA
20kΩ	1.9kΩ	+60°C	+40°C
14kΩ	2kΩ	+70°C	+30°C
10kΩ	1.5kΩ	+80°C	+25°C

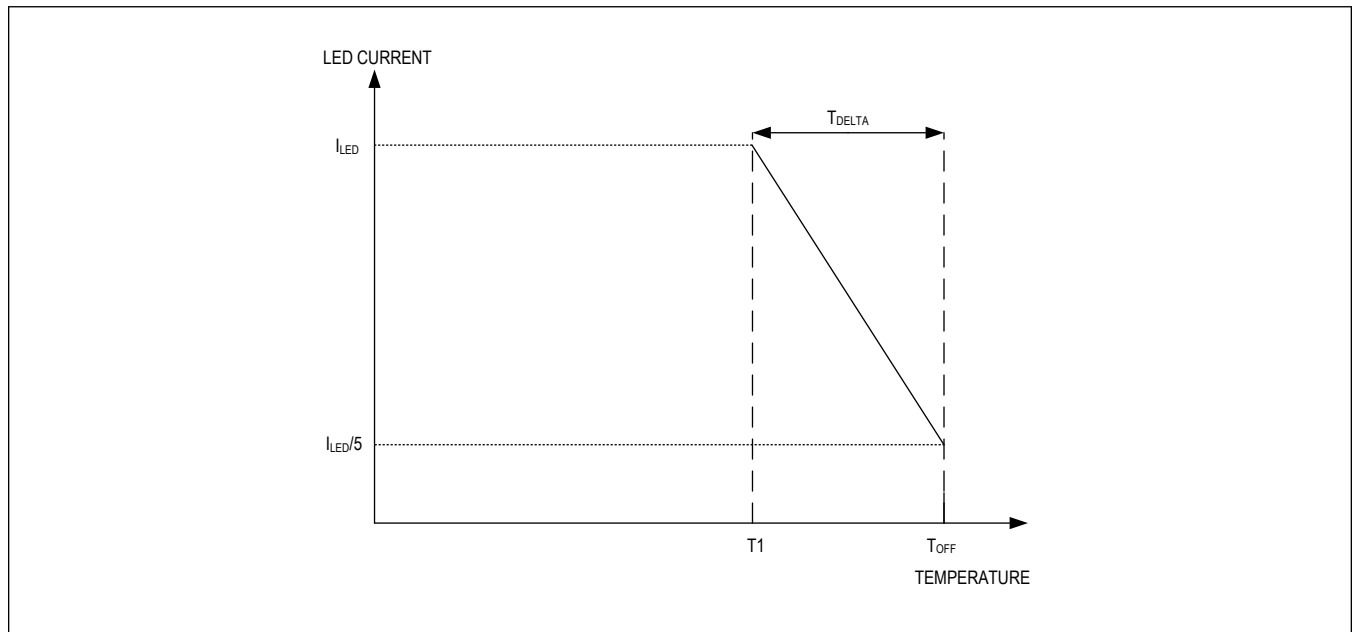

Figure 3. Temperature Foldback Curve

Above Temperature T_{OFF}

When the temperature reaches T_{OFF} , the LED current is turned off and the FLTB pin asserts low.

Applications Information

DC-DC Converter

The MAX25510/MAX25511 DC-DC converters offer the capability to work with two different converter topologies that have the ground-referenced outputs necessary to use the constant-current sink drivers. If the LED string forward voltage is always greater than the input supply voltage range, use the boost-converter topology. If the LED string forward voltage falls within the supply voltage range, use the SEPIC topology.

The boost-converter topology provides the highest efficiency of these topologies. The SEPIC configuration requires either two inductors or a coupled inductor and a coupling capacitor.

Power-Circuit Design

First, select a converter topology based on the factors listed above. Determine the required input supply voltage range, the maximum voltage needed to drive the LED strings including the minimum 0.875V across the constant LED current sink (V_{LED}), and the total output current needed to drive the LED strings (I_{LED}), as shown in the following equation:

$$I_{LED} = I_{STRING} \times N_{STRING}$$

where I_{STRING} is the current per string, and N_{STRING} is the number of strings used.

Next, calculate the maximum duty cycle (D_{MAX}) using one of the following equations, depending on the configuration:

Boost Configuration:

$$D_{MAX} = \frac{(V_{LED} + V_{D1} - V_{IN_MIN})}{(V_{LED} + V_{D1} - V_{DS} - 0.3)}$$

SEPIC Configuration:

$$D_{MAX} = \frac{V_{LED} + V_{D1}}{(V_{IN_MIN} - V_{DS} - 0.3 + V_{LED} + V_{D1})}$$

where,

V_{D1} = Forward drop of the rectifier diode in volts (approximately 0.6V)

V_{IN_MIN} = Minimum input supply voltage

V_{DS} = Drain-to-source voltage of the internal MOSFET when it is on, given by $I_{LAVG} \times R_{DS(ON)}$ where $R_{DS(ON)} = 125m\Omega$

Select the switching frequency (f_{SW}) depending on space, noise, and efficiency constraints.

Boost Configuration

In the converter configurations, the average inductor current varies with the input voltage; the maximum average current occurs at the lowest input voltage. For the boost converter, the average inductor current is equal to the input current. Select the maximum peak-to-peak ripple on the inductor current (ΔI_L). The recommended maximum peak-to-peak ripple is 60% of the average inductor current, but lower and higher ripple values are also acceptable.

Use the following equations to calculate the maximum average inductor current (I_{LAVG}) and peak inductor current (I_{LP}) in amps (A).

$$I_{LAVG} = \frac{I_{LED}}{(1 - D_{MAX})}$$

Allowing the peak-to-peak inductor ripple (ΔI_L) to be $\pm 30\%$ of the average inductor current:

$$\Delta I_L = I_{LAVG} \times 0.3 \times 2$$

and:

$$I_{LP} = I_{LAVG} + \frac{\Delta I_L}{2}$$

Calculate the minimum inductance value (L_{MIN}) in henries (H) with the inductor current ripple set to the maximum value:

$$L_{MIN} = \frac{(V_{IN_MIN} - V_{DS} - 0.3) \times D_{MAX}}{f_{SW} \times \Delta IL}$$

where V_{DS} is $IL_{AVG} \times 0.125$. Choose an inductor with a minimum inductance greater than the calculated L_{MIN} and current rating greater than IL_P . The recommended saturation current limit of the selected inductor is 10% higher than the inductor peak current.

SEPIC Configuration

Power-circuit design for the SEPIC configuration is very similar to a conventional design with the output voltage referenced to the input supply voltage. For SEPIC, the output is referenced to ground and the inductor is split into two parts. One of the inductors (L_2) takes LED current as the average current, and the other (L_1) takes input current as the average current.

Use the following equations to calculate the average inductor currents (IL_{1AVG} , IL_{2AVG}) and peak inductor currents (IL_{1P} , IL_{2P}) in A.

$$IL_{1AVG} = \frac{I_{LED} \times D_{MAX} \times 1.1}{1 - D_{MAX}}$$

The factor 1.1 provides a margin of 10% to account for the converter losses.

$$IL_{2AVG} = I_{LED}$$

Assuming the peak-to-peak inductor ripple ΔIL is $\pm 30\%$ of the average inductor current:

$$\Delta IL_1 = IL_{1AVG} \times 0.3 \times 2$$

and:

$$IL_{1P} = IL_{1AVG} + \frac{\Delta IL_1}{2}$$

and:

$$\Delta IL_2 = IL_{2AVG} \times 0.3 \times 2$$

and:

$$IL_{2P} = IL_{2AVG} + \frac{\Delta IL_2}{2}$$

Calculate the minimum inductance values (L_{1MIN} and L_{2MIN}) in H with the inductor current ripple set to the values previously calculated.

$$L_{1MIN} = \frac{(V_{IN_MIN} - V_{DS} - 0.3) \times D_{MAX}}{f_{SW} \times \Delta IL_1}$$

$$L_{2MIN} = \frac{(V_{IN_MIN} - V_{DS} - 0.3) \times D_{MAX}}{f_{SW} \times \Delta IL_2}$$

Choose inductors with a minimum inductance greater than the calculated L_{1MIN} and L_{2MIN} and current ratings of greater than IL_{1P} and IL_{2P} , respectively. The recommended saturation current limit of the selected inductor is 10% higher than the inductor peak current.

To simplify further calculations, consider a single inductor equivalent to L_1 and L_2 connected in parallel. The combined inductance value and current is calculated as follows:

$$L = \frac{L_1 \times L_2}{L_1 + L_2}$$

and:

$$IL_{AVG} = IL_{1AVG} + IL_{2AVG}$$

where IL_{AVG} represents the total average current through both of the inductors in the SEPIC configuration. Use these

values in the calculations in the following sections.

Select coupling-capacitor C_S so that its peak-to-peak ripple is less than 2% of the minimum input supply voltage. This ensures that the second-order effects created by the series-resonant circuit comprising L1, C_S , and L2 do not affect the normal operation of the converter. Use the following equation to calculate the minimum value of C_S :

$$C_S = \frac{I_{LED} \times D_{MAX}}{V_{IN_MIN} \times 0.02 \times f_{SW}}$$

where,

C_S = Minimum value of the coupling capacitor in farads (F)

0.02 = 2% ripple factor

Output Capacitor Selection

The output capacitor supplies the load current when the main switch is on. The function of the output capacitor is to reduce the converter output ripple to acceptable levels. The entire output-voltage ripple appears across the constant-current sink outputs because the LED-string voltages are stable due to the constant current. For the MAX25510/MAX25511, limit peak-to-peak output-voltage ripple to 250mV to get stable output current.

The equivalent series resistance (ESR), equivalent series inductance (ESL), and bulk capacitance of the output capacitor contribute to the output ripple. In most applications, using low-ESR ceramic capacitors can dramatically reduce the output ESR and ESL effects. To reduce this, connect multiple ceramic capacitors in parallel to achieve the required bulk capacitance. To minimize audible noise during PWM dimming, the amount of ceramic capacitors on the output is usually minimized. In this case, an additional electrolytic or aluminum organic polymer capacitor can provide most of the bulk capacitance.

Rectifier Diode Selection

Using a Schottky rectifier diode produces less forward drop and puts the least burden on the MOSFET during reverse recovery. Select a diode with low reverse-recovery losses to reduce the MOSFET switching losses and avoid increased EMI. The voltage rating of the diode should be 20% higher than the maximum boost-converter output voltage and its current rating greater than the following:

$$I_{L_AVG} \times (1 - D_{MAX}) \times 1.2$$

Feedback Compensation

During normal operation, the feedback control loop regulates the minimum $V_{OUT_}$ voltage to fall within the window comparator limits of V_{OUTL} and V_{OUTH} when LED string currents are enabled during PWM dimming. When LED currents are off during PWM dimming, the control loop turns off the converter (when $BSTFORCE = 0$) and stores the previous boost output-voltage value for use during the next on cycle.

The switching converter small-signal-transfer function has a right-half plane (RHP) zero in the boost configuration if the inductor current is in continuous-conduction mode. The RHP zero adds a 20dB/decade gain together with a 90° phase lag, which is difficult to compensate.

Worst-Case RHP Zero Frequency (f_{ZRHP}):

$$f_{ZRHP} = \frac{V_{LED} \times (1 - D_{MAX})^2}{2 \times \pi \times L \times I_{LED}}$$

SEPIC Configuration:

$$f_{ZRHP} = \frac{V_{LED} \times (1 - D_{MAX})^2}{2 \times \pi \times L \times I_{LED} \times D_{MAX}}$$

The standard way to avoid this zero is to roll off the loop gain to 0dB at a frequency of less than 1/5 of the RHP zero frequency with a -20dB/decade slope.

The switching converter small-signal transfer function also has an output pole. The effective output impedance, together

with the output filter capacitance, determines the output pole frequency (f_{P1}) that is calculated for the boost configuration, as shown in the following equation:

$$f_{P1} = \frac{I_{LED}}{\pi \times V_{LED} \times C_{OUT}}$$

SEPIC Configuration:

$$f_{P1} = \frac{I_{LED} \times D_{MAX}}{\pi \times V_{LED} \times C_{OUT}}$$

Compensation components R_{COMP} and C_{COMP} perform two functions. C_{COMP} introduces a low-frequency pole that presents a -20dB/decade slope to the loop gain. R_{COMP} flattens the gain of the error amplifier for frequencies above the zero formed by R_{COMP} and C_{COMP} . For compensation, this zero is placed at f_{P1} to provide a -20dB/decade slope for frequencies above f_{P1} to the combined modulator and compensator response.

The value of R_{COMP} needed to fix the total loop gain at f_{P1} so the total loop gain crosses 0dB with -20dB/decade slope at 1/5 the RHP zero frequency is calculated for the boost configuration as follows:

$$R_{COMP} = \frac{f_{ZRHP} \times R_{CS} \times I_{LED} \times A_{OVP}}{5 \times f_{P1} \times GM_{COMP} \times V_{LED} \times (1 - D_{MAX})}$$

SEPIC Configuration:

$$R_{COMP} = \frac{f_{ZRHP} \times R_{CS} \times I_{LED} \times A_{OVP} \times D_{MAX}}{5 \times f_{P1} \times GM_{COMP} \times V_{LED} \times (1 - D_{MAX})}$$

where,

R_{COMP} = Compensation resistor in Ω

A_{OVP} = BSTMON resistor-divider gain (a value $\gg 1$)

R_{CS} = Current-sense resistor of value 0.066 Ω

GM_{COMP} = Transconductance of the error amplifier (600 μ S)

The value of C_{COMP} is calculated as follows:

$$C_{COMP} = \frac{1}{2 \times \pi \times f_{Z1} \times R_{COMP}}$$

where f_{Z1} is the compensation zero placed at 1/5 the crossover frequency; in turn, it is set at 1/5 the f_{ZRHP} . If the output capacitors do not have low ESR, the ESR zero frequency can fall below the 0dB crossover frequency. An additional pole may be required to cancel out this zero placed at the same frequency. This can be added by connecting a capacitor from the COMP pin directly to GND with a value shown as follows:

$$C_{PAR} = GM_{COMP} \times R_{ESR} \times C_{OUT}$$

where,

R_{ESR} = Capacitor ESR value

C_{OUT} = Output-capacitor value

External Disconnect MOSFET Selection

An external nMOSFET can be used to disconnect the boost output from the battery in the event of an output overload or short condition. There is no need for the nMOSFET in the case of the SEPIC or buck-boost, since this protection is not necessary. Leave the NGATE pin disconnected when an external nMOSFET is not used. If it is necessary to have output-short protection for the boost even at power-up, then the current through the nMOSFET must be sensed (refer to the MAX25510/MAX25511 evaluation kit (EV kit) for a reference circuit). Once the current-sense voltage exceeds a certain threshold, it should limit the input current to the programmed threshold. This threshold should be set at a sufficiently high level so it never trips at startup or under normal operating conditions. Check the safe operating area (SOA) of the nMOSFET to confirm that the current-limit-trip threshold and voltage on the MOSFET do not exceed the limits of the SOA curve of the nMOSFET at the highest operating temperature.

Ensure that the maximum value of the nMOSFET gate threshold voltage is lower than 4V for reliable operation.

V_{OUT} to OUT_ Bleed Resistors

The OUT_ pins have a leakage specification of 4μA (max) in cases where all OUT_ pins are shorted to 36V (see I_{OUTLEAK} in the [Electrical Characteristics](#) table). This leakage current is dependent on the OUT_ voltage and is higher at higher voltages. Therefore, in cases where large numbers of LEDs are connected in series, a 100kΩ (or larger) bleed resistor can be placed in parallel with the LED string to prevent the OUT_ leakage current from turning on the LEDs dimly, even when the DIM signal is low (see resistors R8–R11 in the [Typical Application Circuit](#)).

Thermal Considerations

The on-chip power dissipation of the MAX25510/MAX25511 comprises four main factors:

1. Current-sink power loss = $0.875V \times I_{LED}$
2. Device operating current power loss = $V_{IN} \times 1.3mA$
3. Power due to R_{DS(ON)} of the internal MOSFET = $DC \times I_{LAVG}^2 \times 0.125$
4. Power due to switching losses in the internal MOSFET = $0.5 \times V_{LED} \times I_{LED} \times t_{R/F} \times f_{SW}$ where $t_{R/F}$ is the rise/fall time of the boost converter switching node approximated to 6ns.

Calculate the total power dissipation by adding the values calculated above. The junction temperature at the maximum ambient temperature can then be calculated as follows:

$$T_J = T_A + P_{TOT} \times \theta_{JA}$$

where,

T_A = Ambient temperature

θ_{JA} = Junction-to-ambient thermal resistance of the package (36°C/W on a four-layer board). Ensure that the junction temperature does not exceed +150°C.

As an example, consider an application with a minimum operating voltage of 9V, a total output current of 400mA at 28.7V and an average 1.5A inductor current. With a switching frequency of 400kHz, the total power dissipation is calculated in the following equation:

$$P_{TOT} = (0.875 \times 0.4) + (9 \times 0.0013) + \left(\frac{28.7}{28.7+9} \times 1.5^2 \times 0.125\right) + (0.5 \times 28.7 \times 0.4 \times 6E-9 \times 400000) = 0.59W$$

The maximum junction temperature at an ambient temperature of +85°C is shown in the following equation:

$$T_J = 85 + 0.59 \times 36 = +106^\circ C$$

PCB Layout Considerations

LED driver circuits based on the MAX25510/MAX25511 use a high-frequency switching converter to generate the voltage for LED strings. Take proper care while laying out the circuit to ensure correct circuit operation. The switching-converter part of the circuit has nodes with fast voltage changes that can lead to undesirable effects on the sensitive parts of the circuit. Use the following guidelines to reduce noise as much as possible:

- Connect the bypass capacitors on V18 as close as possible to the device. Make the connections directly to the device's V18 and GND pins. Connect the GND pin of the device to the analog ground plane and to the exposed pad of the device. Place the analog ground plane on an inner layer.
- Place a power ground plane for the switching-converter power circuit under the power components (input filter capacitor, output filter capacitor, inductor, and rectifier diode). Connect the PGND pins to the power ground plane and to the exposed pad of the device. Connect all other ground connections to the power ground plane using vias close to the terminals.
- There are two loops in the power circuit that carry high-frequency switching currents. One loop exists when the internal MOSFET is on (from the input filter capacitor positive terminal, through the inductor and internal MOSFET, to the input capacitor negative terminal). The other loop exists when the MOSFET is off (from the input capacitor positive terminal, through the inductor, the rectifier diode, output filter capacitor, to the input capacitor negative terminal). Analyze these two loops in order to make the loop areas as small as possible. Wherever possible, have a return path on the power ground plane for the switching currents on the top-layer copper traces or through power components. This reduces the loop area considerably and provides a low-inductance path for the switching currents. Reducing the loop area also

- decreases radiation during switching.
- Connect the power ground plane for the constant-current LED driver part of the circuit to the LEDGND pin. Also connect the LEDGND pin to the device's exposed pad.
- Add a small bypass capacitor (22pF to 47pF) to the BSTMON input. Place the capacitor as close as possible to the pin to suppress high-frequency noise.
- Boost output voltage for the LED strings must be taken directly from the output capacitors and not from the boost diode anode.
- Input and output capacitors need good grounding with wide traces and multiple vias to the ground plane.
- To enhance device power dissipation, add multiple vias under the device's exposed pad connected to an area of copper on the backside of the PCB. This is important for maintaining device efficiency and reducing junction temperature during operation.

Refer to the EV kit for a reference layout.

Typical Application Circuits

Boost Application

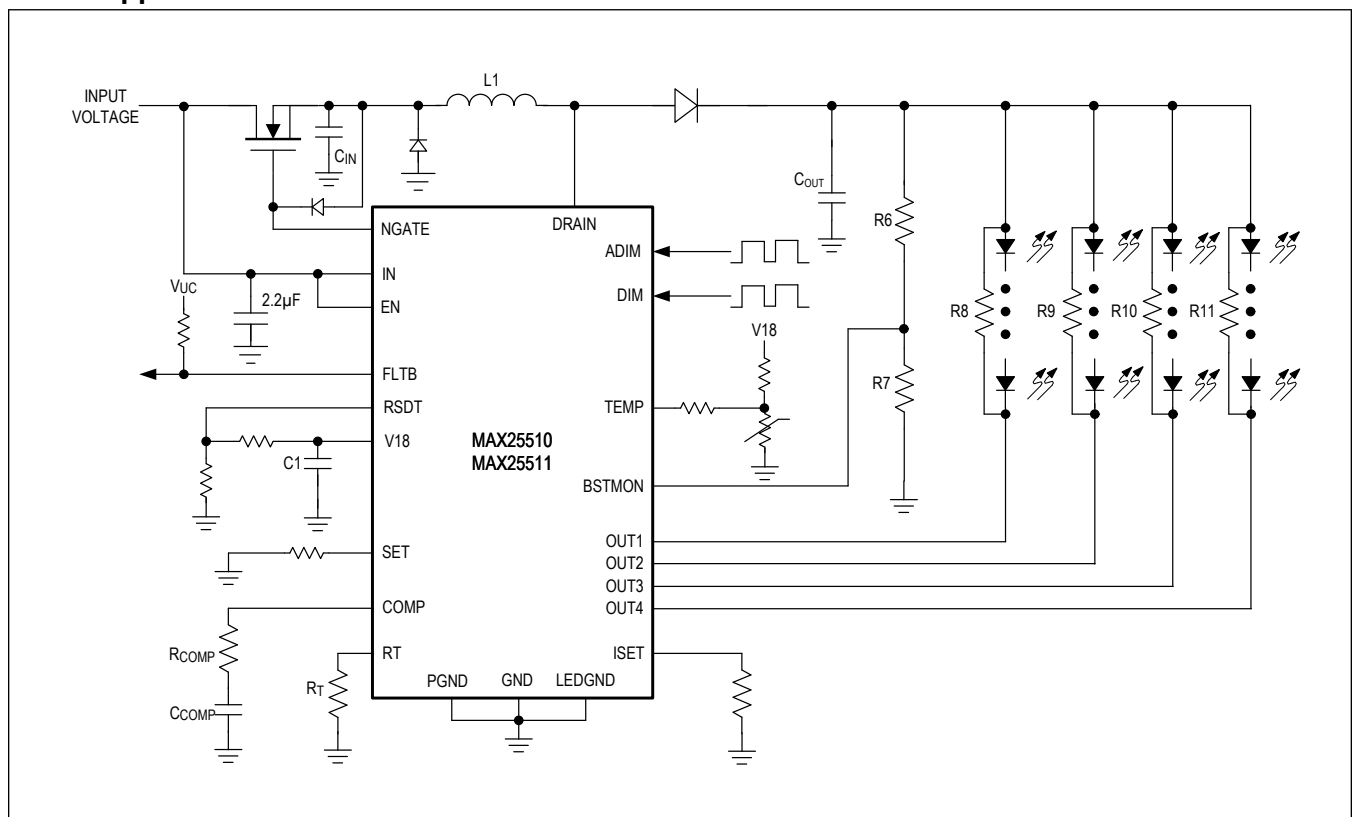

Ordering Information

PART NUMBER	TEMPERATURE RANGE	PIN-PACKAGE	OPTION
MAX25510ATGA/V+	-40°C to +125°C	24 TQFN-EP*	Lower boost current limit
MAX25510ATGB/V+**	-40°C to +125°C	24 TQFN-EP*	PWM FLTB output, lower boost current limit
MAX25511ATGA/V+	-40°C to +125°C	24 TQFN-EP*	Higher boost current limit
MAX25511ATGB/V+**	-40°C to +125°C	24 TQFN-EP*	PWM FLTB output, higher boost current limit

V Denotes an automotive-qualified part.

+ Denotes a lead(Pb)-free/RoHS-compliant package.

T = Tape and reel.

**EP* = Exposed pad.

Y = Side-wettable (SW) package.

**** Future product—contact factory for availability.

Revision History

REVISION NUMBER	REVISION DATE	DESCRIPTION	PAGES CHANGED
0	8/21	Initial release	—

For pricing, delivery, and ordering information, please visit Maxim Integrated's online storefront at <https://www.maximintegrated.com/en/storefront/storefront.html>.

Maxim Integrated cannot assume responsibility for use of any circuitry other than circuitry entirely embodied in a Maxim Integrated product. No circuit patent licenses are implied. Maxim Integrated reserves the right to change the circuitry and specifications without notice at any time. The parametric values (min and max limits) shown in the Electrical Characteristics table are guaranteed. Other parametric values quoted in this data sheet are provided for guidance.