



ENGLISH

Datasheet

Stock No: 401692

## RS PRO Panel Mount Toggle Switch



**Feature:**

**ON-OFF-ON**

**10.41 high**

**8.89 high, keyway (thd std)**

**PC thru-hole**

**Silver**

**EPOXY (std)**

**RoHS & Lead Free**

**Code symbol:**

**1MD3**

**T1**

**B1**

**M2**

**Q**

**E**

**S**

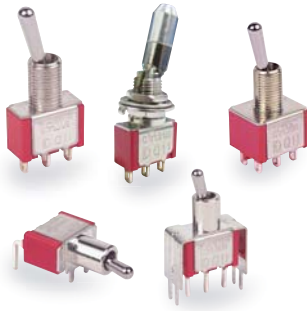

## SPECIFICATIONS

**CONTACT RATING:** Dependent upon contact material, see page 11.

**MECHANICAL LIFE:** 40,000 make-and-break cycles.

**CONTACT RESISTANCE:** 10mΩ max. (initial value) @ 2-4VDC  
100mA for both silver and gold plated contacts.

**INSULATION RESISTANCE:** 1,000 MΩ min./1000VDC

**DIELECTRIC STRENGTH:** 1,000 Vrms min. @ sea level. (initial value)

**OPERATING TEMPERATURE:** -40°C to 85°C.

## MATERIALS

**CASE:** Diallyl phthalate (DAP) (UL94v-0).

**ACTUATOR:** Brass, chrome plated.

**BUSHING:** Brass, nickel plated.

**HOUSING:** Stainless steel.

**SWITCH SUPPORT:** Brass, tin plated.

**CONTACT / TERMINALS:** Copper with silver or gold plated.

(See page 11)

MODEL NO.	ACTUATOR	BUSHING	TERMINAL TYPE	TERMINAL PLATING	SEAL	RoHS SOLDERING
<b>SP</b>				<b>Q</b> Silver <b>R</b> Gold <b>C</b> Gold over silver	<b>E</b> EPOXY (std) <b>N</b> NO EPOXY	<b>S</b> RoHS & Lead Free
1MS1 ON-NONE-ON	T1 10.41 high					
1MS2 ON-NONE-(ON)	T2 5.08 high					
1MS3 ON-OFF-ON	T3 13.97 high					
1MS4 (ON)-OFF-(ON)	T4 16.26 high					
1MS5 ON-OFF-(ON)	T5 21.34 high					
	T9□ 21.3 high, Plastic		<b>B1</b> 8.89 high, keyway (thd std)		<b>M1</b> Solder lug	
	T7 12.37 high **		<b>B2</b> 8.89 high, keyway (non-thd)		<b>M2</b> PC thru-hole	
<b>DP</b>	T8 17.56 high **		<b>B3</b> 7.10 high, keyway (thd)		<b>M3</b> Quick connect	
1MD1 ON-NONE-ON	T88 17.5 high ***		<b>B4</b> 7.10 high, keyway (non-thd)		<b>M51</b> 18.70 high, wire wrap	
1MD2 ON-NONE-(ON)			<b>B7</b> 8.89 high, flat (thd std)		<b>M52</b> 24.20 high, wire wrap	
1MD3 ON-OFF-ON	<u>Anti-rotation</u>		<b>B8</b> 8.89 high, keyway (metric thd)		<b>M53</b> 10.55 high, wire wrap	
1MD4 (ON)-OFF-(ON)	T6 12.30 high		<b>B11</b> 7.55 high, keyway (thd std) ****		<b>M54</b> 26.97 high, wire wrap	
1MD5 ON-OFF-(ON)	T61 21.0 high		<b>B12</b> 7.55 high, keyway (non-thd) ****		<b>M6</b> Right angle, PC thru-hole	
1MD6 ON-ON-ON	T62 13.49 high, With cap		<b>B13</b> 11.38 high, keyway (15/32 bushing)		<b>M6N</b> Right angle, Snap-in, PC thru-hole	
1MD7 (ON)-ON-(ON) ▲	T63 6.35 high		<b>B15</b> 7.55 high, flat (thd std) ****		<b>M7</b> Vertical right angle, PC thru-hole	
1MD8 ON-ON-(ON) ▲	<u>Locking lever</u>		<b>B16</b> 7.55 high, flat (non-thd) ****			
	TL1 16.00 high		<b>B17</b> 3.50 high, keyway, (thd)		<u>V-bracket</u>	
<b>3P</b>	TL2 16.26 high		<b>B18</b> 11.38 high, keyway (15/32 bushing)		<b>VS2</b> 11.68 high	
1M31 ON-NONE-ON	TL3 17.28 high		<b>B20</b> 11.38 high, keyway (15/32 bushing)		<b>V2N</b> 11.68 high, Snap-in.	
1M32 ON-NONE-(ON)					<b>VS3</b> 16.00 high	
1M33 ON-OFF-ON			<u>High torque</u>		<b>VS4</b> 11.68 high	
1M34 (ON)-OFF-(ON)			<b>B5</b> 7.52 high, flat		<b>VS5</b> 16.00 high	
1M35 ON-OFF-(ON)			<b>B6</b> 8.00 high, keyway			
<b>4P</b>			<u>Locking</u>			
1M41 ON-NONE-ON			<b>B25</b> 8.00 high, keyway, (thd) *			
1M42 ON-NONE-(ON)			<b>B26</b> 8.00 high, keyway, (non-thd) *			
1M43 ON-OFF-ON			<u>Splash proof</u>			
1M44 (ON)-OFF-(ON)			<b>B9</b> 7.52 high, flat, (thd)			
1M45 ON-OFF-(ON)			<b>B14</b> 11.90 high, flat, (15/32 bushing)			
1M46 ON-ON-ON			<b>B52</b> 11.70 high, flat, (15/32 bushing) ***			
1M47 (ON)-ON-(ON) ▲						
1M48 4P ON-ON-(ON) ▲						

▲ Please confirm the availability before order.

\* Only available for Locking lever.  
\*\* Only available for 15/32 bushing.  
\*\*\* T88 actuators are only available with B52 bushing  
\*\*\*\* Only available for Anti-rotation lever.

EXAMPLE: 1MS1T1B1M1QES

### SWITCH FUNCTION

NO. POLES	UL/CSA MODEL NO.	MODEL NO.	SWITCH FUNCTION			CONNECTED TERMINALS / SCHEMATIC		
			POS.1	POS.2	POS.3	POS.1	POS.2	POS.3
SP	Q1111	1MS1	ON	NONE	ON		N/A	2-1
	Q1112	1MS2	ON	NONE	(ON)			
	Q1113	1MS3	ON	OFF	ON			
	Q1114	1MS4	(ON)	OFF	(ON)			
	Q1115	1MS5	ON	OFF	(ON)			
DP	Q1121	1MD1	ON	NONE	ON		N/A	2-1,5-4
	Q1122	1MD2	ON	NONE	(ON)			
	Q1123	1MD3	ON	OFF	ON			
	Q1124	1MD4	(ON)	OFF	(ON)			
	Q1125	1MD5	ON	OFF	(ON)			
	Q1126	1MD6	ON	ON	ON			
	▲ Q1127	1MD7	(ON)	ON	(ON)			
	▲ Q1128	1MD8	ON	ON	(ON)			
3P	Q1131	1M31	ON	NONE	ON		N/A	2-1,5-4,8-7
	Q1132	1M32	ON	NONE	(ON)			
	Q1133	1M33	ON	OFF	ON			
	Q1134	1M34	(ON)	OFF	(ON)			
	Q1135	1M35	ON	OFF	(ON)			
4P	Q1141	1M41	ON	NONE	ON		N/A	2-1,5-4,8-7,11-10
	Q1142	1M42	ON	NONE	(ON)			
	Q1143	1M43	ON	OFF	ON			
	Q1144	1M44	(ON)	OFF	(ON)			
	Q1145	1M45	ON	OFF	(ON)			
	Q1146	1M46	ON	ON	ON			
	▲ Q1147	1M47	(ON)	ON	(ON)			
	▲ Q1148	1M48	ON	ON	(ON)			

( ) = MOMENTARY

▲ Please confirm the availability before order.

## ▼ POLE OPTIONS

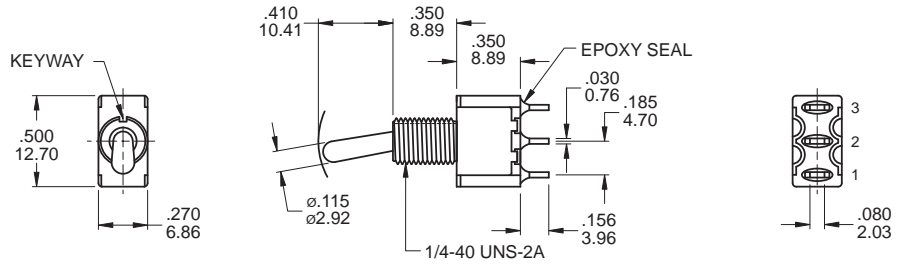

**SPDT**

Model name. 1MS1T1B1M1QES

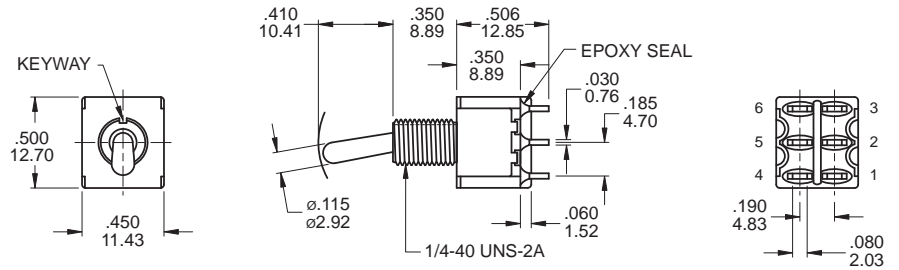

**DPDT**

Model name. 1MD1T1B1M1QES

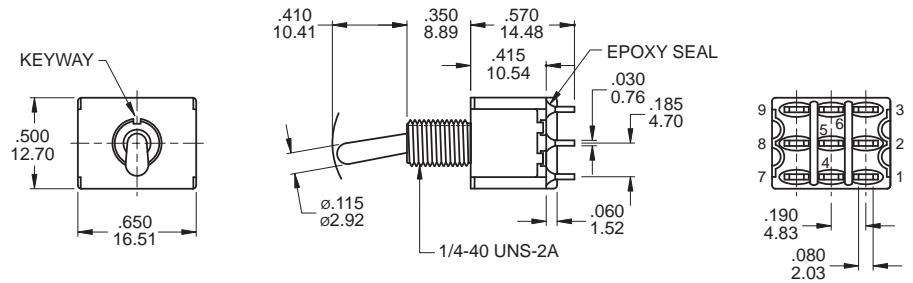

**3PDT**

Model name. 1M31T1B1M1QES

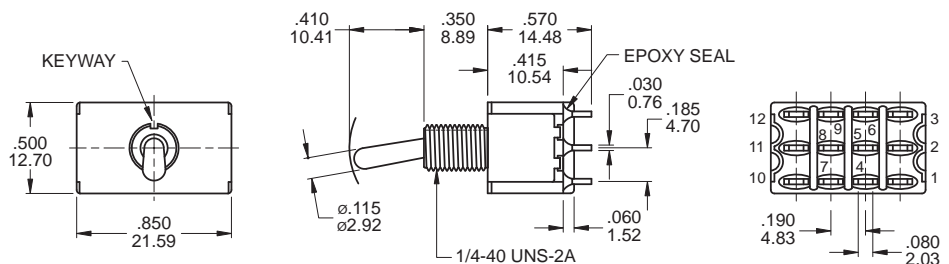

**4PDT**

Model name. 1M41T1B1M1QES

## ▼ 3-WAY SWITCH

### SINGLE POLE, 3 POSITION

Model No.	POS 1	POS 2	POS 3
1MD6	ON	ON	ON
Term. Comm.	2-3,5-6	2-3,5-4	2-1,5-4

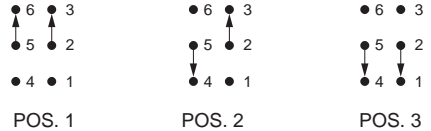
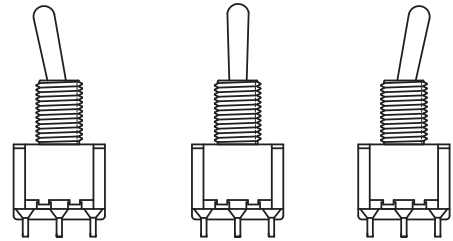
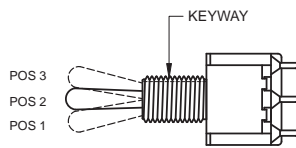

### DOUBLE POLE, 3 POSITION

Model No.	POS 1	POS 2	POS 3
1M46	ON	ON	ON
Term. Comm.	2-3,5-6 8-9,11-12	2-3,5-4 8-9,11-10	2-1,5-4 8-7,11-10

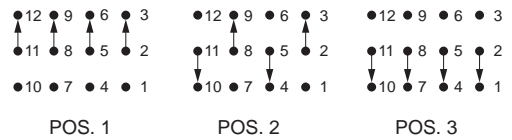
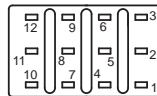

\* Diagram of the 3-way switch wiring

## ▼ ACTUATOR OPTIONS

### T1 STD

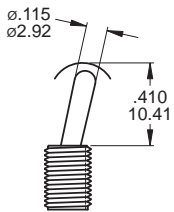

### T2

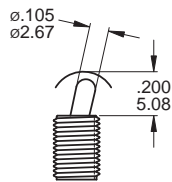

### T3

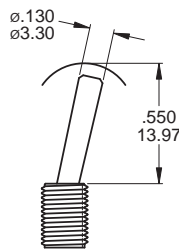

### T4

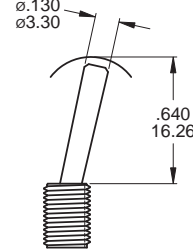

### T5

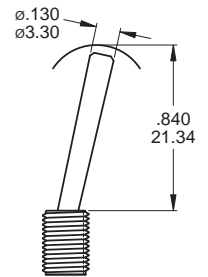

T1~T5 Actuator are shown with Bushing B1(standard) and available with Terminal M1,M2.

Note: For B3 Bushing: +.070inch(1.78mm)  
 For B6 Bushing: -.020inch(0.51mm)  
 For B1/B2 Bushing with Terminal M6, M7, VSX: -.016inch(0.40mm)

### T88B52

#### SPLASH PROOF

\* Standard function is SPDT, can only applicable with terminal M1 and M2.

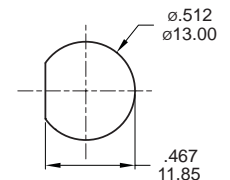
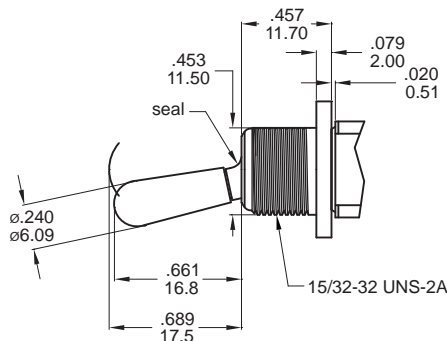
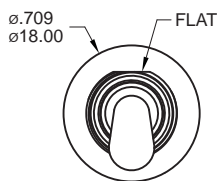

PANEL MOUNTING  
Without locking ring (Flat)

Note: T6, T61, T62, T63 can only be use with B11, B12, B15, B16 bushing.

### T6 FLATTED WITH ANTI-ROTATION

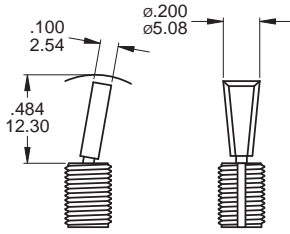

### T61

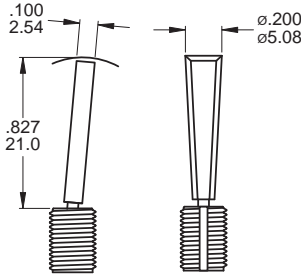

### T63

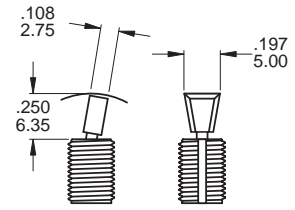

### T62 WITH BLACK CAP(STD)

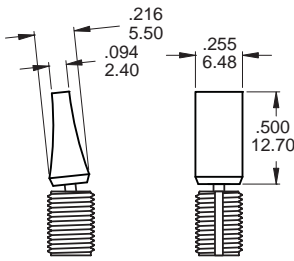

#### Plastic Color :

ITEM NO	COLOR
1	White
3	Red
4	Orange
5	Yellow
6	Green
7	Blue
9	Gray

\* Except standard color, for other colors information please consult sales representativity.

#### EXAMPLE:

1MS1T62M1QES (BLACK STD)

1MS1T62□M1QES

□ Cap Color

### T7

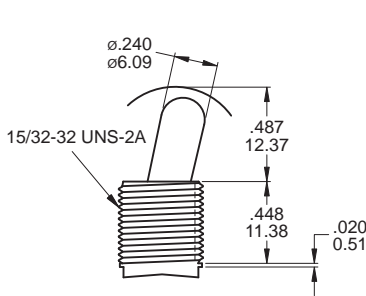

Shown with B13 bushing.  
Use with Bushing B18 and B20, the lever is antirotation and the length of lever is 13.00mm.

### T8

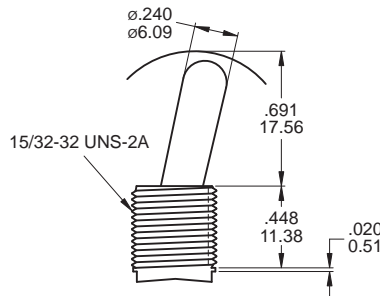

Shown with B13 bushing.  
Use with Bushing B18 and B20, the lever is antirotation and the length of lever is 18.00mm.

### T9□

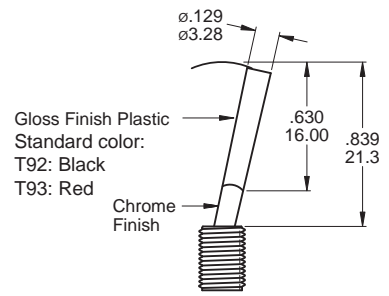

Standard for B1 and B2 bushing.

### TL1B25 THD STD B26 NON-THD

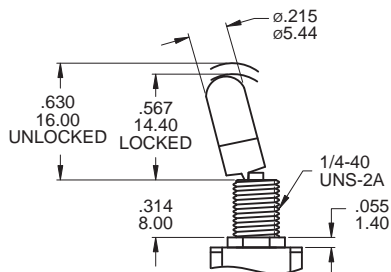

### TL2B25 THD STD B26 NON-THD

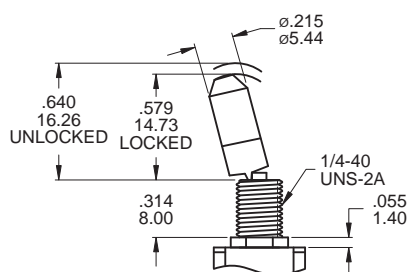

### TL3B25 THD STD B26 NON-THD

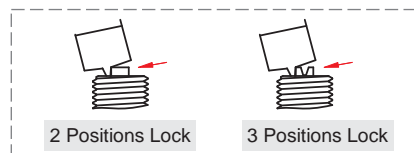
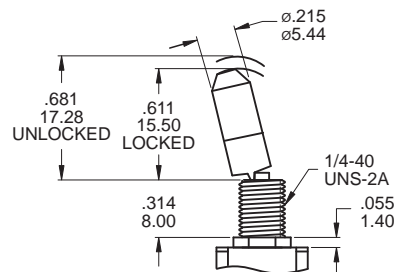

## ▼ BUSHING OPTIONS

**B1 THD STD**  
**B2 NON-THD**

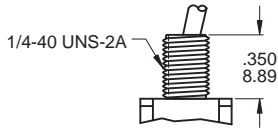
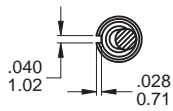

For terminal M6, M7 and VS2-5:  
-.015inch(0.39mm)

**B3 THD**  
**B4 NON-THD**

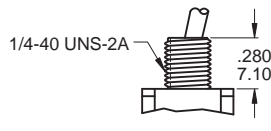
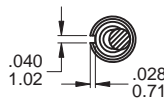

B4 is standard for terminal M6, M7 and VS2-5.

**B5 HIGH TORQUE**

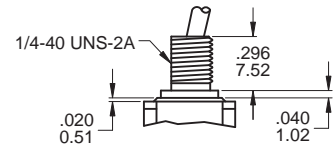
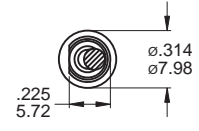

**B6 HIGH TORQUE**

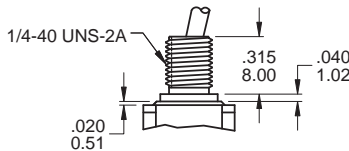
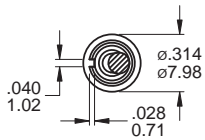

**B7 THD STD**

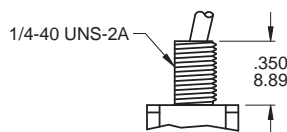
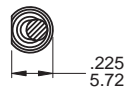

**B8 METRIC THD**

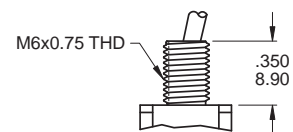
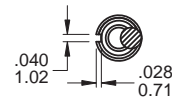

**B9 SPLASH PROOF**

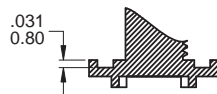
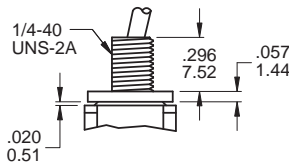
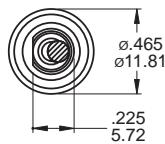
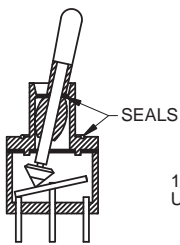

**O-RING**  
Model name. CP-1TEB

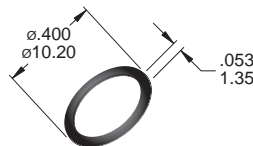

B9 bushing with O-Ring

**B11 THD STD**  
**B12 NON-THD**

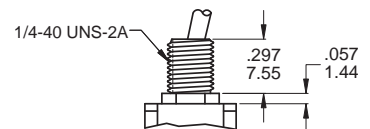
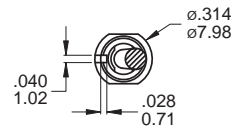

Only available for actuator T6~T63.

**B15 THD STD**  
**B16 NON-THD**

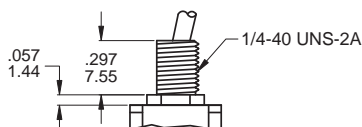
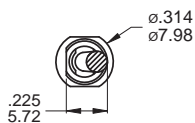

Only available for actuator T6~T63.

**B17**

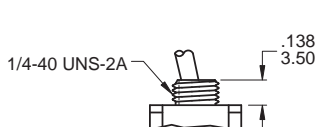
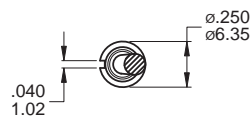

Only available for actuator T2 and the length of lever is .311inch(7.90mm).  
Standard for terminal M1, M2

**B13**

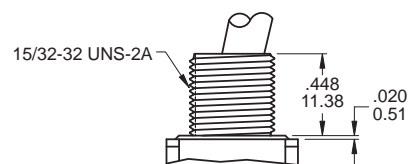
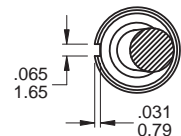

Available with actuator T7 and T8 only.  
Bear strength from top of actuator is up to 10 kg, and 15kg from aside.

## B14 SPLASH PROOF

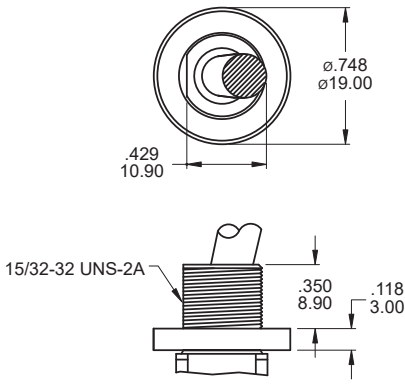

Available with actuator T7 and T8 only.

## B18 \*

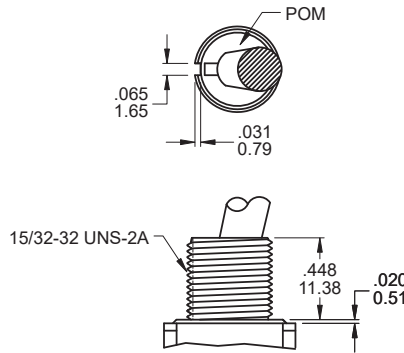

Available with actuator T7 and T8 only.  
(with Plastic (POM) Insert)

## B20 \*

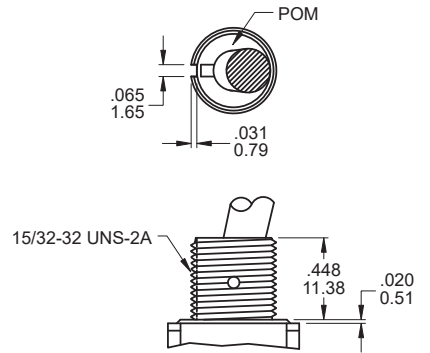

Available with actuator T7 and T8 only.  
(with Plastic (POM) Insert)

\* Bear strength from top of actuator is up to 20 kg, and 15kg from aside.

## ▼ TOGGLE CAP



Model name. MCP-1T12 (std.)  
Note: Only available for actuator T1

### CAP Color :

ITEM NO	COLOR
1	White
2	Black (Std)
3	Red
5	Yellow
6	Green
7	Blue
9	Gray

\* Except standard color, for other colors information please consult sales representativity.

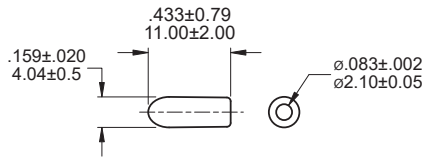

EXAMPLE:            -            T1

Model name.

Cap color

0 No hardware

5 Standard hardware

## ▼ PANEL MOUNTING

### 1/4 IN BUSHING

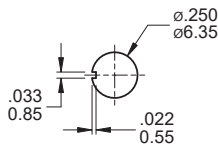

Without locking ring (Keyway)

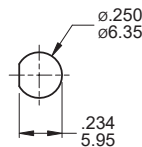

Without locking ring (Flat)

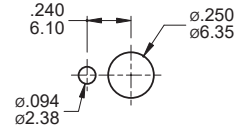

With standard locking ring.

### METRIC BUSHING

Note: For B8 bushing.

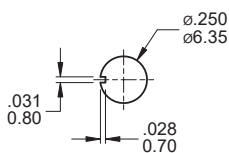

Without locking ring (Keyway)

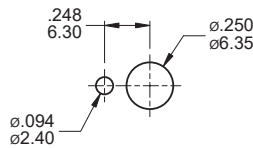

With standard locking ring.

### 15/32 IN BUSHING

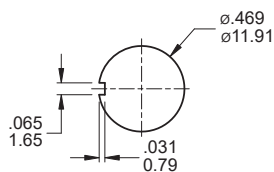

Without locking ring (Keyway)

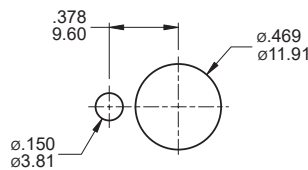

With standard locking ring.

### SPLASH PROOF BUSHING

Note: For B14 bushing.

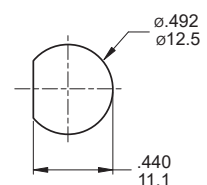

Without locking ring (Flat)



# 1M Series

Miniature Toggle Switches



Toggle Switches

## ▼ TERMINAL OPTIONS

### M1 Solder lug

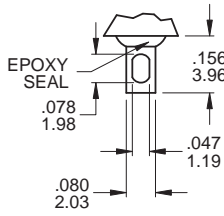

.030inch(0.76mm) THK.

### M2 PC Thru-hole

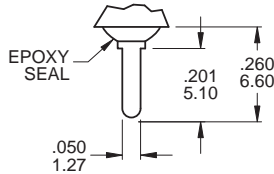

.030inch(0.76mm) THK.

### M3 Quick connect

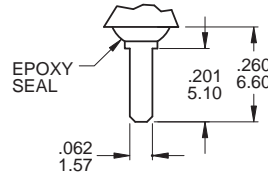

.030inch(0.76mm) THK.

### M5 Wire Wrap

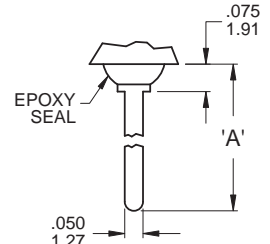

.030inch(0.76mm) THK.

## ▼ OTHER TERMINAL OPTIONS

**M6** Right angle P.C. Mount

**M7** Vertical right angle P.C. Mount

**VS2** Vertical bracket P.C. Mount

**VS3** Vertical bracket P.C. Mount

**VS5** Vertical bracket P.C. Mount

**M6N** Right angle P.C. Mount

with snap-in bracket

**V2N** Vertical bracket P.C. Mount

with snap-in bracket

OPTION CODE	DIM. 'A'
M51	.736 (18.70)
M52	.953 (24.20)
M53	.415 (10.55)
M54	1.062 (26.97)

### M6

(M6N - Snap-in)

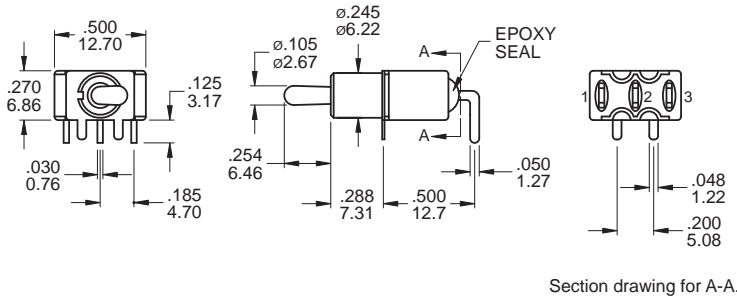

Model name. 1MS1T2B4M6QES

### PCB MOUNTING

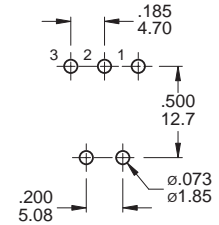

### SPDT

### M6

(M6N - Snap-in)

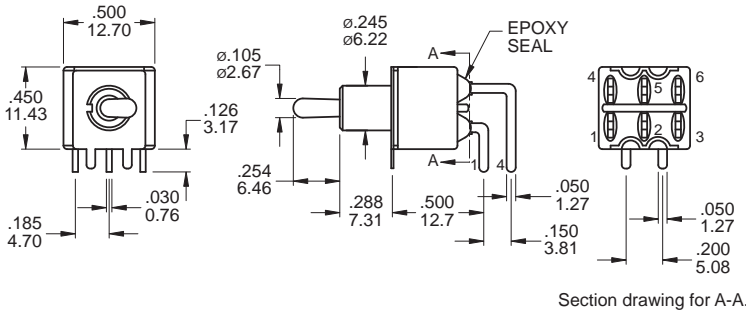

Model name. 1MD1T2B4M6RES

### PCB MOUNTING

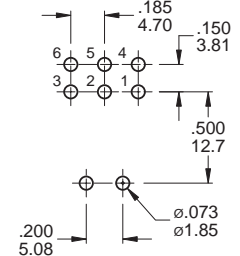

### DPDT

### M7

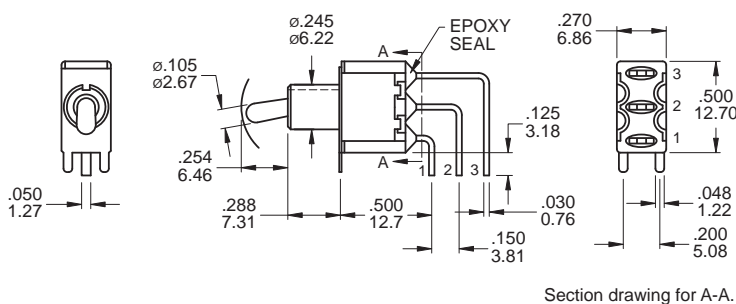
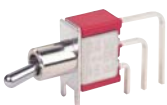

Model name. 1MS1T2B4M7QES

### PCB MOUNTING

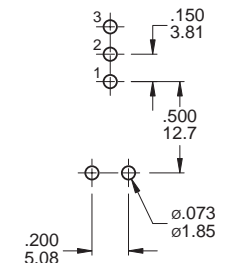

### SPDT

## M7

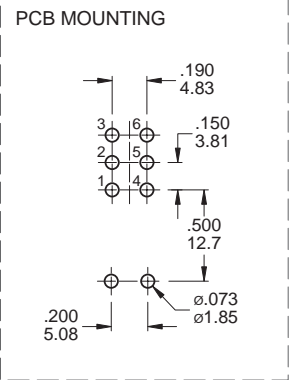
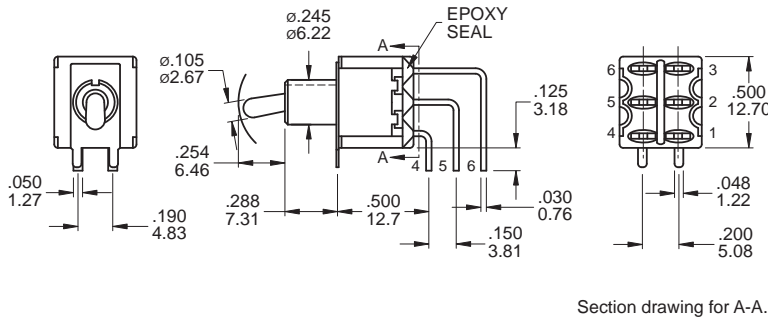

### DPDT

Model name. 1MD1T2B4M7QES

## M7

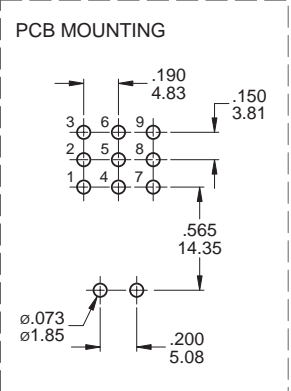
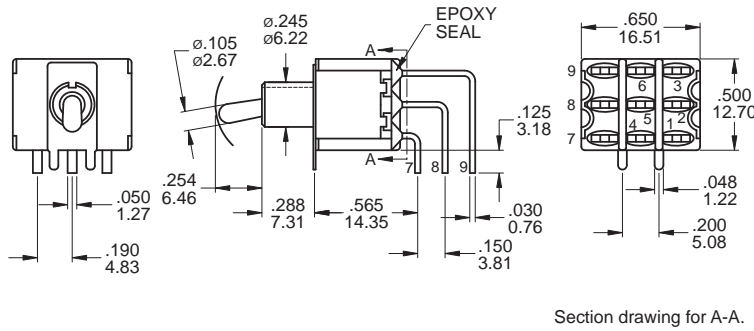

### DPDT

Model name. 1M31T2B4M7QES

## M7

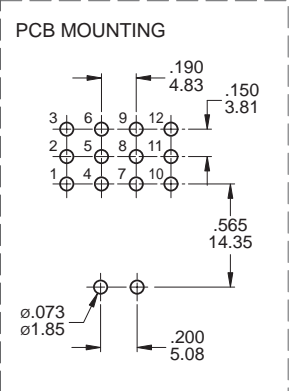
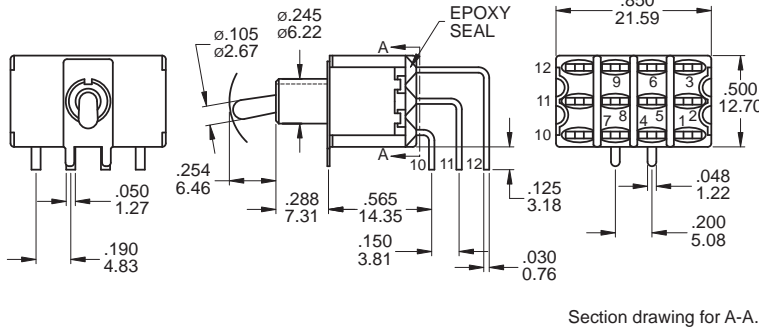

### DPDT

Model name. 1M41T2B4M7QES

## VS2 / VS3 (V2N - Snap-in)

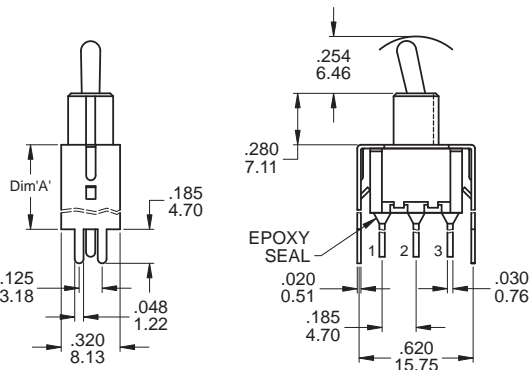

OPTION CODE	DIM. 'A'
VS2 (V2N)	.460 11.68
VS3	.630 16.00

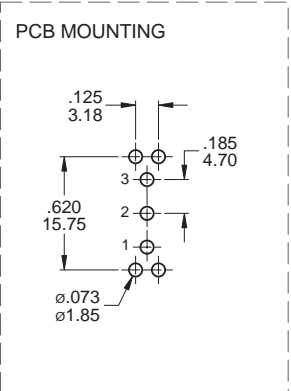

### SPDT

Model name. 1MS1T2B4VS2QES

# 1M Series

## Miniature Toggle Switches



1M Series Toggle Switches

### VS2 / VS3 (V2N - Snap-in)

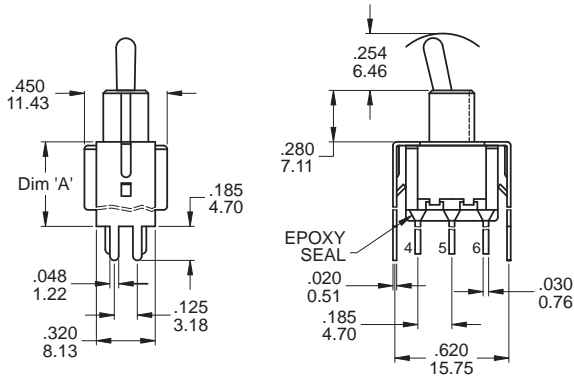

OPTION CODE	DIM. 'A'
VS2 (V2N)	.460 11.68
VS3	.630 16.00

#### PCB MOUNTING

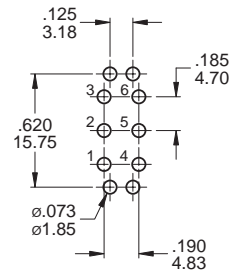

#### DPDT

Model name. 1MD1T2B4VS2QES

### VS4 / VS5

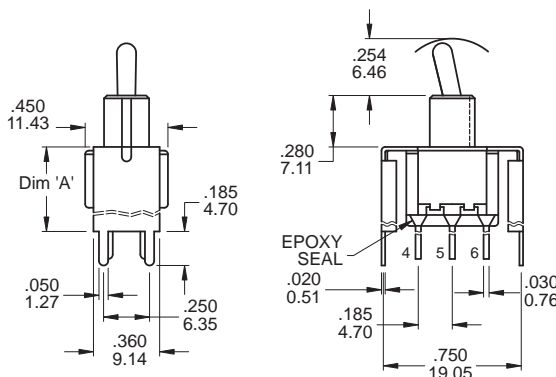

OPTION CODE	DIM. 'A'
VS4	.460 11.68
VS5	.630 16.00

#### PCB MOUNTING

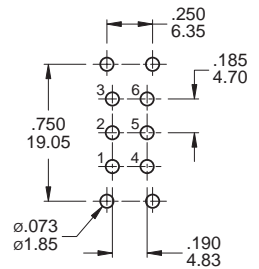

#### DPDT

Model name. 1MD1T2B4VS5QES

## ▼ SNAP-IN TERMINAL OPTIONS

### M6N

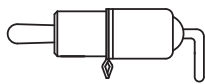

### V2N

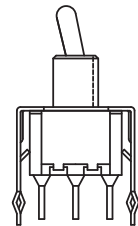

## ▼ HARDWARE

EXAMPLE:  Model name.  5 Standard hardware

\* Standard for B1 bushing : 2 nut, 1 locking ring, 1 lockwasher  
 \* For further information please consult sales representativity.

### 1/4 NUT (Std.)

Model name. MNU-1M01A

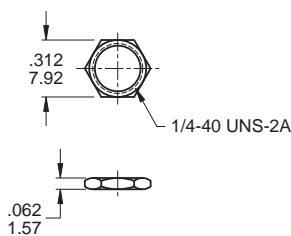

### DRESS NUT

Model name. MNU-1M29  
 MOQ: 10K

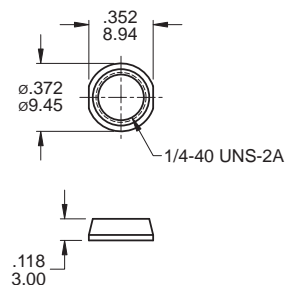

### METRIC NUT (Std.)

Model name. MNU-1M04

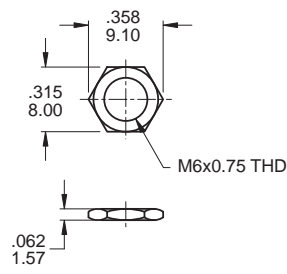

Available with bushing B8 only.

### LOCKWASHER (Std.)

Model name. MNU-1M03

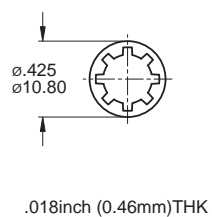

For 1/4-40 UNS-2A bushing

### LOCKING RING (Std.)

Model name. MNU-1M02

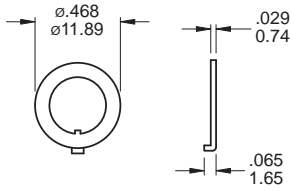

For 1/4-40 UNS-2A bushing

### LOCKING RING (Std.)

Model name. MNU-1M11

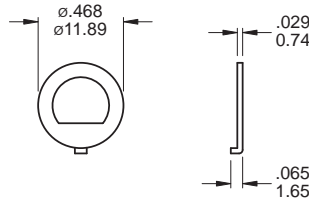

Available with bushing B5 only.

### LOCKING RING (Std.)

Model name. MNU-1M08

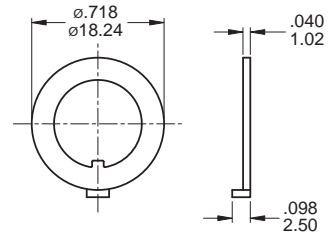

For 15/32-32 UNS-2A bushing

### LOCKING RING (Std.)

Model name. MNU-1M05

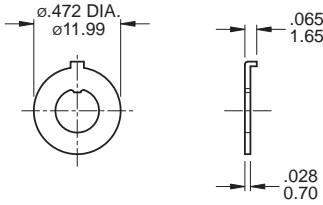

Available with bushing B8 only.

### 15/32 NUT (Std.)

Model name. MNU1M07

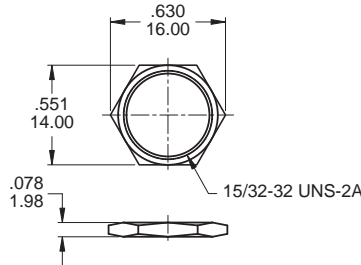

### LOCKWASHER (Std.)

Model name. MNU-1M09

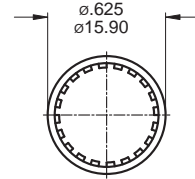

For 15/32-32 UNS-2A bushing

### RUBBER HOOD SEALING

Model name.

E1-RUBBER HOOD(Inch) (Std.)

K1-RUBBER HOOD-K1(Metric) MOQ: 2K

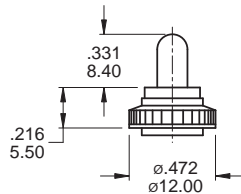

Note: For actuator T1, T2 and B1, B3, B5, B6 Bushing only

### DRESS NUT

Model name. MNU-1M18

MOQ: 10K

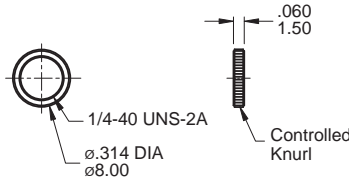

### DRESS NUT

Model name. MNU-1M24

MOQ: 10K

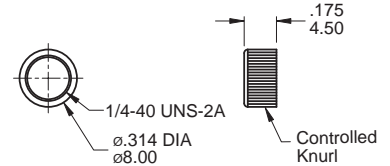

## ▼ CONTACT & TERMINAL PLATING OPTIONS

	CONTACT PLATING	TERMINAL PLATING	RATINGS
Q	Silver	Silver	5 Amps with resistant load @ 120VAC or 28VDC
C	Gold over Silver	Gold over silver	2 Amps with resistant load @ 250VAC
R	Gold	Gold	0.4 Volt - Amps ( VA ) max. @ 20V max. ( AC or DC )

## ▼ SOLDERING PROCESS

**MANUAL SOLDERING:** Use 30 watts soldering iron and controlled the temperature at 350°.

Duration of solder immersion: Max. 5 sec.

**WAVE SOLDERING:** Recommend soldering temperature: 260 ± 5°C

Duration of solder immersion: Max. 5 sec. (PCB thickness is 1.6mm)