

Product Datasheet

Screw Clamp Terminal Blocks, 6sq.mm

Screw Clamp Terminal Blocks, 50A, 600V, 20-8 AWG, 0.5-6 sq.mm

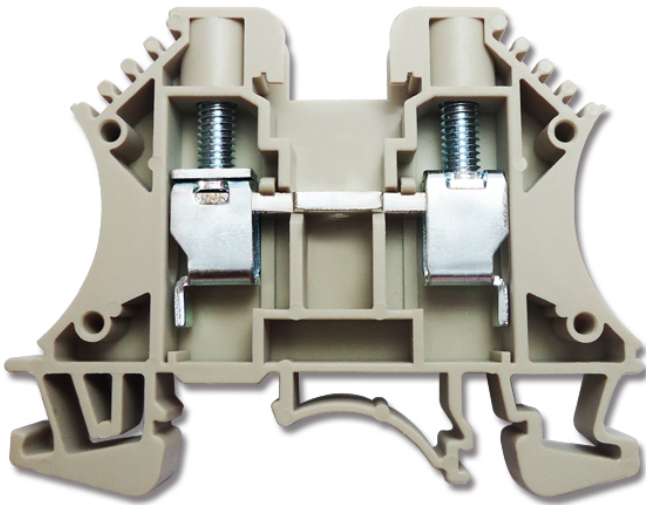

878-7534

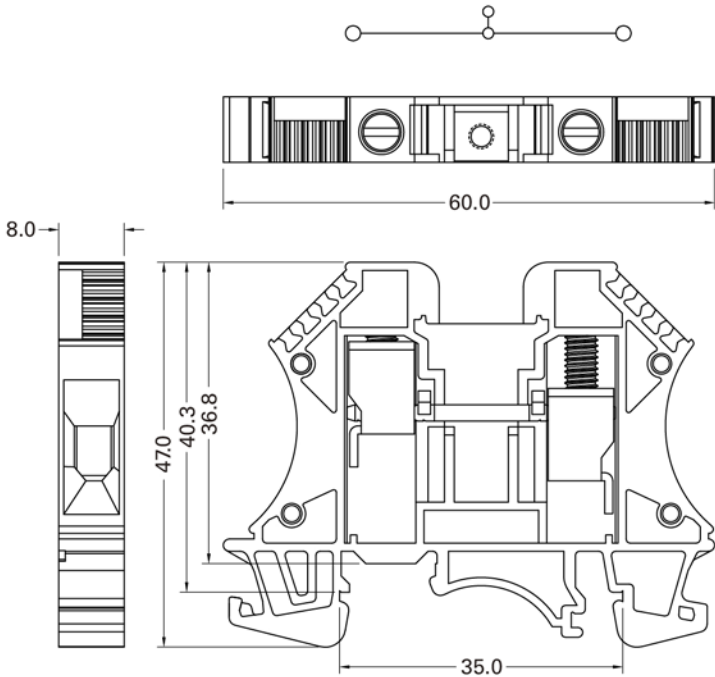

Dimensions in mm

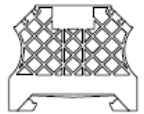
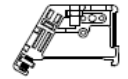
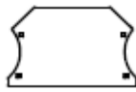

Product Specifications:

| Specifications | 6mm ² |
|--|--|
| Technical Date | Rated voltage / Rated current / Wire size |
| UL | 600V / 50A / AWG 20-8 |
| CSA | 600V / 50A / AWG 20-8 |
| IEC | 800V / 41A / 0.5-6mm ² |
| Insulating impulse voltage withstand/pollution degree | 8KV / 3 |
| Torque (in -lbs) | 14 |
| Clamping Screw (M) | M4 |
| Insulation stripping length (mm) | 12~14 mm |
| Net weight per piece | 14.7 g |
| Material / Available Color (Standard Color: Beige) |  Red Orange Beige Blue Grey White Black |
| Rail Dimensions | T / W / H (mm) |
| For TS35x7.5  | 8 x 60 x 47.5 |
| For TS35x15  | 8 x 60 x 55 |
| Accessories | Cat. No. |
| End Bracket  | 8787553 |
|  | 8787556 |
| End plate  | 8787540 |