

Features

- Push-pull latching system
- Chrome plated Brass
- IP68
- 360° Screening for full EMC shielding

RS PRO Industrial Circular Connectors

RS Stock No.: 2406421



RS PRO is the own brand of RS. The RS PRO Seal of Approval is your assurance of professional quality, a guarantee that every part is rigorously tested, inspected, and audited against demanding standards. Making RS PRO the Smart Choice for our customers.

Product Description

RS Pro's range of waterproof Chrome plated Brass push-pull locking connectors offer exceptional quality that is found in many cutting-edge connectors, including an IP68 rating and full 360° EMC shielding with a high mating life. As has become standard within the RS Pro brand you can expect high quality products but at a reasonable price. These connectors are ideal for use in medical devices, testing equipment, audio equipment and other high-end applications.

General Specifications

Number of Contacts	8
Housing Material	Chrome Plated Brass
Contact Material	Brass
Contact Plating	Gold
Contact Gender	Female
Mating Type	Cable Mount
Body Orientation	Straight
Contact Carrier	PPS
Mating Cycles	>5,000
Colour	Natural
Application	Instrumentation, Process control, Robotics, Assembly lines and manufacturing, Factory automation, Industrial production and automation, Medical devices

Electrical Specifications

Plug/Socket	Socket
Current Rating	3.8A
Test Voltage Contact-Shell k/vAC	0.95
Test Voltage Contact – Contact k/v AC	1.15

Mechanical Specifications

Connector Size	1F
Termination Method	Solder
Mounting Type	Panel Mount
Panel Cut-Out	14mm

Operation Environment Specifications

Operating Temperature	-55°C to +250°C
-----------------------	-----------------

Protection Category

IP Rating	IP68
-----------	------

Approvals

Compliance/Certifications	RoHS, CE
---------------------------	----------

FOR MATING PARTS, SEE MATRIX:



RM-F Series 1F

Plug Cable End			Mates With	Panel Mount			Or	In-Line Cable End		
RS Stock No.	No. of Contacts	Gender		RS Stock No.	No. of Contacts	Gender		RS Stock No.	No. of Contacts	Gender
2406568	2	Male	"	2406414	2	Female	"	2406499	2	Female
2406569	3	Male	"	2406415	3	Female	"	2406500	3	Female
2406570	4	Male	"	2406417	4	Female	"	2406502	4	Female
2406571	5	Male	"	2406418	5	Female	"	2406503	5	Female
2406572	6	Male	"	2406419	6	Female	"	2406504	6	Female
2406574	7	Male	"	2406420	7	Female	"	2406505	7	Female
2406575	8	Male	"	2406421	8	Female	"	2406506	8	Female
2406576	10	Male	"	2406423	10	Female	"	2406507	10	Female
2406577	12	Male	"	2406424	12	Female	"	2406508	12	Female
2406578	14	Male	"	2406425	14	Female	"	2406509	14	Female
2406579	16	Male	"	2406426	16	Female	"	2406510	16	Female

The RS PRO Seal of Approval is only awarded after a rigorous quality process to demanding international standards.



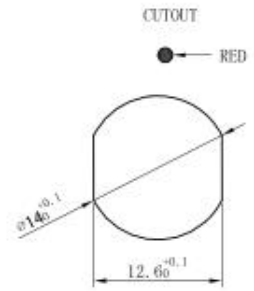
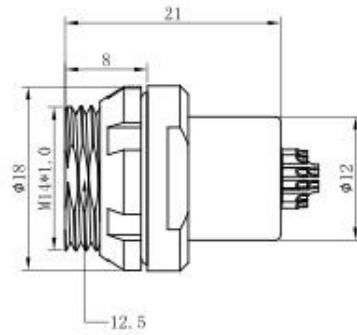

CONNECTOR SOLDER CUP VIEW

