

## FEATURES

- Non-fused DIN rail terminal blocks
- Wire size of 28AWG to 12AWG
- CSA cable size of 2.5mm<sup>2</sup>
- Current rating of 20 A (UL/CSA), 24 A (IEC)
- Voltage rating of 800V
- Screw termination
- Single level

# RS PRO, 800 V Din Rail Terminal, Screw Termination

RS Stock No.: 878-7503



RS Professionally Approved Products bring to you professional quality parts across all product categories. Our product range has been tested by engineers and provides a comparable quality to the leading brands without paying a premium price.

## Product Description

If you need to connect wires in a circuit that handles high voltages, these 2.5 mm<sup>2</sup> DIN rail terminals are a simple and effective solution. With no need for soldering or wiring, they're easy to connect and disconnect without disrupting other components.

## General Specifications

<b>Fused</b>	Non-fused
<b>Colour</b>	Grey
<b>Number of levels</b>	Single
<b>Termination method</b>	Screw Down
<b>Screw Size</b>	M2.6
<b>Rail Type Compatibility</b>	TS35x7.5 (5.1mm x 42.5mm x 47mm), TS35x15 (5.1mm x 42.5mm x 54.5mm)
<b>Contamination Degree</b>	3
<b>Application</b>	Circuit boards and control panels for industrial electronics

## Electrical Specifications

<b>Current Rating</b>	20A (UL/CSA), 24A (IEC)
<b>Voltage Rating</b>	800V
<b>Rated Impulse Voltage</b>	8kV

## Mechanical Specifications

Wire size	28AWG to 12AWG
Cable CSA	2.5mm <sup>2</sup>
Stripping Length	8mm to 10mm
Torque	5in-lbs
Unit Weight	6.1g

## Approvals







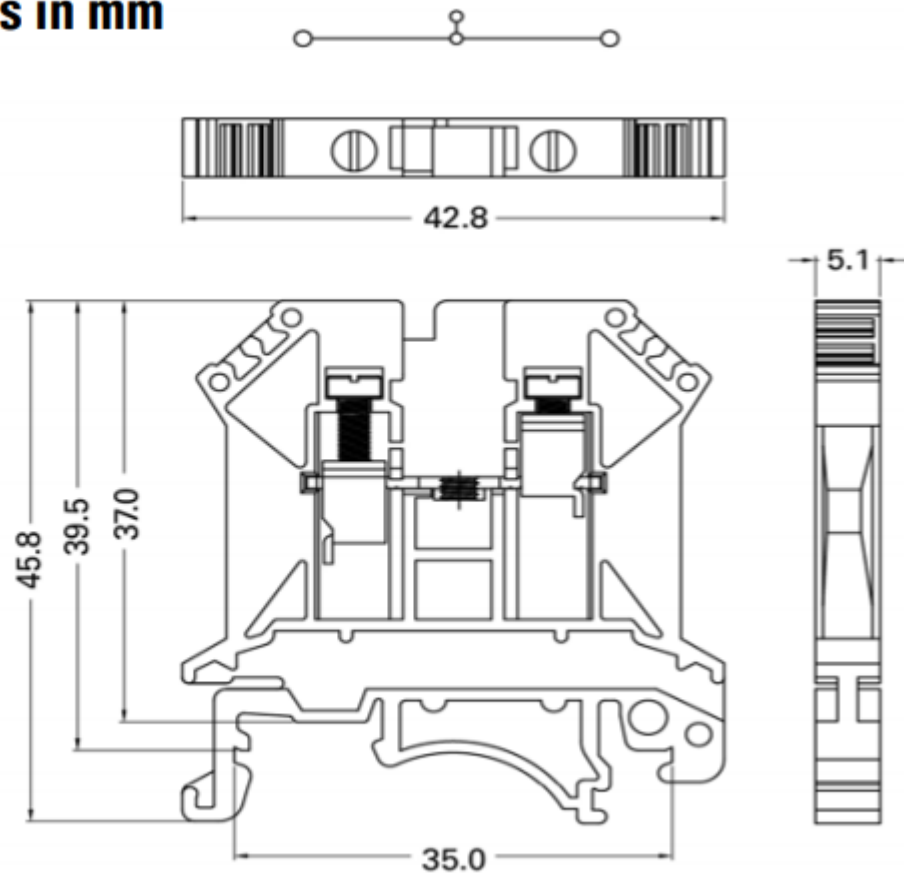

Standard met	UL, CSA, IEC, ROHS Compliant, cRUus
--------------	-------------------------------------



## Dimensions in mm



## Product Specifications:

Specifications	2.5mm <sup>2</sup>
Technical Data	Rated voltage / Rated current / Wire size
UL	600V / 20A / AWG 28-12
CSA	600V / 20A / AWG 28-12
IEC	800V / 24A / 0.5-2.5mm <sup>2</sup>
Insulating impulse voltage withstand/pollution degree	8KV / 3
Torque (in -lbs)	5
Clamping Screw (M)	M2.6
Insulation stripping length (mm)	8~10 mm
Net weight per piece	6.1 g
Material / Available Color ( Standard Color: Beige )	 Red Orange Beige Blue Grey White Black
Rail Dimensions	T/W/H (mm)
For TS35x7.5 	5.1 x 42.5 x 47
For TS35x15 	5.1 x 42.5 x 54.5
Accessories	Cat. No.
End Bracket 	8787553
End plate 	8787556
End plate 	8787544
Cross 	8787572
Marking Tags 	8787590