

Datasheet

LED Indicator Lamp

RS ITEM NO 210-030

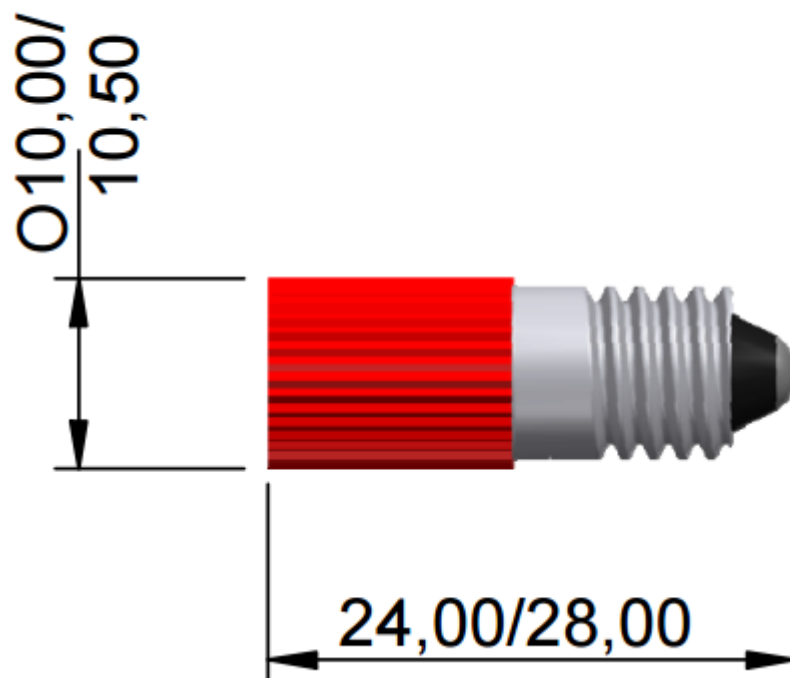

LED/Multiled	<i>Multi LED</i>	Optimum voltage (V)	<i>24Vdc</i>	Intensity	<i>40mcd</i>
Mounting Size	<i>10x24</i>	Rectifier	-		
Mounting Finish		AC current	-		
Protection	-	DC current	<i>9mA</i>		
Mount Holder	<i>E10</i>	Voltage Tolerance (%)	<i>10%</i>		
Chip Qty	<i>4</i>	Optimum temperature (°C)	<i>-30°C...+60°C</i>		
Indicator colour	<i>Red</i>	Storage temperature (°C)	<i>-30°C...+60°C</i>		
Wavelength (nm)	<i>630</i>	Contact Tab	<i>E10 Base Cap</i>		



*Dimension in mm (typical), not to scale.
We reserve the right to make changes without further notice to this product to improve reliability, function or design.*