

Datasheet

Stock No.1875674,1875675,1875676,1875706

RS PRO ORIENTING TEE MALE ADAPTOR

“UNIVERSAL SHORT” - CENTRE LEG

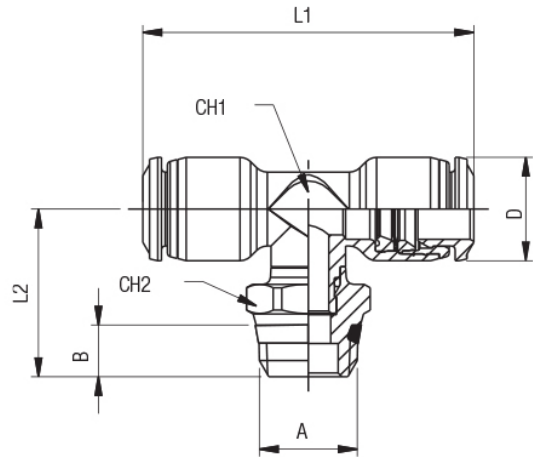

Code	Tube	A	B	L1	L2	CH1	CH2	D	Bag
1875706	4	1/8	5,5	33	18,5	7	13	10	10
1875674	4	1/4	7	33	20	7	15	10	10
	5	1/8	5,5	40	20	9	13	12	10
	6	1/8	5,5	41	20	9	13	12,5	10
	6	1/4	7	41	21,5	9	15	12,5	10
	8	1/8	5,5	44	21	10	13	14	10
	8	1/4	7	44	22,5	10	15	14	10
	8	3/8	7,5	44	23	10	17	14	10
	10	1/4	7	53	25,5	13	16	17	10
	10	3/8	7,5	53	25,5	13	17	17	10
	10	1/2	9	53	28	13	21	17	10
	12	1/4	7	60	27	16	16	20	10
1875675	12	3/8	7,5	60	27	16	17	20	10
1875676	12	1/2	9	60	29,5	16	21	20	10
	14	3/8	7,5	61	30	18	20	21	10
	14	1/2	9	61	30,5	18	21	21	10

The serie came up to answer the most extreme demands of pneumatic automation. It is a line in technopolymer, lighter and more compact which offers to demanding customers high performances.

Wide Range \varnothing 2 - 14 mm.

Main advantages

- Quick connection and disconnection
- Full Flow and Vacuum resistant tank to special shaped seals
- 3 threads available, BSPP, BSPT (universal short) & Metric
- Lighter and More compact
- Specific configurations to satisfy the advanced robotics
- Silicon Free

Applications

- Robotics
- Automotive
- Textile, Packaging, Handling
- Compressed Air Circuit
- Industrial Water
- Vacuum



Technical Characteristics

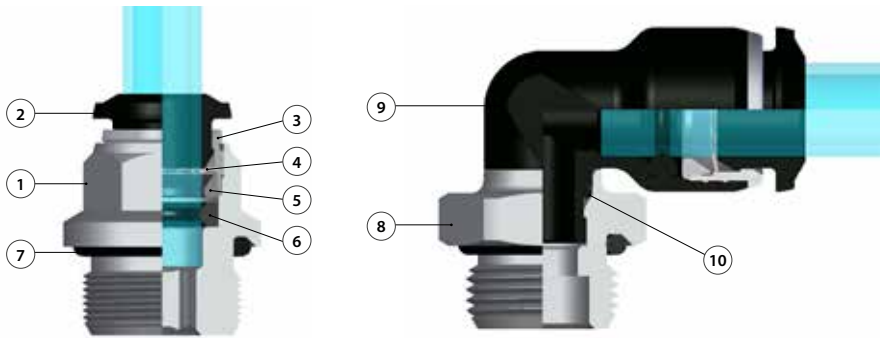

Component Parts and Materials

- Nickel-plated brass Body
- Acetalic resin Collet
- Nickel-plated brass Capsule
- Steel AISI 301 Clamping washer
- Technopolymeric positioning ring
- NBR Molded seal
- NBR Thread packing
- Base Threaded Nickel Plated Brass
- Technopolymeric Body PA
- NBR seal



Reference standard

1907/2006 REACH ✓	2011/65/CE RoHS ✓	PED 2014/68/UE	ISO 14743:2004	SILICON FREE
-----------------------------	-----------------------------	-------------------	-------------------	-----------------



Pressures

- 0.99 bar (-0.099 MPa)
20 bar (2.0 MPa)



Temperatures

- 20 °C
+ 80 °C



Fluids

Compressed air / Vacuum / Water



Connection Tubes

Plastic tubes:

PA6, PA11, PA12, Polyethylene, *Polyurethane, PTFE, FEP.

*For Polyurethane hoses it is required a minimum hardness of 98 shore.

Threads

"UNIVERSAL SHORT" Tapered thread.
Tapered gas in conformity with ISO 7.1, BS 21, DIN 2999.
Parallel gas in conformity with ISO 228 Class A.
Metric in conformity with ISO R/262.

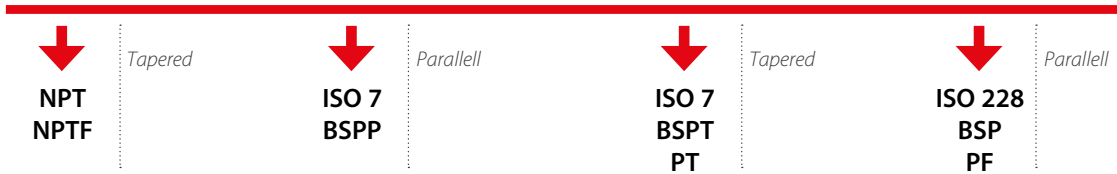
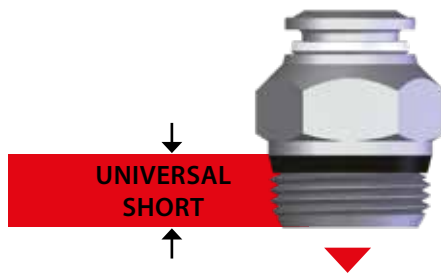

"UNIVERSAL SHORT"

The "UNIVERSAL SHORT" taper thread has been designed to offer the following advantages to the users:

- reduced overall length;
- smaller hex dimensions compared to the parallel threads;
- to allow the assembly with different female threads both taper as well as parallel.



Inclined



Concave



Convex

To ensure the right tightening also with surfaces not perfectly flat, without spot-facing, concave convex and with different kinds of chamfers or radius.



Torque specifications



ISO 228

MEASURE	RECOMMENDED TORQUE Nm	BREAKING TORQUE Nm
M5	0,8	3,2
1/8	3	8
1/4	9	30
3/8	10	60
1/2	12	50

Breaking values may vary according to the item

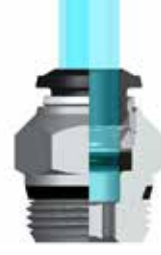

"UNIVERSAL SHORT"

MEASURE	RECOMMENDED MINIMUM TORQUE Nm	RECOMMENDED MAX TORQUE Nm
1/8	5	7
1/4	5	7
3/8	5	7
1/2	5	7

Breaking values may vary according to the item

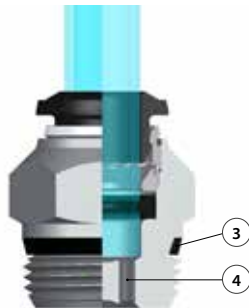
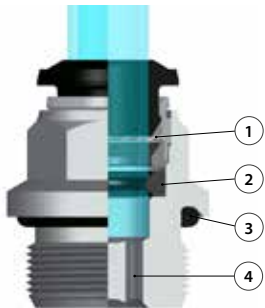

Advantages

- 1 The washer is made in stainless steel ensures the perfect tube clamping with every kinds of materials without damage the surface.
The connection between the tube and the fitting ensure a total tightness even in severe conditions such as impact and vibrations.
- 2 The particular geometric shape of the seal ensure the perfect tightness even with vacuum.
- 3 All of threads from this range have been equipped with tightening parts which allow the direct assembly of the fittings, reducing the installation time.
- 4 All the straight fittings can be assembled also with Allen wrench and it is possible to use them in reduced spaces.