

FEATURES

- RoHS Compliant
- REACH Compliant
- Silicon free

RS PRO NUT

RS Stock No.: 2305186



RS PROfessionally Approved Products bring to you professional quality parts across all product categories. Our product range has been tested by engineers and provides a comparable quality to the leading brands without paying a premium price.

Product Description

The RS PRO nut is made up of brass material. It is water, oil and compressed air compatible. Operating temperature range is from - 60 °C + 300 °C. The working pressures and working temperatures depend on which type of tube is used, for this reason, the values must be determined in accordance with the tube's features.

General Specifications

Fitting Type	Nut
Material	Brass
Fitting Direction	Straight
Application	LPG, Fluid Control, Flee & Automotive, Hydraulic

Mechanical Specifications

Compression Connection Pipe Diameter	4mm
Tube Connection	10.5mm
Threaded Connection	M8 X 1 Male
Thread Size	1mm
Thread Standard	Metric
Gender	Male
Wrench Size	10mm

Operation Environment Specifications

Service Temperature Up To	+300°C
----------------------------------	--------

Approvals

Standards Met	RoHS and REACH Compliant
----------------------	--------------------------

Similar Products

Parameters	2305189	2305190
Brand	RS PRO	RS PRO
Fitting Type	Nut	Nut
Material	Brass	Brass
Fitting Direction	Straight	Straight
Compression Connection Pipe Diameter	10mm	12mm
Tube Connection	15mm	15mm
Threaded Connection	M16 X 1.5 Male	M18 X 1.5 Male
Thread Size	1.5mm	1.5mm
Thread Standard	Metric	Metric
Gender	Male	Male
Wrench Size	19mm	22mm
Service Temperature Up To	+300°C	+300°C
Standards Met	RoHS and REACH Compliant	RoHS and REACH Compliant
Application	LPG, Fluid Control, Fleeer & Automotive, Hydraulic	LPG, Fluid Control, Fleeer & Automotive, Hydraulic

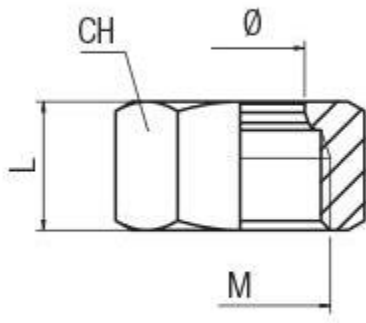

Tube	L	CH	M	Pack.
4	10.5	10	M 8x1	50