

Datasheet

RS Pro 11.8mm Plain Stainless Steel Flanged Hex Nut, M5, A2

RS Stock No: **725-9647**



Product Details

RS Pro flange hexagonal nut made of A2 grade stainless steel offers corrosion resistance. The nut has a flange diameter of 11.8 mm. It features M5 metric threading to couple with threaded rod. The nut meets all the requirements of DIN6923 standards.

Features and Benefits

- Made of A2 grade stainless steel
- M5 metric threading
- Plain faced flange
- Meet the requirements of DIN6923 standards

Specifications:

Finish	Plain
Flange Diameter	11.8 mm
Material	Stainless Steel
Overall Height	5 mm
Stainless Steel Type	A2
Thread Size	M5
Specification	DIN 6923
Type	Unserrated
Width Across Flats	8 mm

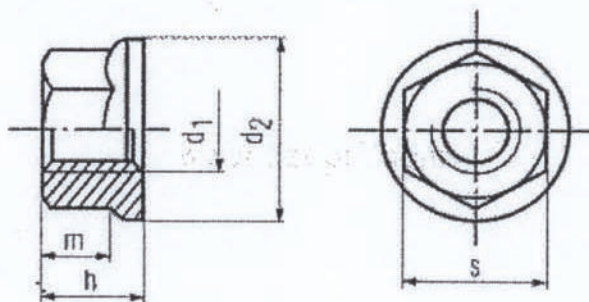

All measurements in millimeters (mm)

d ₁	d ₂	s	h
M3	8	5.5	3.7
M4	10	7	4.5
M5	11.8	8	5
M6	14.2	10	6
M8	17.9	13	8
M10	21.8	15	10
M12	26	18	12
M14	29.9	21	14
M16	34.5	24	16
M20	42.8	30	20

*All information is strictly informative

MATERIAL: STAINLESS STEEL GRADE A2