











RS PRO SY17 In-Line Cable Mount Connector

RS Stock No.: 2506109, 2506110, 2506113, 2506097, 2506108, 2506105, 2506098, 2506100, 2506101, 2506111, 2506099, 2506107, 2506114, 2506102, 2506103, 2506104.



Technical Specifications:

Number of contact	2	3	4	2B	3B	4B	5	7	9	10
Male contact face view										
Rated current (A)	10	10	5	15	15	15	5	5	5	5
Contact diameter(mm)	∅1.5X2	∅1.5X3	∅1X4	∅2X2	∅2X3	∅2X4	∅1X5	∅1X7	∅1X9	∅1X10
Rated voltage (AC.V)	500	500	500	500	500	500	500	400	400	400
Test voltage(AC.V) 1 min	1500	1500	1500	1500	1500	1500	1500	1200	1200	1200
Contact resistance (mΩ)	2.5	2.5	5	2.5	2.5	2.5	5	5	5	5
Wire size (mm ² /AWG)	≤2/14	≤2/14	≤0.75/18	≤2/14	≤2/14	≤2/14	≤0.75/18	≤0.75/18	≤0.75/18	≤0.75/18

Product Details

The RS Pro SY17 series is a range of lightweight but robust waterproof connectors, which are sealed to IP67. Bayonet coupling ensures a quick and secure connection, even in the harshest environments. Versions are available for in-line cable to cable and for cable to panel connections. Plugs and receptacles are available with either male pins or female sockets. These products are ideal for use in outdoor applications where a secure, waterproof connection is required.

Features and Benefits

- Bayonet Coupling
- IP67
- 2-10 Poles
- Cable to Cable and Cable to Panel Connections



Dimensional line drawings

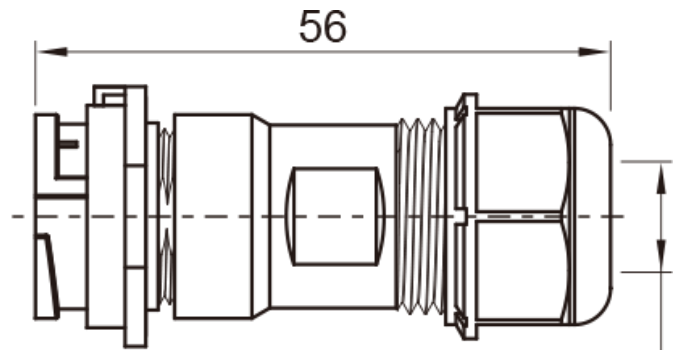
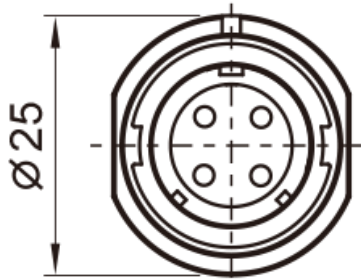

Cable outer diameter range: 6-10mm

Quality Standards

