

Datasheet

RS PRO IP67 D-Sub – Plastic Serial Cable End



The RS PRO series of waterproof D-sub connectors are a range of ruggedised IP67 connectors designed to be used outdoors or in harsher industrial environments. Designed to fit panel cut outs of 40.0mm the waterproof D-sub series also comes with rear potting on the panel mount connectors. This ensures your panel is still sealed to an IP67 rating even when the connector is unmated. The Push-Fit with dual Screws mating allows for a secure connection.

Features & Benefits:

- Thermoplastic
- IP67
- Rear Potted
- Push-Fit with Dual Screws Mating

Quality Standards



Dimensional line drawings

122-3040

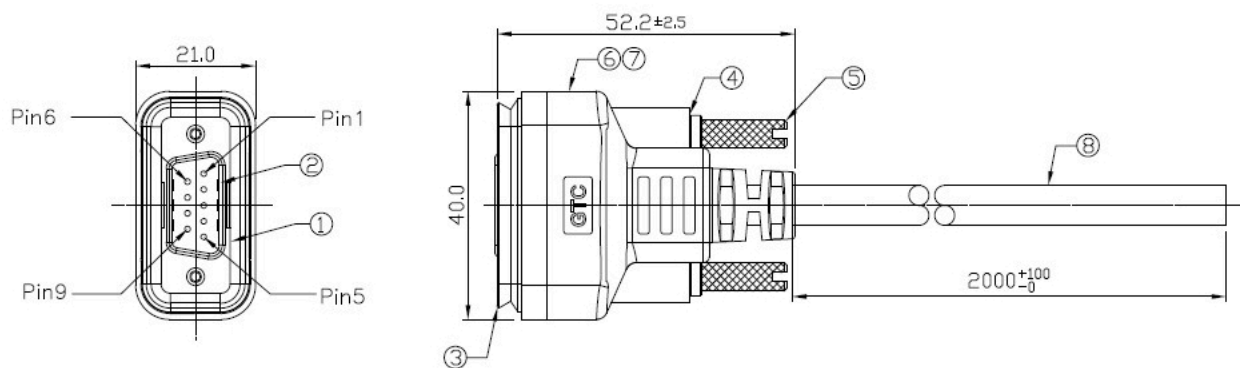

1	Brown
2	Blue
3	Orange
4	Green
5	Yellow
6	Gray
7	Violet
8	Red
9	Black
Shell	Drain

Wiring Diagram