



Datasheet

RS PRO Heat Sink Enclosure Model EABS

Stock number: 188-1305

EN



Designed for both professional users and home hobbyists alike, EABS features extruded aluminum heatsink top cover.

Features

- Extruded AL top cover provides excellent cooling.
- Suitable for power amp and other high heat generating application.
- Robust steel base and end plate
- Simple and easy to assemble.
- Black Powder Coat or natural aluminum color.

Standards and Materials

- Conforms to IEC-60297-3.
- Premium grade aluminum sheet: AL 5052 and extrusion: AA 6063 (Aluminum Alloy).
- Designed and manufactured under ISO 9001:2015 and ISO 14001:2015
- All materials RoHS compliant.

Models and Dimensions

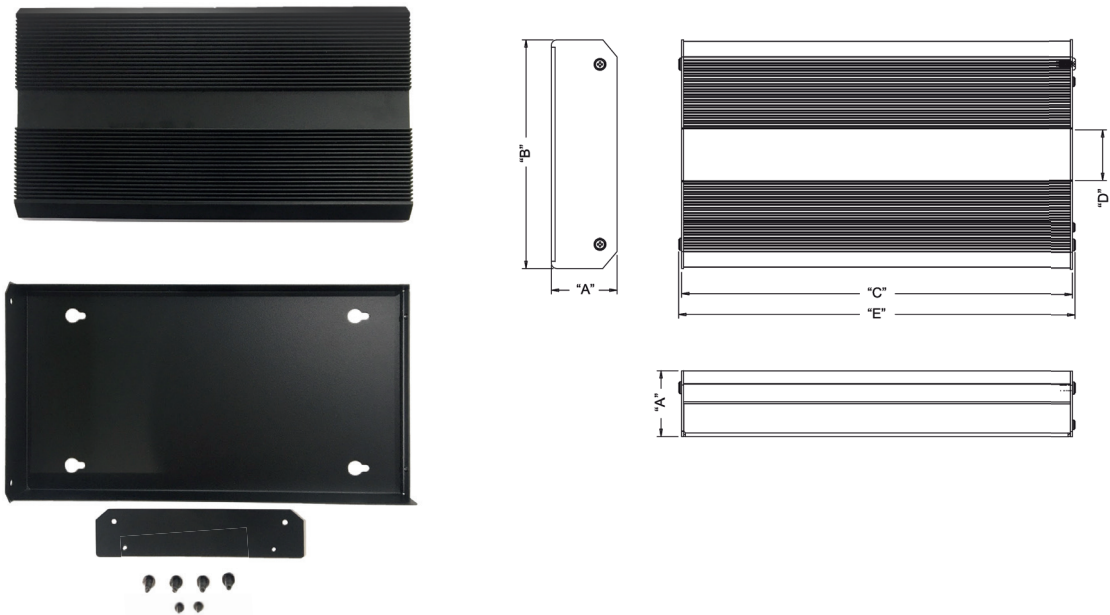

No.	Model	Dimension unit mm.					Net Weight (kg)	Shipping Weight (kg)
		"A"	"B"	"C"	"D"	"E"		
1	EABS 4.0-50-300D	50	175	299	40	305	1.98	2.18
2	EABS 4.0-50-400D	50	175	399	40	405	2.24	2.44
3	EABS 5.0-50-300D	50	219	299	40	305	2.36	2.57
4	EABS 5.0-50-400D	50	219	399	40	405	2.52	2.74
5	EABS 6.0-50-300D	50	264	299	40	305	2.74	2.88
6	EABS 6.0-50-400D	50	264	399	40	405	3.10	3.30

EABS Product Guide

1. Drilling guide by the model size

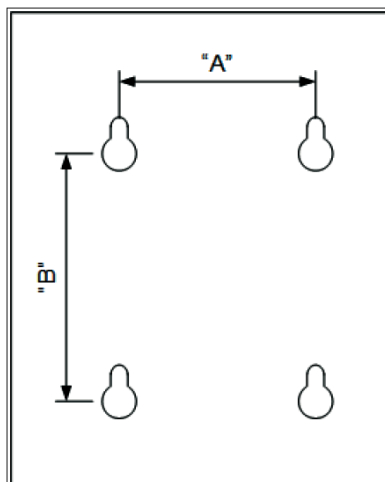

Model	Ref. "A"	Ref. "B"
EABS 4.0-50-300D	114.00	198.50
EABS 4.0-50-400D	114.00	298.50
EABS 5.0-50-300D	158.50	198.50
EABS 5.0-50-400D	158.50	297.20
EABS 6.0-50-300D	203.00	197.20
EABS 6.0-50-400D	203.00	297.20

2. Product part guide

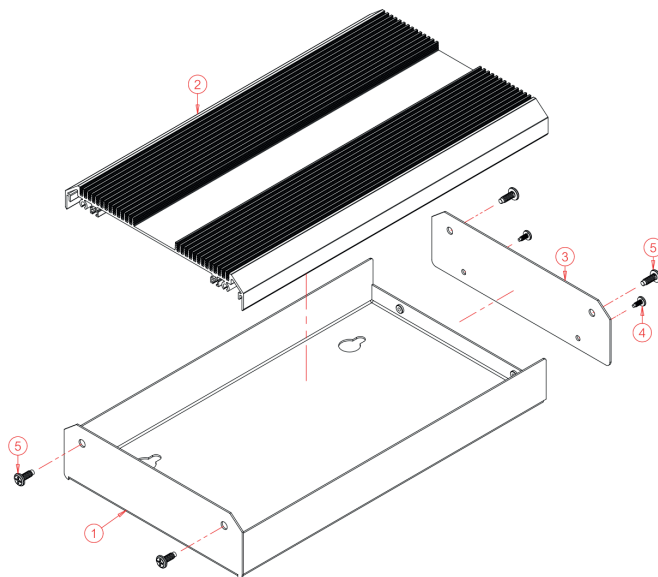

No.	Model	Qty
1	Cover Base	1
2	Cover Top	1
3	Rear Panel	1
4	Umbrella Phillips Screw M3-6	1
5	Umbrella Phillips Screw M5-10	1

Does not include hardware wall mounting.

3. Wall mounting guide

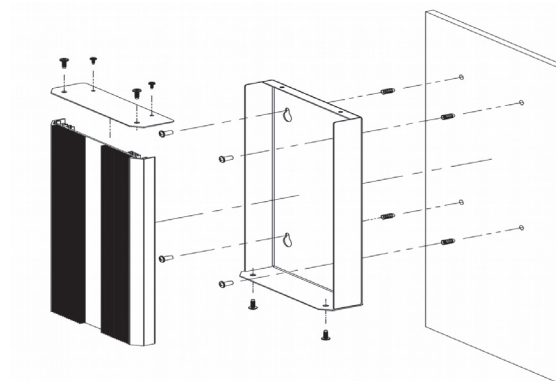

Specifications

Attribute	Value
Product 188-1305	EABS 6.0-50W-300D
External Width	264mm
External Depth	299mm
External Height	50mm
External Dimensions	264 x 299 x 50
Body Material	Aluminum Extrusion
IP Rating	IP40
Color	Black
Lid Color	Black
Flanged	No
Shielded	No
Gasket Material	No
Standard Met	ROHs Compliant
Application	Electrical, Electronic, Industrial