

Datasheet

Steel 40 Teeth Spur Gear, 32mm Pitch Diameter, 19mm Hub Diameter, 8mm Bore Diameter

RS Stock number 878-7887

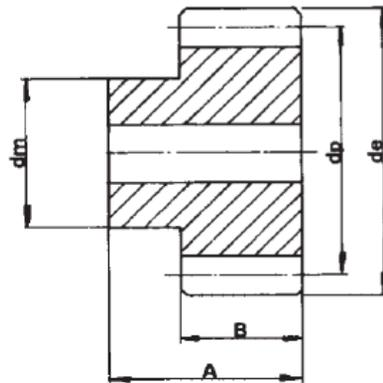

Type B

Description:

Steel Metric Spur Gears

A range of steel spur gears in a range of gear ratios.

- Steel EN8 (080M40/080M46) or equivalent
- Tensile strength: 569N/mm² (min.)
- 20° pressure angle
- DIN Standard - DIN 867, DIN 3962, DIN 3963, Grade / Quality 9 or equivalent

Specifications:

Bore Diameter:	8mm
Face Width B:	6mm
Hub Diameter (dm):	19mm
Material:	Steel
Module:	0.8
Number of Teeth:	40
Pitch Diameter (dp):	32mm
Outside Diameter (de):	33.6mm
O/A Width A:	14

Spur Gears 0.8 MOD - 20° p.a.

Steel EN8, (080M40/080M46) or equivalent

ENGLISH

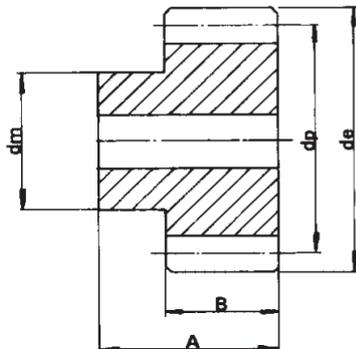

Type B

Intermediate sizes & Special gears to drawing up to 1000mm diameter
Standard : to DIN 867, DIN 3962, DIN 3963, Grade / Quality 9 or Equivalent
Standard tolerances, unless otherwise stated $\pm 0.25\text{mm}$.

Code	Type	No. of Teeth	Pitch \varnothing dp	Bore \varnothing H8	Hub/Boss \varnothing dm	Outside \varnothing de	O/A Width A	Face Width B
SS08/12B**	B	12	9.6	4	11.2	11.2	14	6
SS08/15B	B	15	12	4	9.6	13.6	14	6
SS08/16B	B	16	12.8	4	10	14.4	14	6
SS08/18B	B	18	14.4	5	12	16	14	6
SS08/20B	B	20	16	6	12	17.6	14	6
SS08/24B	B	24	19.2	6	12	20.8	14	6
SS08/25B	B	25	20	6	12	21.6	14	6
SS08/30B	B	30	24	6	12	25.6	14	6
SS08/32B	B	32	25.6	6	12	27.2	14	6
SS08/35B	B	35	28	8	19	29.6	14	6
SS08/40B	B	40	32	8	19	33.6	14	6
SS08/45B	B	45	36	8	19	37.6	14	6
SS08/50B	B	50	40	8	19	41.6	14	6
SS08/55B	B	55	44	8	19	45.6	14	6
SS08/60B	B	60	48	10	22	49.6	14	6
SS08/64B	B	64	51.2	10	22	52.8	14	6
SS08/65B	B	65	52	10	22	53.6	14	6
SS08/70B	B	70	56	10	22	57.6	14	6
SS08/75B	B	75	60	10	22	61.6	14	6
SS08/80B	B	80	64	10	22	65.6	14	6
SS08/90B	B	90	72	10	22	73.6	14	6
SS08/95B	B	95	76	10	22	77.6	14	6
SS08/96B	B	96	76.8	10	22	78.4	14	6
SS08/100B	B	100	80	10	26	81.6	14	6
SS08/120B	B	120	96	10	26	97.6	14	6

** Gears SS08/12B is a hobbed type pinion and has cutter runout after the 6 mm face width