

Rating	10A 125V, 6A 250V AC	Mo int Hole	Circuit Structure
	6A 250V ~		
Contact R	50m ohm Max.		
Insulation R	DC 500V 100M ohm Min.		
Dielectric Strength	AC 1500V 1 minute	Thickness	
Operation Temperature	-20°C~85°C	0.75...1.25	19.2-0.1 13+0.1
Circuit	2P SPST ON-OFF	1.25...2	19.4-0.1 13+0.1
		2...3	19.8-0.1 13+0.1

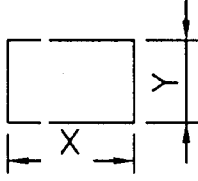

SCI NO	Actuator Color	Print Color
1821766	BLACK/BLUE	BLUE
1821501	BLACK/RED	RED

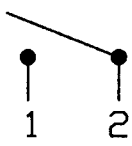
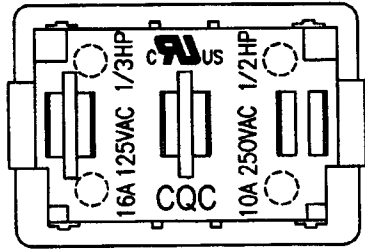
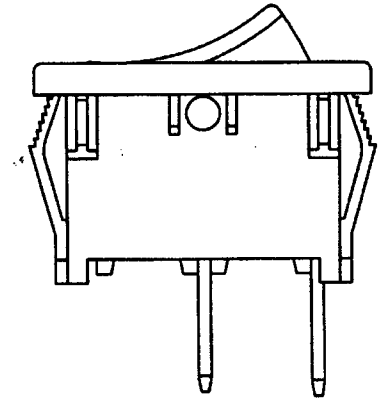
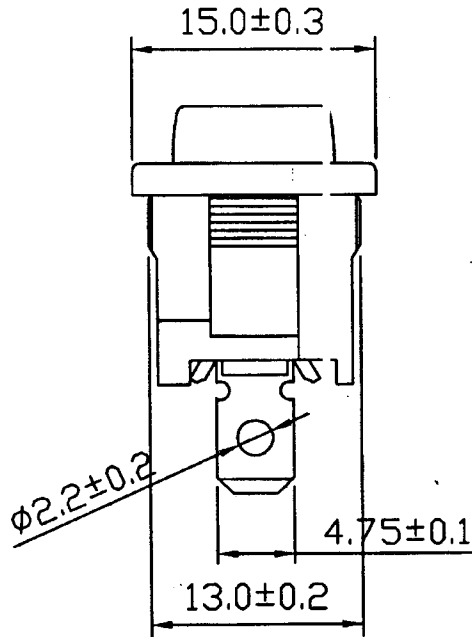
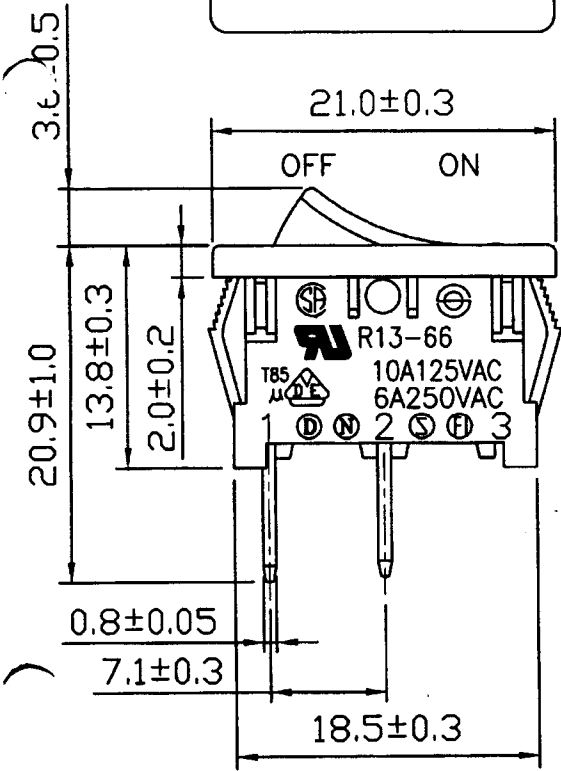
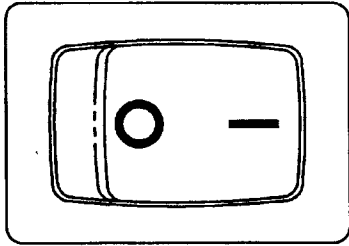

△	10/2/06	純	電 PDM	CI-PDM R13 R13-66A3 → BBNN-2 (外觀)		
△	Date	Name	Descriptions			
Drawing	Check	Approval	SCI No.		Model Name	ROCKER SWITCH
Betty			Customer No.		Model No.	R13-66A3-02-BBNN-2
09/11/06	9/13-06	9/14-06	Unit	mm		