

3-Phase Voltage Monitoring Relays

FEATURES

- Compact 17.5mm DIN rail housing
- Microprocessor based
- True R.M.S. monitoring measuring phase to phase (3-wire) or phase to neutral (4-wire) voltages
- Selectable nominal voltages to suit most popular 3-wire or 4-wire supply voltages
- Monitors own supply and detects an Under voltage condition on one or more phases
- Detects incorrect phase sequence, phase loss and neutral loss¹
- Adjustment for Under voltage trip level
- Adjustment for Time delay
- DPDT relay output 5A
- Green LED indication for supply status
- Red LED indication for relay status

¹ When 4-wire monitoring selected

RS PRO 3-Phase Failure/Sequence & Undervoltage Relay

RS Stock No.: 2257388

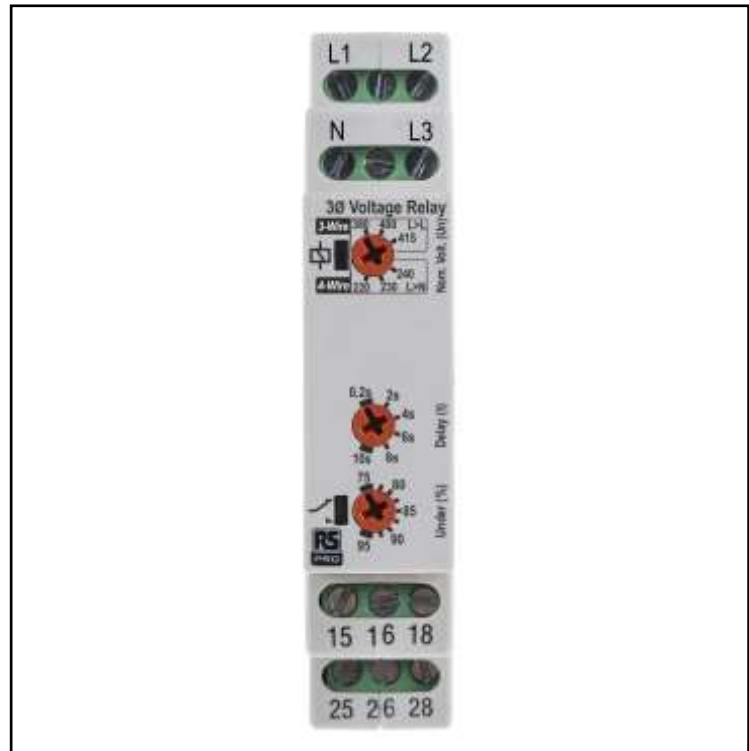

RS Professionally Approved Products bring to you professional quality parts across all product categories. Our product range has been tested by engineers and provides a comparable quality to the leading brands without paying a premium price.

3-Phase Voltage Monitoring Relays

Product Description

A 3-Phase Voltage monitoring relay for connecting to a 3-wire or 4-wire supply. The product is designed to monitor its own supply and in conjunction with an external contactor, disconnect the supply to the load/equipment in the event of a fault occurring.

For the output relay to energise, all phases (and neutral – if applicable) must be present, phase sequence correct and measured phase voltages above the set trip level. If any of these conditions are not met, the relay (+ contactor) will de-energise, disconnect the supply and thus protect the equipment.

General Specifications

Monitoring mode:	Undervoltage		
Phase sequence detection:	Yes		
Trip levels:			
Under [2]:	Fixed $\pm 2\%$ see below		
Under:	75 – 95%		
Measuring ranges:	Nominal (Un)	Under [2]	Under
3-wire (L>L):	380V	243V	285 – 361V
	400V	256V	300 – 380V
	415V	265V	311 – 394V
4-wire (L>N):	220V	140V	165 – 209V
	230V	147V	173 – 219V
	240V	153V	180 – 228V
Hysteresis:	$\approx 2\%$ of trip level (factory set)		
Setting accuracy:	$\pm 3\%$		
Repeat accuracy:	$\pm 0.5\%$ at constant conditions		
Immunity from micro power cuts:	<50ms		
Response time (tr):	$\approx 50\text{ms}$		
Time delay (t):	0.2 – 10s ($\pm 5\%$)		
Power on delay (Td):	$\approx 1\text{s}$ (worst case = Td x 2)		
Reset time:	50 – 100ms		
Power on indication:	Green LED		
Relay status indication:	Red LED		

3-Phase Voltage Monitoring Relays

Mechanical Specifications

Housing:	Grey flame retardant UL94
Dimensions:	To DIN 43880. Width 17.5mm
Weight:	90g
Mounting option:	On to 35mm symmetric DIN rail to BS EN 60715 or direct surface mounting via 2 x M3.5 or 4BA screws using the black clips provided on the rear of the unit.

Electrical Specifications

Input:	L1, L2, L3, N
Supply/monitoring voltage Un:	<i>There are 6 nominal voltages to choose from on this product</i>
3-wire monitoring:	380, 400, 415V AC
4-wire monitoring:	220, 230, 240V AC
Frequency range:	48 – 63Hz
Supply variation:	243- 540V AC (L>L)
Overvoltage category:	III (IEC 60664)
Rated impulse withstand voltage:	4kV (1.2/50µS)
Power consumption (max.):	2.5VA
Output:	15, 16, 18 / 25, 26, 28
Relay configuration:	DPDT
Output rating:	AC1 – 250V 5A, AC15 – 250V 2A, DC1 – 25V 5A
Electrical life:	≥ 150,000 ops at rated load
Dielectric voltage:	2kV AC (rms) IEC 60947-1
Rated impulse withstand voltage:	4kV (1.2/50µS) IEC 60664

Protection Category

IP Rating	IP20 (Terminal Protection)
------------------	----------------------------

Additional Information

Custom Tariff Number	85394900
-----------------------------	----------

3-Phase Voltage Monitoring Relays

Approvals

Declarations	CE, RoHS and C-tick compliant
Standards Met	EMC: Immunity EN 61000-6-2, Emissions: EN 61000-6-4

Function Diagram

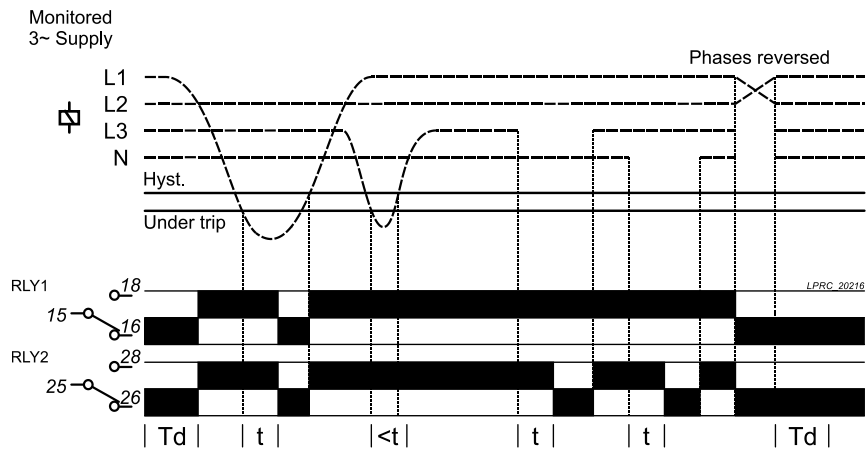

Setting Details



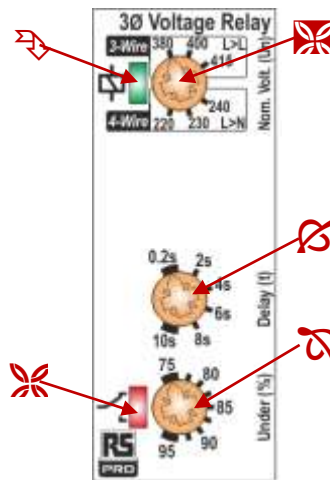

1. Power supply status (Green) LED
2. Relay output / Timing status (Red) LED
3. "Nominal (U_n)" voltage selector
4. "Delay (t)" adjustment
5. "Under %" trip adjustment



3-Phase Voltage Monitoring Relays

Setting Up



Applying power.

- Set the “Nominal (Un)”  voltage selector to match that of the voltage being monitored.
- Set the “Under %”  adjustment to minimum. Set the “Delay (t)”  to minimum.
- Apply power and the green “Power supply”  LED will illuminate. The red LED  will illuminate and relay energise after the short Power on delay (Td).
- Refer to the troubleshooting table if the unit fails to operate correctly.

Setting the unit (with power applied).

- Accurate setting can be achieved by adjusting the trip level “Under (%)” until the unit trips (relay de-energises) then by decreasing the trip level “Under (%)” until the relay re-energises. Close setting of the trip level ensures the unit will detect a phase loss even with a large percentage of regenerative voltage.
- In order to set the unit as previously described but without causing disruption to the equipment being controlled/monitored, set the “Delay (t)” to maximum. It will now be possible to establish the trip point when the red LED starts to flash. Decrease the trip level setting to stop the LED flashing. (Note: If the time delay is allowed to expire, the output relay will de-energise)
- If large supply variations are anticipated, the trip level should be set further from the nominal voltage.
- Set the “Delay (t)” as required. (Note that the delay is only effective should the supply drop below the set trip level. However, if during an undervoltage condition the supply drops below the 2nd under voltage trip level, any set time delay is automatically cancelled and the relays de-energise).

Fault Diagnostics

Supply fault:	Green LED 	Red LED 	Relay
Phase or neutral missing	LED's flash alternately		De-energised
Phases reversed (no delay)	Flashing	Off	De-energised
Undervoltage condition (during timing)	On	Flashing	Energised for delay (t)
Undervoltage condition (after timing)	On	Off	De-energised
Phases < fixed under trip level [2]	On	Off	De-energised

3-Phase Voltage Monitoring Relays

Connection Diagram

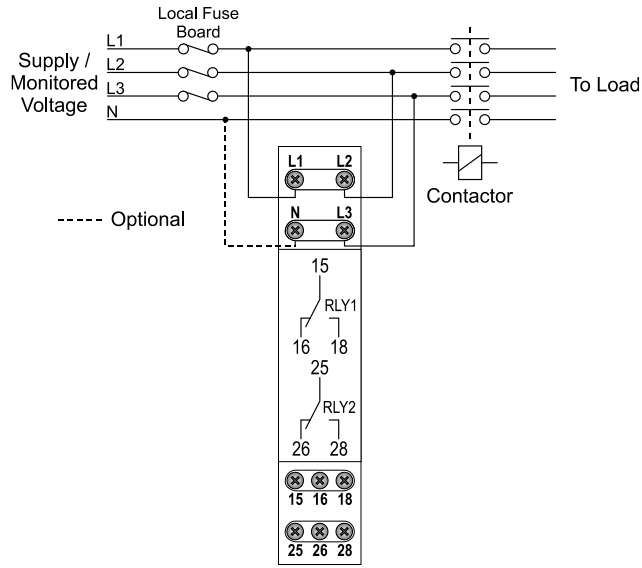

Dimensions

