







Datasheet

# RS PRO SP17 Cable Mount Connector Set



## Technical Specifications:

Number of contact	2	3	4	5	7	9	10
Male contact face view							
Rated current (A)	10A	10A	5A	5A	5A	5A	5A
Contact diameter	∅ 1.5×2	∅ 1.5×3	∅ 1×4	∅ 1×5	∅ 1×7	∅ 1×9	∅ 1×10
Rated voltage(AC.V)	500V	500V	500V	500V	400V	400V	400V
Test voltage(AC.V)1 min	1500V	1500V	1500V	1500V	1200V	1200V	1200V
Contact resistance mΩ	2.5	2.5	5	5	5	5	5
Wire size mm <sup>2</sup> /AWG	≤2/14	≤2/14	≤0.785/18	≤0.785/18	≤0.785/18	≤0.785/18	≤0.785/18

## Product Details

The RS Pro SP17 series is a range of lightweight but robust waterproof connectors, which are sealed to IP68. Threaded coupling ensures a secure connection, even in the harshest environments. Versions are available for in-line cable to cable and for cable to panel connections. Plugs and receptacles are available with either male pins or female sockets. These products are ideal for use in outdoor applications where secure, waterproof connection is required.

## Features and Benefits

- Threaded Coupling
- IP68
- 2-10 Poles
- Cable to Cable and Cable to Panel Connections



## Dimensional line drawings

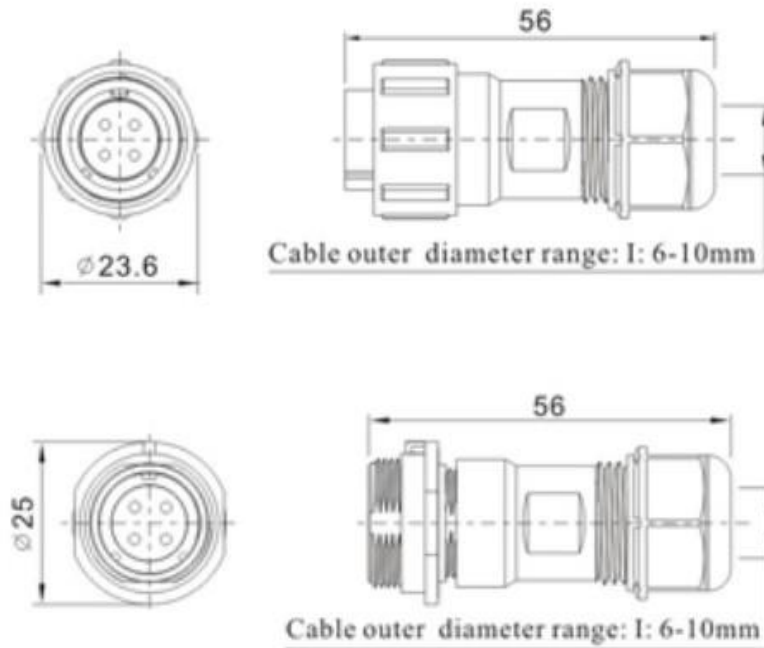

## Quality Standards

