

Plug AM-TOP® - Part no. 282

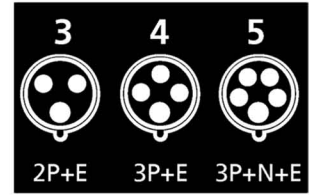

- screw terminals
- single part body
- cable gland and sealing
- strain relief and protection against kinking

Protection type IP 67
 Ampere 16A
 Poles 4p
 Voltage 400V
 Hertz 50-60Hz
 Earth position 6h
 Contact standard
 Connection technology Screw terminals

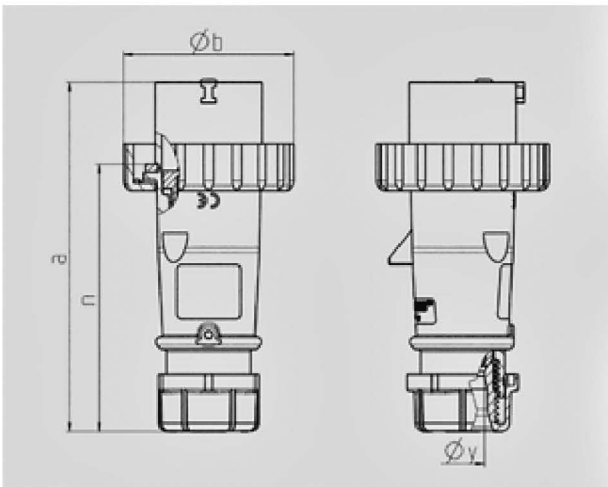

Drawing	Amp.	16			32		
		3	4	5	3	4	5
2 MB 218	Poles						
Dim. in mm	a	142	144	147	186	186	180
	b	70	78	87	94	94	101
	n	109	111	114	145	145	138
	y	14,5	16	16	22	22	22
Terminal for cond. cross		1	1	1	2,5	2,5	2,5
section (mm ²) min.-max.		-2,5	-2,5	-2,5	-6	-6	-6

