



Datasheet

RS PRO 3mtr 25 Way Male to Micro 36 Way Centronics Printer Cable

Stock number: 182-8807

EN

The RSPRO 3 metre 25 way male to micro 36 way male Centronics printer cable, also known as a parallel printer cable, which has a beige PVC jack and an outer diameter of 7.5mm. The connectors have a gold flash covering to prevent corrosion.

The connector hoods are also made of beige PVC with a strain relief to prevent the jacket splitting around the boot.

Older printers have parallel connections on them which has now been replaced with USB or wireless connections.

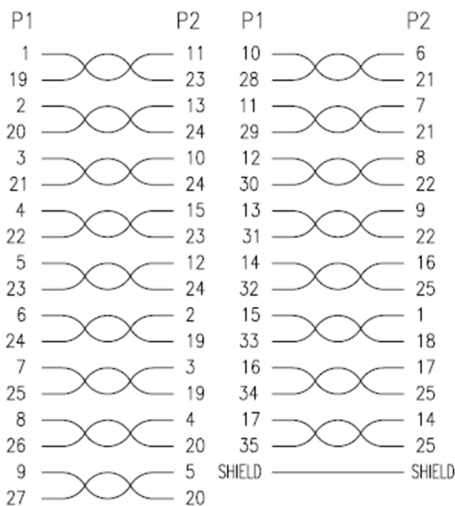
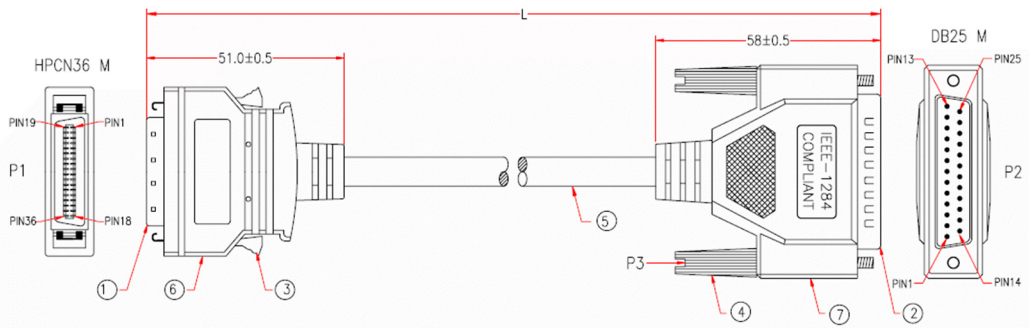

7	PVC BLACK TUBE $\phi 3.0 \times 30\text{mm}$
	COPPER FOIL 33*110mm
	MOLDED PE COLOR TRANSPARENT
	MOLDED PVC BEIGE
6	PE HOOD COLOR TRANSPARENT
	COPPER FOIL 33*110mm
	MOLDED PE COLOR TRANSPARENT
	MOLDED PVC BEIGE
5	UL20276 IEEE 1284 CABLE, 18 TWISTED PAIRS 28AWG, ALUM-MYLAR FOIL AND AMA BRAID(64%) SHIELDING WITH DRAIN WIRE, OD 7.5mm, JACKET BEIGE DRAWING No.EAAB2818P-231
4	MOLDED THUMBSCREW #4-40, LENGTH 46.5mm, BEIGE
3	LATCH
2	DB25 MALE, GOLD FLASH ON CONTACTS, BLUE INSULATOR
1	HPCN36 MALE, GOLD FLASH ON CONTACTS, BLACK INSULATOR (0.62)