



ENGLISH

Datasheet

ABS Instrument Case, Grey, 190 x 100 x 40mm

RS Stock number 219-380



Description:

Plastic enclosure, dark grey colour, made of heat resistant high-impact plastic UL-94V0. Provides protection against dust and moisture according to the standard IP54. Printed circuit boards may be horizontally or vertically mounted.

Specifications:

Colour:	Dark grey
Body Material:	ABS
External Dimensions:	190 (length) x 100 (width) x 40 (height)mm
IP Rating:	IP54
Possibility of installation of printed circuit boards:	Horizontally and vertically, racks and rails

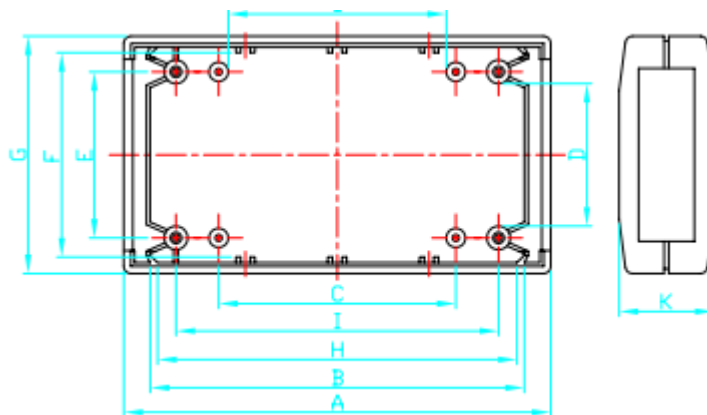
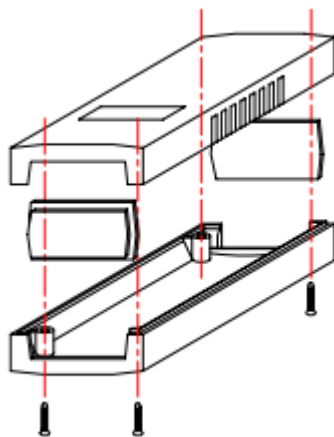

Dimensions: mm

A	190
B	180
C	150
D	65
E	75
F	83
G	100
H	176
I	168
J	140
K	40