

Datasheet

RS PRO SF20 Cable Mount Connector











Product Details

The RS Pro SF20 series is a range of precision waterproof connectors, which are sealed to IP67. Push-pull coupling enables speedy and reliable mating, and chrome-plated brass bodies combine robustness with an attractive finish. Versions are available for in-line cable to cable and for cable to panel connections. Plugs and receptacles are available with either male pins or female sockets. These products can be used for either data or power, and are for use in medical, communications and test & measurement applications.

Features and Benefits

- Push-Pull Coupling
- IP67
- Chrome-plated
- 2-12 Poles
- Cable to Cable and Cable to Panel Connections

Technical Specifications:

Number of contact	2	3	4	5	6	7	9	12
Male contact face view								
Rated current (A)	25	25	25	10	25 5	10	5	5
Contact diameter(mm)	2.25	2.5	2.5	1.5	φ2.5X4 φ1X2	1.5	1	1
Rated voltage(AC.V)	500	500	500	500	500	500	500	400
Test voltage(AC.V)1 min	1500	1500	1500	1500	1500	1500	1500	1200
Contact resistance (mΩ)	1	1	1	2.5	1 5	2.5	5	5
Termination	solder/screw	solder/screw	solder/screw	solder	solder	solder	solder	solder
Wire size (mm ² /AWG)	≤4/11	≤4/11	≤4/11	≤2/14	≤4/11 ≤0.785/18	≤2/14	≤0.785/18	≤0.785/18
Wire size for screw termination (mm ² /AWG)	≤1.5/15	≤1.5/15	≤1.5/15	/	/	/	/	/

Dimensional line drawings

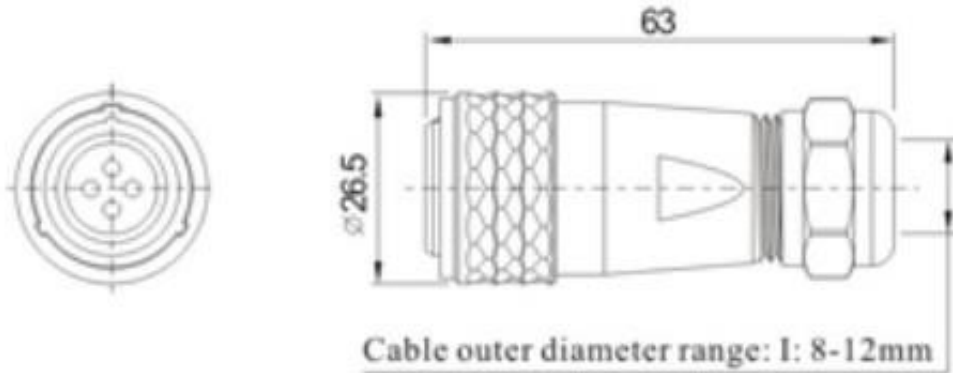

Quality Standards

