

Datasheet

RS Pro Grey 6 A Grey Plate Switch Rocker Surface 5 mm, 2 Way Screwed Matte, 1 Gang BS Standard, 240 V 86.5mm Not Illuminated

RS Stock No: **768-3523**



Product Details

RS Pro 1-gang rocker surface light switch in grey colour, is made from corrosion-resistant matte MetalClad steel for long life durability. This IP20 rated switch has a voltage rating of 240 V and current rating of 6 A. This 2-way screw termination switch has 5 mm faceplate depth. It measures 86.5 x 86.5 mm. It is suitable for industrial, commercial and workshop applications. The switch meets BS3676 standards.

Features and Benefits

- Made from mild steel
- Suitable for industrial, commercial and workshop applications
- IP20 rated

**Specifications:**

Colour Shade	Grey
Colour	Grey
Current Rating	6 A
Faceplate Depth	5 mm
Faceplate Fixing	Screwed
Finish	Matte
Fixing Standard	BS Standard
Height	22.97 mm
Illumination	Not Illuminated
IP Rating	IP20
Length	86.5 mm
Material	Metalclad Steel
Minimum Box Depth	25 mm
Mount Type	Surface
Number of Gangs	1
Number of Poles	1
Number of Ways	2
Standards Met	BS3676; ASTA Approved
Switch Type	Rocker
Termination Type	Screw
Voltage Rating	240 V
Width	86.5 mm

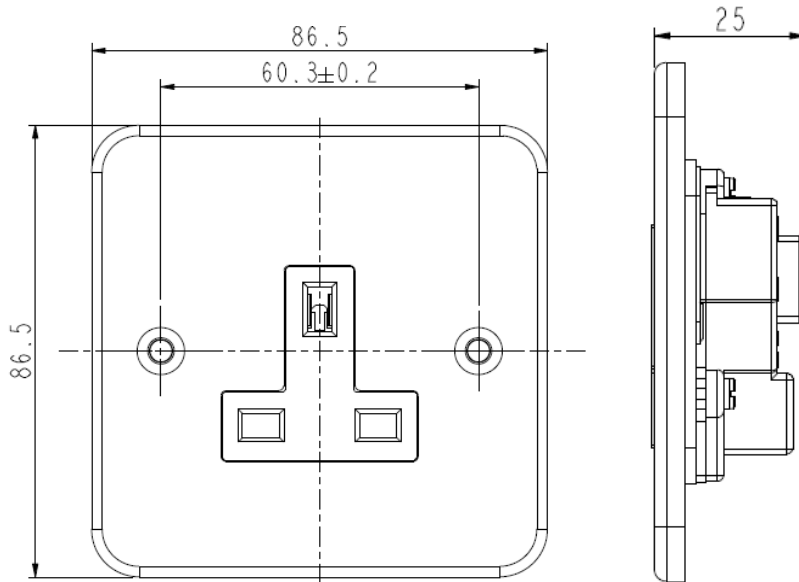

13A METALCLAD SINGLE SOCKET RS Stock No.: 768-3501

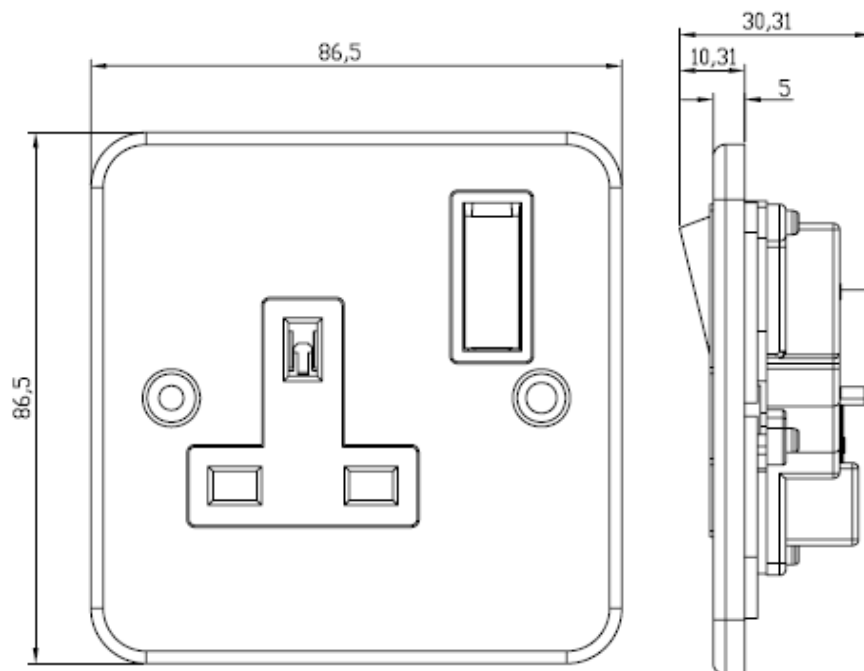

13A METALCLAD SINGLE SWITCHED SOCKET, WHITE INSERT RS Stock No.: 768-3504

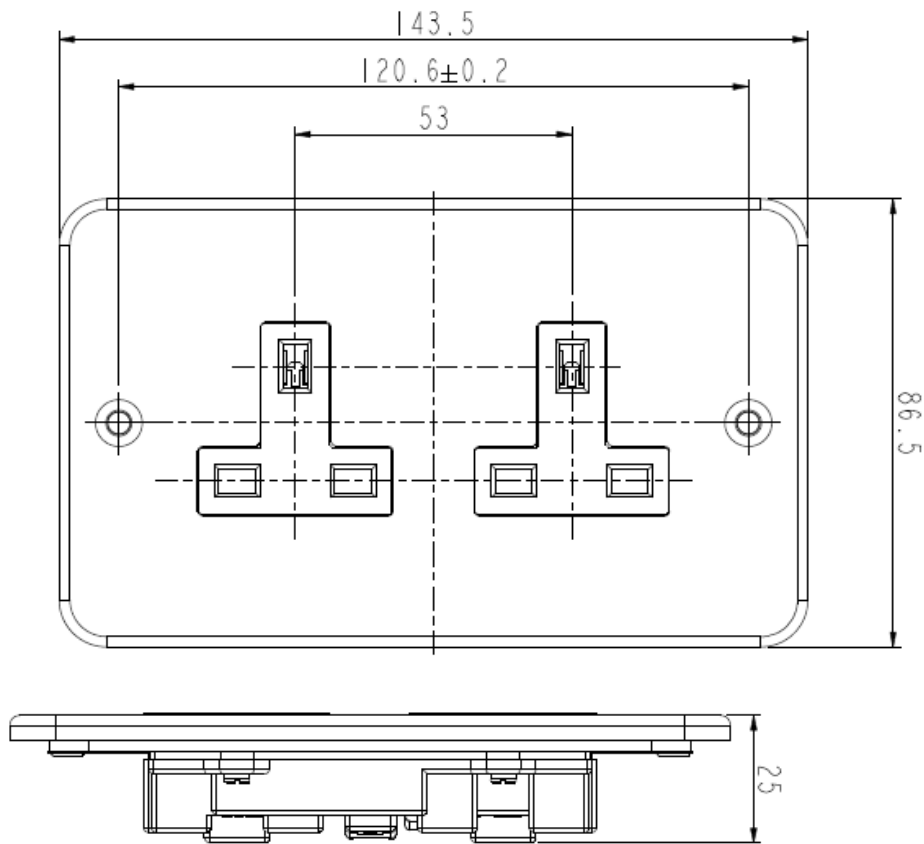

13A METALCLAD TWIN SOCKET RS Stock No.: 768-3508

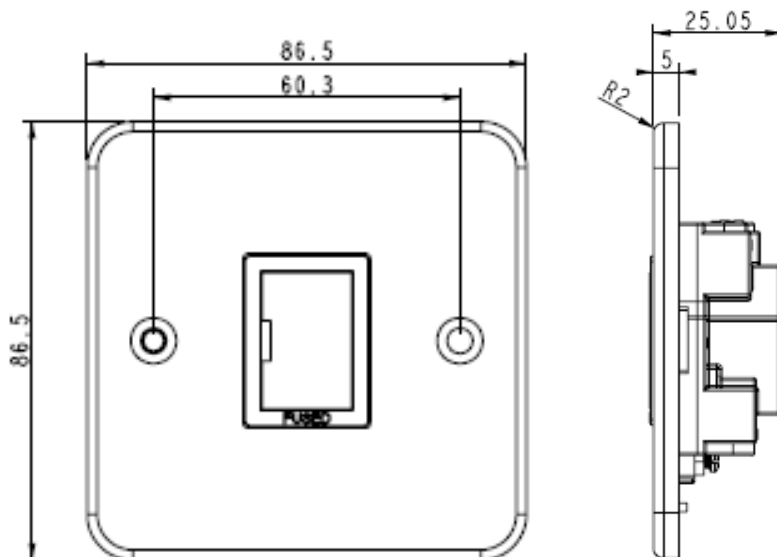

13A METALCLAD FUSED SPUR UNIT RS Stock No.: 768-3510

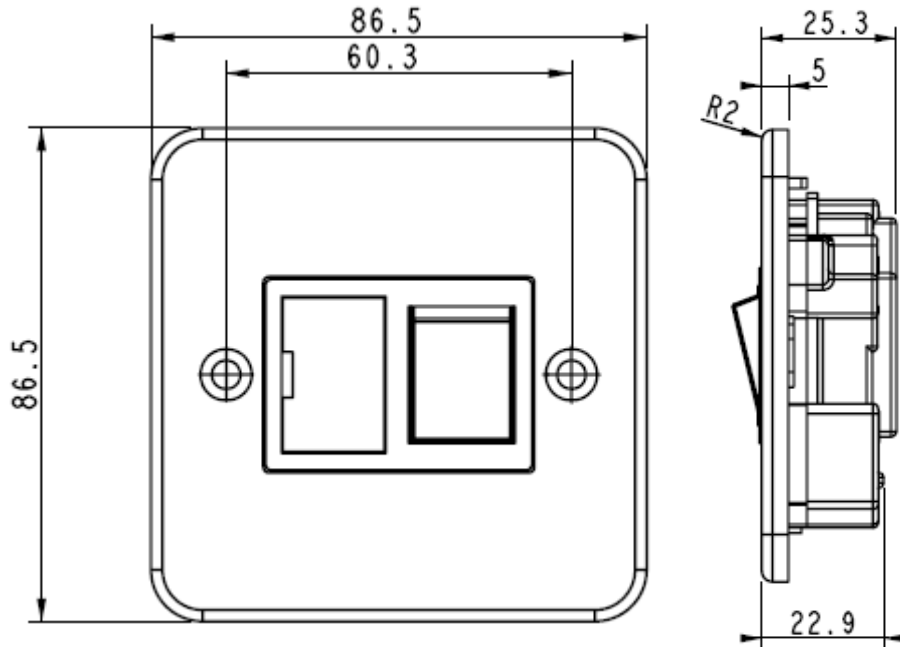

13A METALCLAD FUSED & SWITCHED DP SPUR RS Stock No.: 768-3514

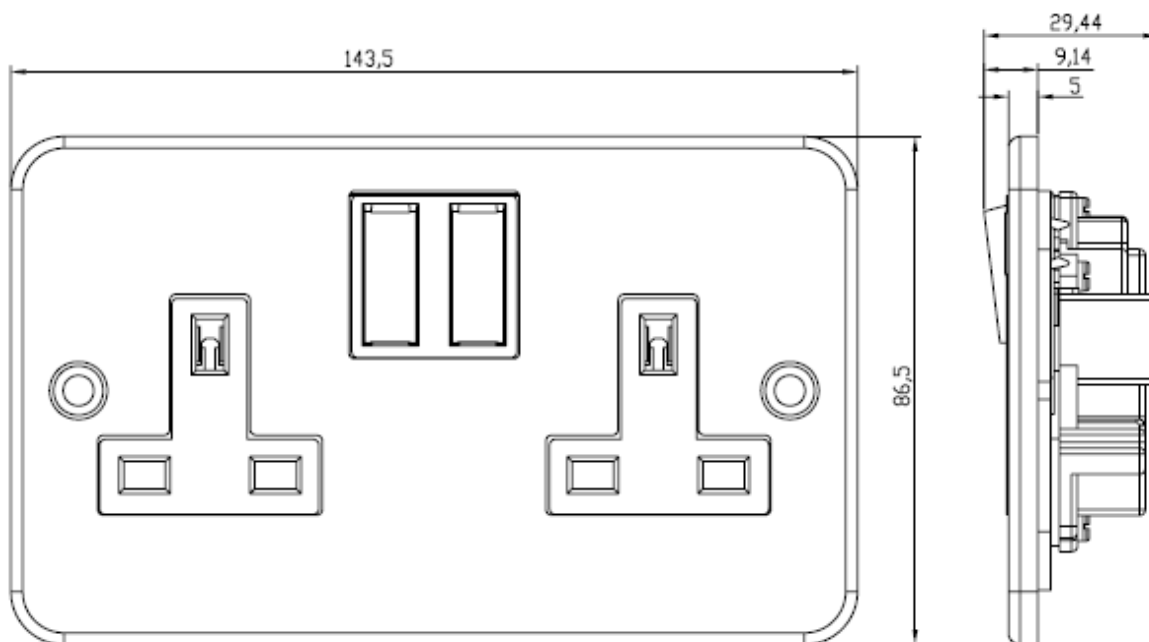

13A METALCLAD TWIN SWITCHED SOCKET RS Stock No: 768-3517

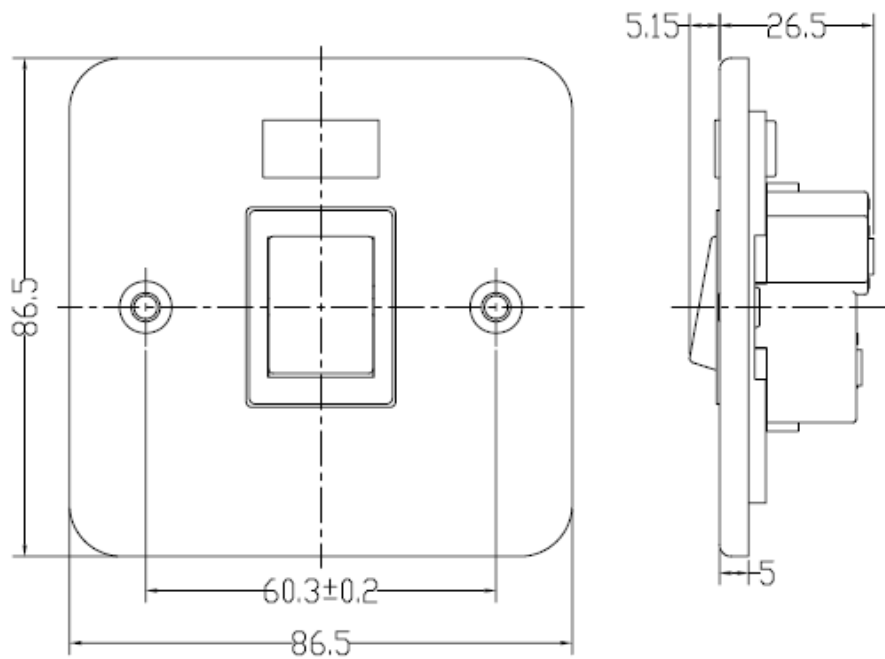

20A DP METALCLAD SWITCH WITH NEON RS Stock No.: 768-3520

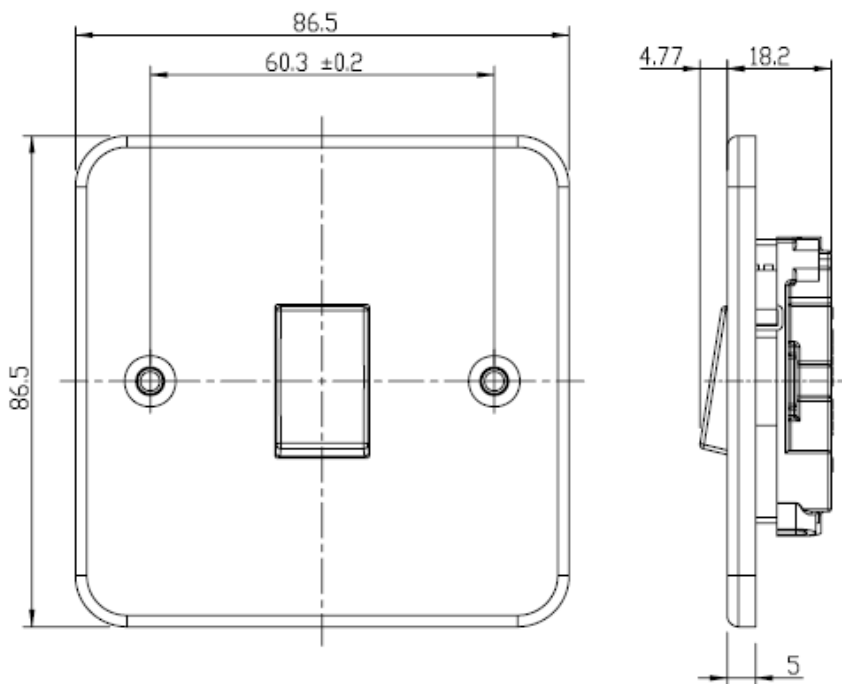

1 GANG METALCLAD SWITCH RS Stock No.: 768-3523

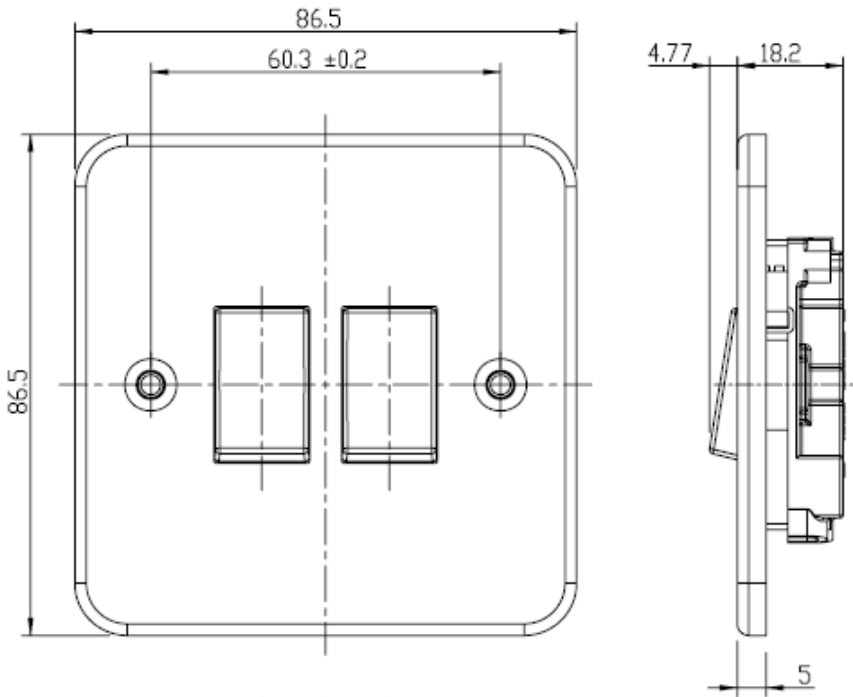

2 GANG METALCLAD SWITCH RS Stock No.: 768-3526

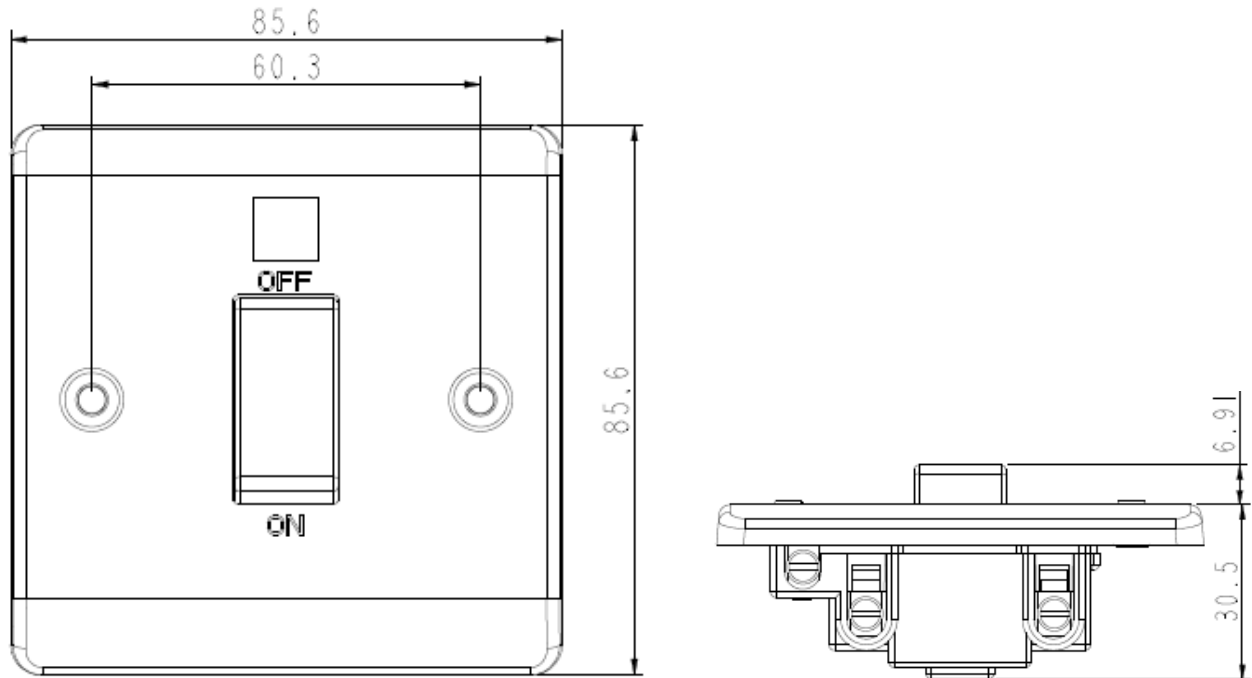

45A DP METALCLAD SWITCH WITH NEON RS Stock No.: 768-3539