

Plug AM-TOP® - Part no. 252

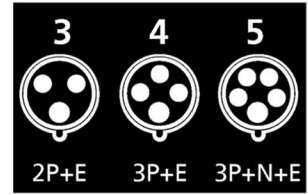

- screw terminals
- single part body
- cable gland and sealing
- strain relief and protection against kinking

Protection type IP 44
 Ampere 16A
 Poles 4p
 Voltage 400V
 Hertz 50-60Hz
 Earth position 6h
 Contact standard
 Connection technology Screw terminals

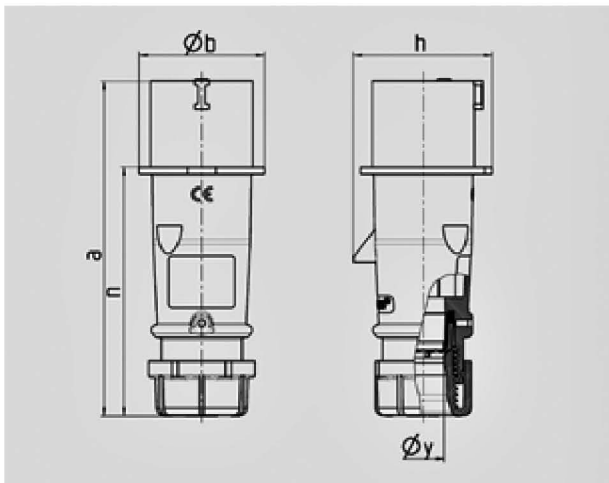

Drawing	Amp.	16			32		
		3	4	5	3	4	5
2 MB 217	Poles						
Dim. in mm	a	142	147	147	186	186	180
	b	53	59	67	70	70	77
	h	59	69,4	76	81	81	89,5
	n	105,2	110,5	110,5	141	141	135
	y	14,5	16	16	22	22	22
Terminal for cond. cross		1	1	1	2,5	2,5	2,5
section (mm²) min.-max.		-2,5	-2,5	-2,5	-6	-6	-6

