



## GaAs pHEMT MMIC LOW NOISE AMPLIFIER, 7.5 - 26.5 GHz

### Typical Applications

This HMC962LC4 is ideal for:

- Point-to-Point Radios
- Point-to-Multi-Point Radios
- Military & Space
- Test Instrumentation

### Features

- Low Noise Figure: 2.5 dB
- Gain: 13 dB
- P1dB Output Power: 13 dBm
- Single Supply Voltage: +3.5V @ 70mA
- Output IP3: +23 dBm
- 50 Ohm matched Input/Output
- 24 Lead 4x4 mm SMT Package: 16mm<sup>2</sup>

### Functional Diagram

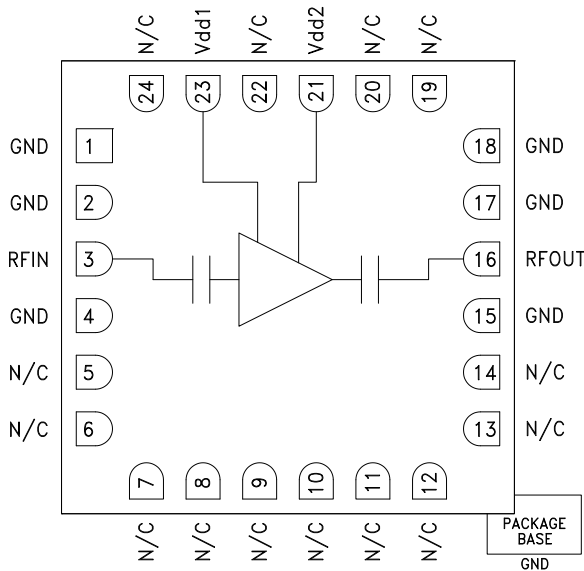

### General Description

The HMC962LC4 is a self-biased GaAs MMIC Low Noise Amplifier housed in a leadless 4x4 mm ceramic surface mount package. The amplifier operates between 7.5 and 26.5 GHz, providing 13 dB of small signal gain, 2.5 dB noise figure, and output IP3 of +23 dBm, while requiring only 70 mA from a +3.5 V supply. The P1dB output power of +13 dBm enables the LNA to function as a LO driver for balanced, I/Q or image reject mixers. The HMC962LC4 also features I/Os that are DC blocked and internally matched to 50 Ohms, making it ideal for high capacity microwave radios and VSAT applications.

### Electrical Specifications, $T_A = +25^\circ\text{C}$ , $V_{dd1} = V_{dd2} = +3.5\text{V}$ , $I_{dd} = 70\text{ mA}$

Parameter	Min.	Typ.	Max.	Min.	Typ.	Max.	Min.	Typ.	Max.	Units
Frequency Range	7.5 - 10			10 - 24			24 - 26.5			GHz
Gain	10	12		10	13		8	10		dB
Gain Variation over Temperature		0.027			0.024			0.024		dB / °C
Noise Figure [1]		2.5	3.7		2.5	3		2.7	3.7	dB
Input Return Loss		13			10			7		dB
Output Return Loss		10			12			11		dB
Output Power for 1 dB Compression		10			12			13		dBm
Saturated Output Power (P <sub>sat</sub> )		14			15			15		dBm
Output Third Order Intercept (IP3)		22			23			25		dBm
Supply Current (I <sub>dd</sub> ) (V <sub>dd</sub> = 3.5V, V <sub>gg1</sub> = V <sub>gg2</sub> = Open)		70	95		70	95		70	95	mA

[1] Board loss subtracted out.



**GaAs pHEMT MMIC LOW NOISE AMPLIFIER, 7.5 - 26.5 GHz**

**Broadband Gain & Return Loss**

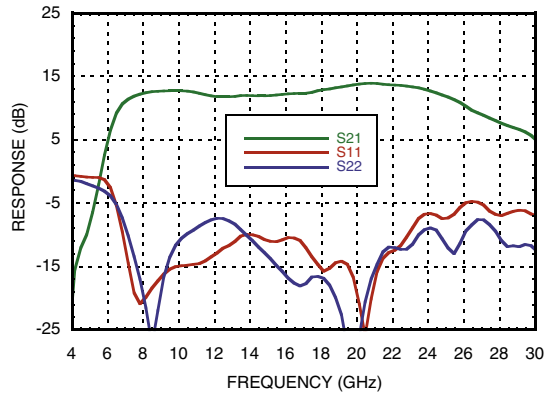

**Gain vs. Temperature**

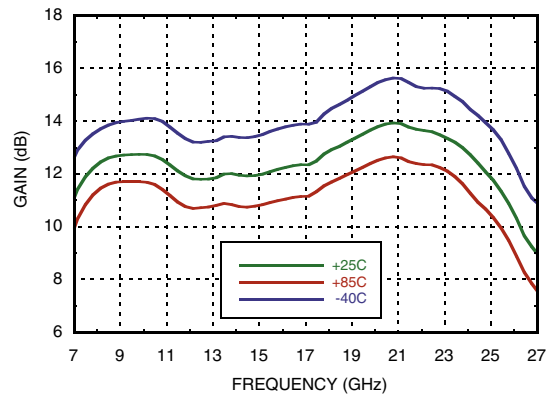

**Input Return Loss vs. Temperature**

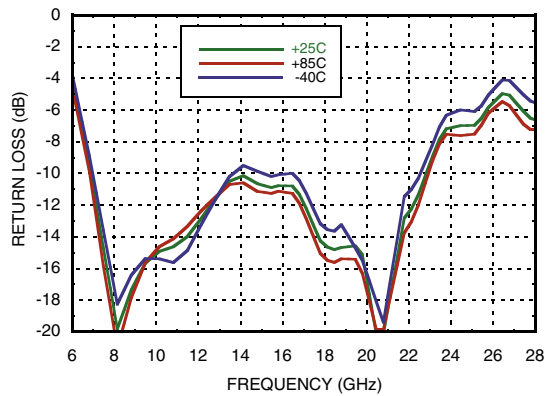

**Output Return Loss vs. Temperature**

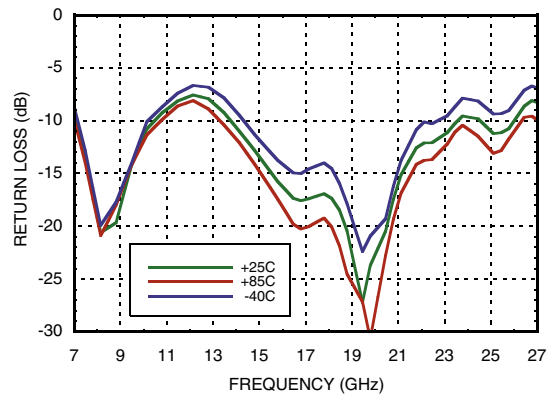

**Noise Figure vs. Temperature [1]**

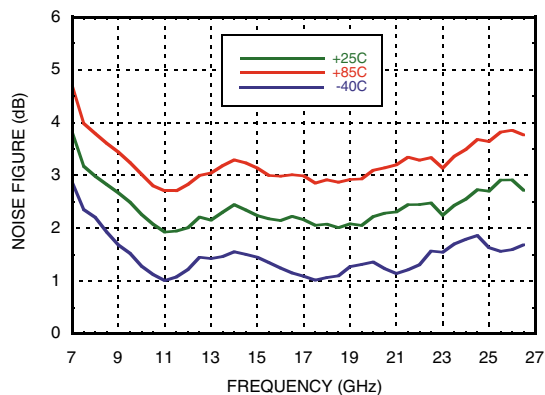

**Output IP3 vs. Temperature**

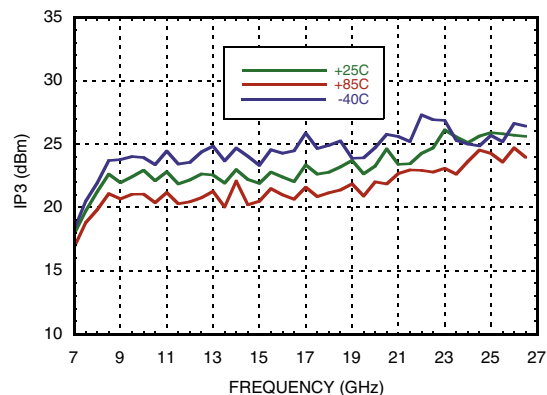

[1] Board loss subtracted out.



## GaAs pHEMT MMIC LOW NOISE AMPLIFIER, 7.5 - 26.5 GHz

AMPLIFIERS - LOW NOISE - SMT

**P1dB vs. Temperature**

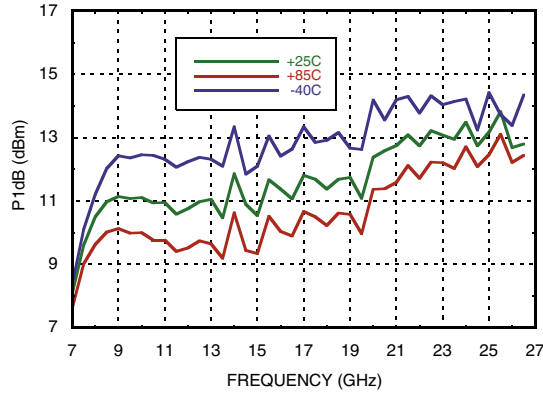

**Psat vs. Temperature**

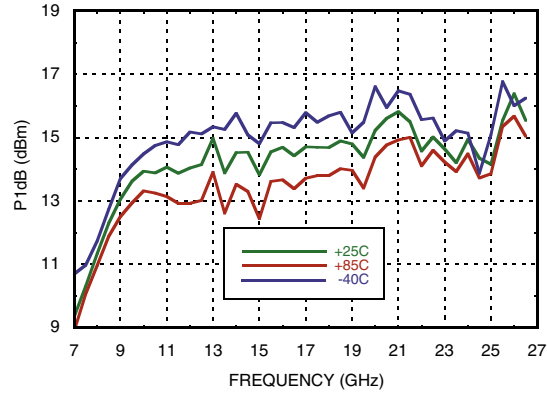

**Reverse Isolation vs. Temperature**

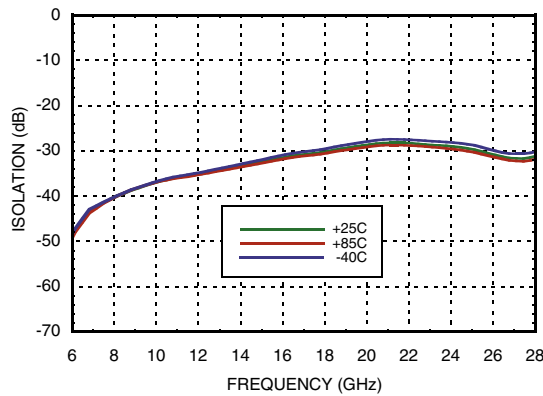

**Power Compression @ 10 GHz**

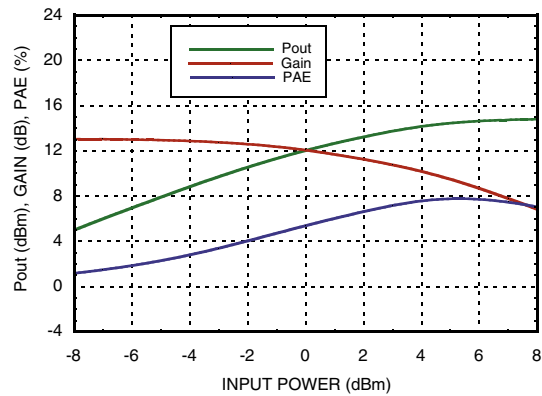

**Power Compression @ 17 GHz**

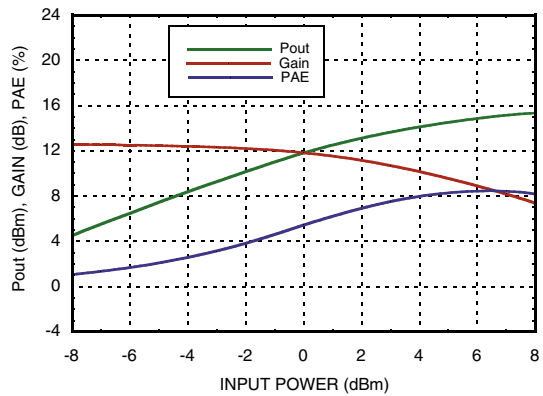

**Power Compression @ 24 GHz**

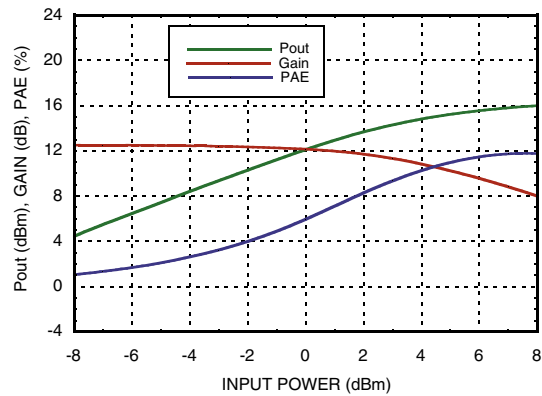

## GaAs pHEMT MMIC LOW NOISE AMPLIFIER, 7.5 - 26.5 GHz

### Current vs. Input Power @ 17 GHz

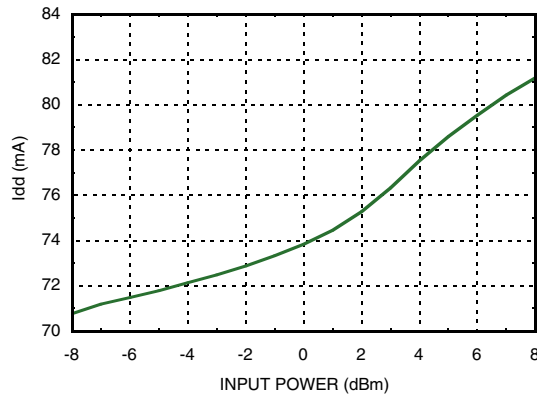

### Absolute Maximum Ratings

Drain Bias Voltage	+4V
RF Input Power	+10 dBm
Channel Temperature	150 °C
Continuous Pdiss (T = 85 °C) (derate 5.97 mW/°C above 85 °C)	0.39 W
Thermal Resistance (Channel to ground paddle)	167.6 °C/W
Storage Temperature	-65 to +150 °C
Operating Temperature	-40 to +85 °C
ESD Sensitivity (HBM)	Class 1A



ELECTROSTATIC SENSITIVE DEVICE  
OBSERVE HANDLING PRECAUTIONS

### Outline Drawing

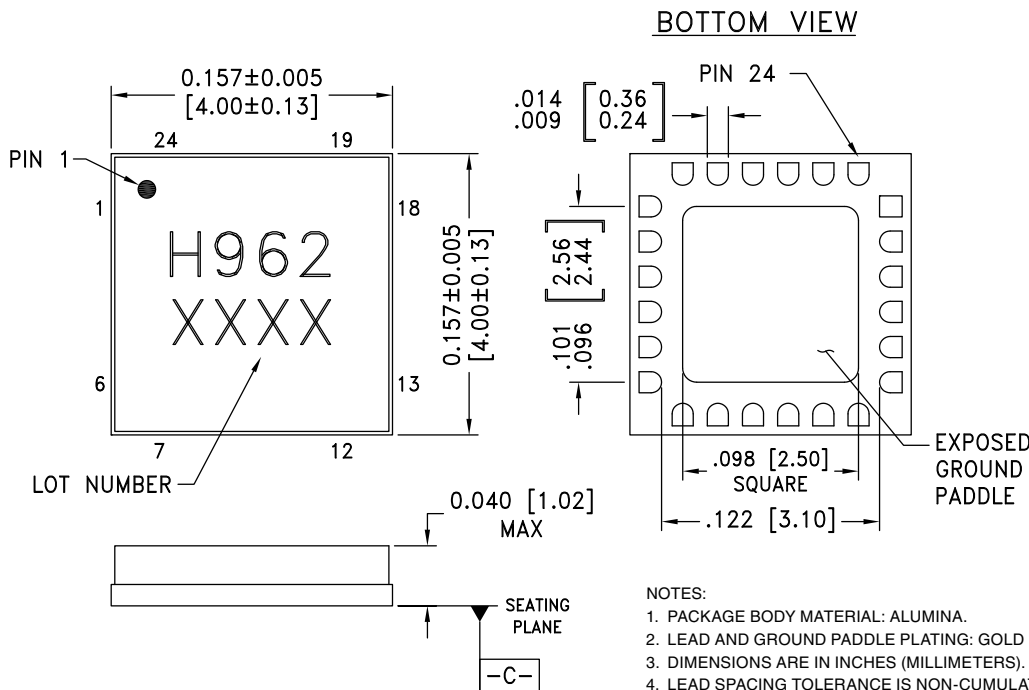

#### NOTES:

1. PACKAGE BODY MATERIAL: ALUMINA.
2. LEAD AND GROUND PADDLE PLATING: GOLD FLASH OVER NICKEL.
3. DIMENSIONS ARE IN INCHES (MILLIMETERS).
4. LEAD SPACING TOLERANCE IS NON-CUMULATIVE.
5. PACKAGE WARP SHALL NOT EXCEED 0.05MM DATUM -C-
6. ALL GROUND LEADS AND GROUND PADDLE MUST BE SOLDERED TO PCB RF GROUND.



## GaAs pHEMT MMIC LOW NOISE AMPLIFIER, 7.5 - 26.5 GHz

### Pin Descriptions

Pin Number	Function	Description	Interface Schematic
1, 2, 4, 15, 17, 18	GND	These pins and package bottom must be connected to RF/DC ground.	
3	RFIN	This pin AC coupled and matched to 50 Ohms	
5 - 14, 19, 20, 22, 24	N/C	No connection necessary. These pins may be connected to RF/DC ground. Performance will not be affected.	
16	RFOUT	This pin AC coupled and matched to 50 Ohms	
21, 23	Vdd1, Vdd2	Power supply voltages for the amplifier. Bypass capacitors are required. See application circuit herein.	

### Application Circuit

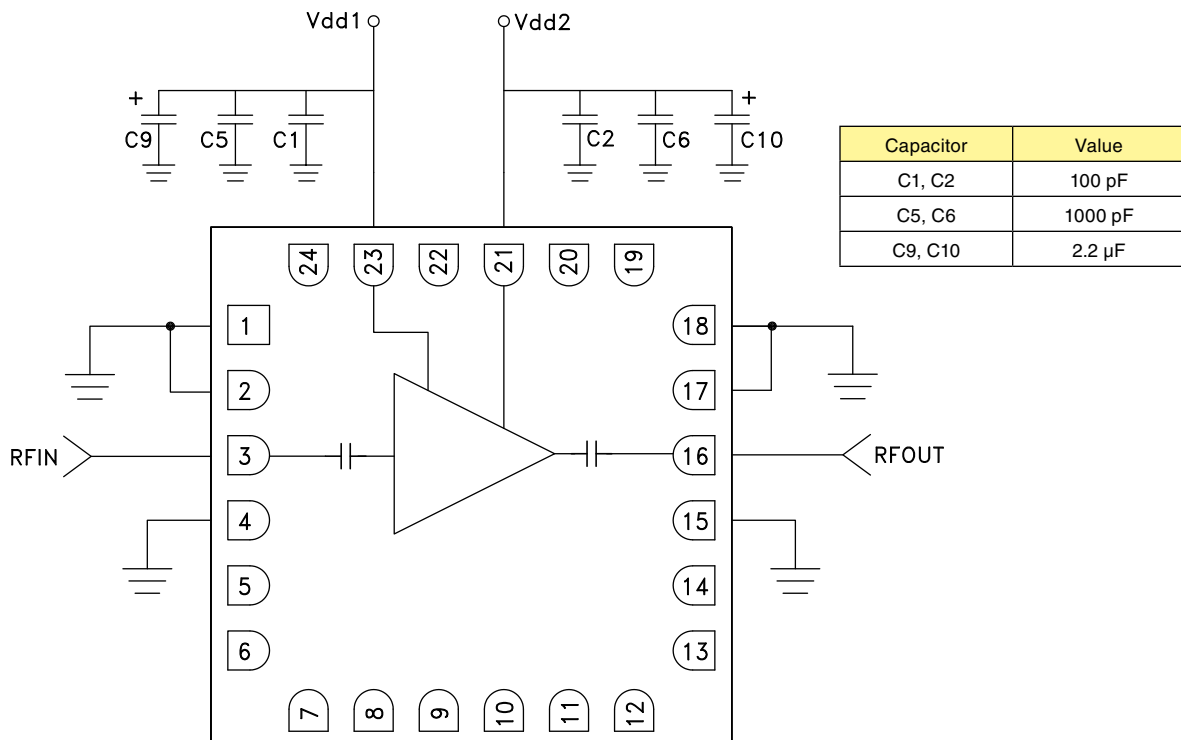

### Evaluation PCB

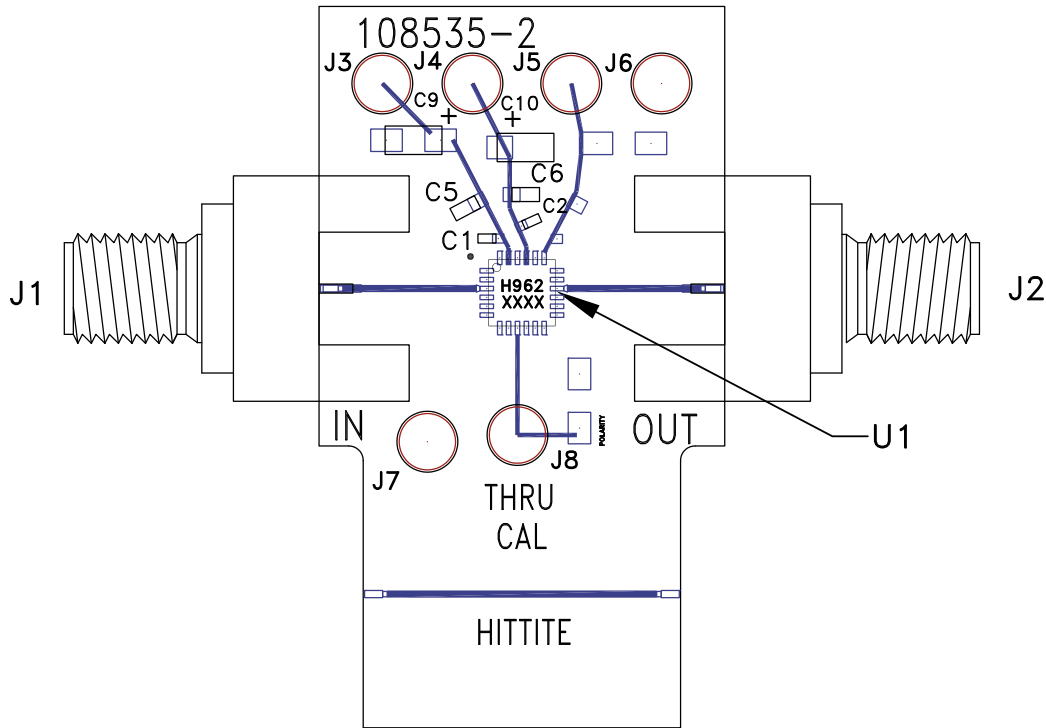

### List of Material for Evaluation PCB EVAL01-HMC962LC4 [1]

Item	Description
J1, J2	2.92 mm Connectors
J3 - J8	DC Pin
C1, C2	100 pF Capacitor, 0402 Pkg.
C5, C6	1000 pF Capacitor, 0603 Pkg.
C9, C10	2.2 μF Capacitor, Tantalum
U1	HMC962LC4 Amplifier
PCB [2]	108535 Evaluation PCB

[1] Reference this number when ordering complete evaluation PCB

[2] Circuit Board Material: Rogers 4350 or Arlon 25FR

The circuit board used in this application should use RF circuit design techniques. Signal lines should have 50 Ohm impedance while the package ground leads and exposed paddle should be connected directly to the ground plane similar to that shown. A sufficient number of via holes should be used to connect the top and bottom ground planes. The evaluation board should be mounted to an appropriate heat sink. The evaluation circuit board shown is available from Hittite upon request.