

# ATS22D62Q

soft starter for asynchronous motor, Altistart 22,  
control 230V, 230 to 440V, 15 to 30kW



## Main

Range of product	Altistart 22
Product or component type	Soft starter
Product destination	Asynchronous motors
Product specific application	Pumps and fans
Component name	ATS22
Network number of phases	3 phases
[Us] rated supply voltage	230...440 V - 15...10 %
Motor power kW	15 KW 230 V 30 KW 400 V 30 kW 440 V
Factory setting current	57 A
Power dissipation in W	59 W for standard applications
Utilisation category	AC-53A
Type of start	Start with torque control (current limited to 3.5 In)
IcL starter rating	62 A for connection in the motor supply line for standard applications
IP degree of protection	IP20

## Complementary

Assembly style	With heat sink
Function available	Internal bypass
Supply voltage limits	195...484 V
Supply frequency	50...60 Hz - 10...10 %
Network frequency	45...66 Hz
Device connection	To the motor delta terminals In the motor supply line
[Uc] control circuit voltage	230 V - 15...10 % 50/60 Hz
Control circuit consumption	20 W
Discrete output number	2
Discrete output type	Relay outputs R1 230 V running, alarm, trip, stopped, not stopped, starting, ready C/O Relay outputs R2 230 V running, alarm, trip, stopped, not stopped, starting, ready C/O
Minimum switching current	100 mA at 12 V DC (relay outputs)
Maximum switching current	5 A 250 V AC resistive 1 relay outputs 5 A 30 V DC resistive 1 relay outputs 2 A 250 V AC inductive 0.4 20 ms relay outputs 2 A 30 V DC inductive 7 ms relay outputs
Discrete input number	3
Discrete input type	(LI1, LI2, LI3) logic, 5 mA 4.3 kOhm
Discrete input voltage	24 V <= 30 V
Discrete input logic	Positive logic LI1, LI2, LI3 at State 0: < 5 V and <= 2 mA at State 1: > 11 V, >= 5 mA
Output current	0.4...1 Icl adjustable
PTC probe input	750 Ohm
Communication port protocol	Modbus
Connector type	1 RJ45
Communication data link	Serial

The information provided in this documentation contains general descriptions and/or technical characteristics of the performance of the products contained herein. This documentation is not intended as a substitute for and is not to be used for determining suitability or reliability of these products for specific user applications. It is the duty of any such user or integrator to perform the appropriate and complete risk analysis, evaluation and testing of the products with respect to the relevant specific application or use thereof. Neither Schneider Electric Industries SAS nor any of its affiliates or subsidiaries shall be responsible or liable for misuse of the information contained herein.

Physical interface	RS485 multidrop
Transmission rate	4800, 9600 or 19200 bps
Installed device	31
Protection type	Phase failure: line Thermal protection: motor Thermal protection: starter
Marking	CE
Type of cooling	Forced convection
Operating position	Vertical +/- 10 degree
Height	295 mm
Width	145 mm
Depth	207 mm
Net weight	12 kg
Motor power range AC-3	15...25 kW at 200...240 V 3 phases 30...50 kW at 380...440 V 3 phases
Motor starter type	Soft starter

## Environment

Electromagnetic compatibility	Conducted and radiated emissions level A conforming to IEC 60947-4-2 Damped oscillating waves level 3 conforming to IEC 61000-4-12 Electrostatic discharge level 3 conforming to IEC 61000-4-2 Immunity to electrical transients level 4 conforming to IEC 61000-4-4 Immunity to radiated radio-electrical interference level 3 conforming to IEC 61000-4-3 Voltage/current impulse level 3 conforming to IEC 61000-4-5
Standards	IEC 60947-4-2
Product certifications	C-Tick[RETURN]CCC[RETURN]UL[RETURN]CSA[RETURN]GOST
Vibration resistance	1 gn (f= 13...200 Hz) conforming to IEC 60068-2-6 1.5 mm (f= 2...13 Hz) conforming to IEC 60068-2-6
Shock resistance	15 gn for 11 ms conforming to IEC 60068-2-27
Noise level	45 dB
Pollution degree	Level 2 conforming to IEC 60664-1
Relative humidity	0...95 % without condensation or dripping water conforming to IEC 60068-2-3
Ambient air temperature for operation	-10...40 °C (without derating) 40...60 °C (with current derating 2.2 % per °C)
Ambient air temperature for storage	-25...70 °C
Operating altitude	<= 1000 m without derating > 1000...< 2000 m with current derating of 2.2 % per additional 100 m

## Packing Units

Unit Type of Package 1	PCE
Number of Units in Package 1	1
Package 1 Height	31.0 cm
Package 1 Width	23.5 cm
Package 1 Length	36.0 cm
Package 1 Weight	8.262 kg
Unit Type of Package 2	P06
Number of Units in Package 2	6
Package 2 Height	73.5 cm
Package 2 Width	80.0 cm
Package 2 Length	60.0 cm
Package 2 Weight	64.0 kg

## Offer Sustainability

REACH Regulation	<a href="#">REACH Declaration</a>
EU RoHS Directive	Pro-active compliance (Product out of EU RoHS legal scope)
Mercury free	Yes
China RoHS Regulation	<a href="#">China RoHS Declaration</a>
RoHS exemption information	<a href="#">Yes</a>
WEEE	The product must be disposed on European Union markets following specific waste collection and never end up in rubbish bins

## Contractual warranty

Warranty	18 months
----------	-----------

Frame Size B

Dimensions

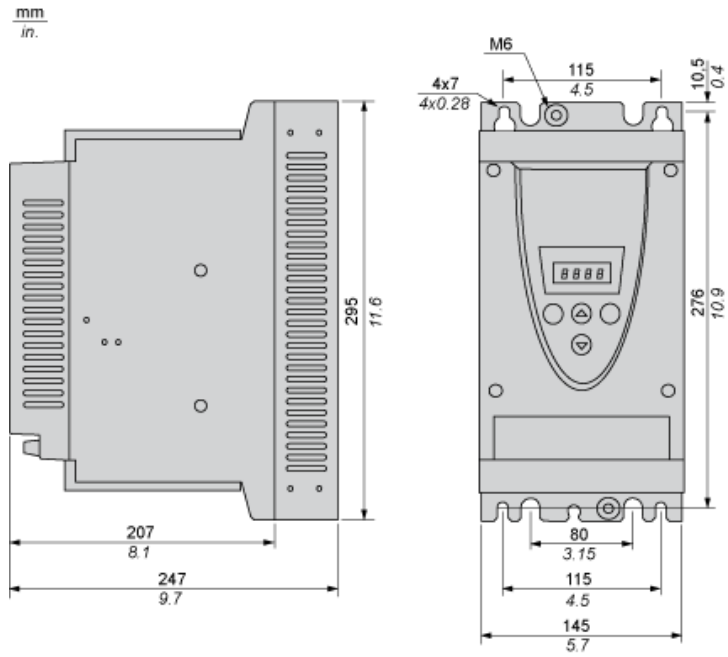

## Precautions

### Standards

The Altistart 22 soft starter is compliant with pollution Degree 2 as defined in NEMA ICS1-1 or IEC 60664-1.

For environment pollution degree 3, install the Altistart 22 soft starter inside a cabinet type 12 or IP54.

### **⚠ DANGER**

HAZARD OF ELECTRIC SHOCK, EXPLOSION, OR ARC FLASH

ATS22 soft starters are open devices and must be mounted in a suitable enclosure.

Failure to follow these instructions will result in death or serious injury.

### Air Circulation

Leave sufficient free space to help the air required for cooling purposes to circulate from the bottom to the top of the unit.

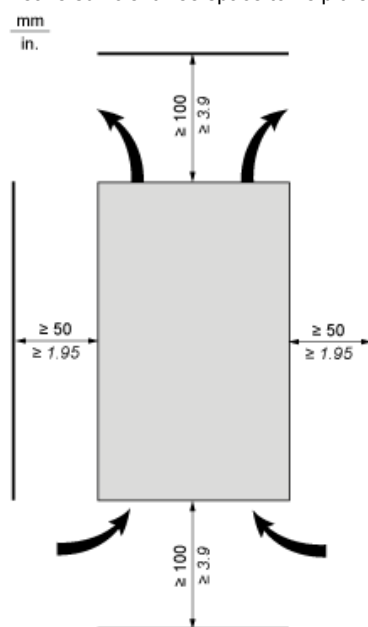

### Overheating

To avoid the soft starter to overheat, respect the following recommendations:

- Mount the Altistart 22 Soft Starter within  $\pm 10^\circ$  of vertical.
- Do not locate the Altistart 22 Soft Starter near heat radiating elements.
- Electrical current through the Altistart 22 Soft Starter will result in heat losses that must be dissipated into the ambient air immediately surrounding the soft starter. To help prevent a thermal fault, provide sufficient enclosure cooling and/or ventilation to limit the ambient temperature around the soft starter.
- If several soft starters are installed in a control panel, arrange them in a row. Do not stack soft starters. Heat generated from the bottom soft starter can adversely affect the ambient temperature around the top soft starter.

### Mounting

## Connection Between the Fan and the Altistart 22 Soft Starter



- 1 Altistart 22 Soft Starter
- 2 Fan

## Wall mounted or Floor-standing Enclosure with IP 23 Degree of protection

---

### Introduction

To help proper air circulation in the soft starter, grilles and forced ventilation can be installed.

### Ventilation Grilles

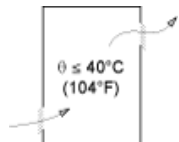

### Forced Ventilation Unit

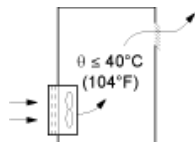

Power Terminal

Cage Style



1 Ground connection

Power connections, minimum and maximum wiring capabilities, tightening torque

			IEC cable	UL cable
Power supply and output to motor	Size/gauge	min	4 mm (a)	10 AWG (a)
max	50 mm	1/0 AWG		
Tightening torque	min	8 N.m	70 lb.in	
max	8 N.m	70 lb.in		
Strip length		15 mm	0.6 in.	

Power connections, minimum required wiring section

IEC cable mm <sup>2</sup> (Cu 70°C/158°F) (1)	UL cable AWG (Cu 75°C/167°F) (1)
16	4

230 Vac control, logic Inputs (LI) 24 Vdc, 3-wire control

With Line Contactor, Freewheel or Controlled Stop

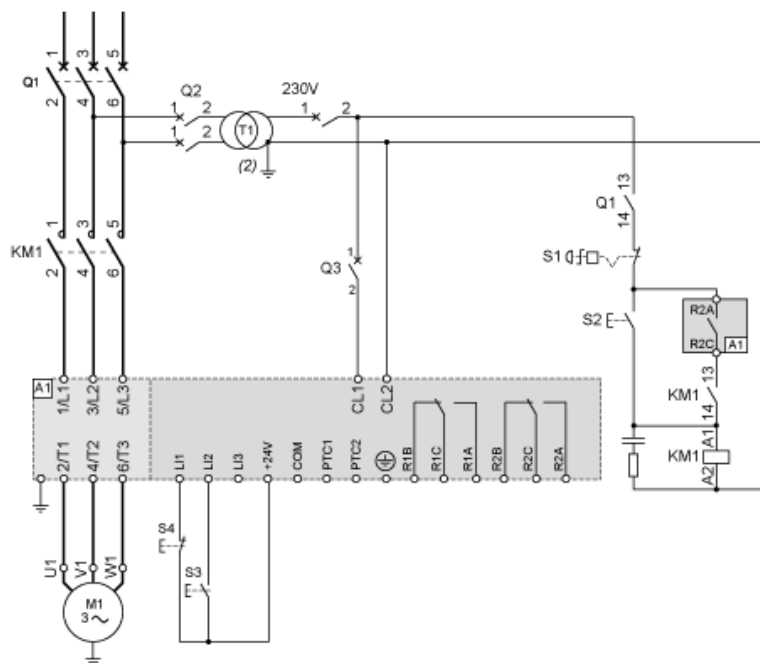

230 Vac control, logic Inputs (LI) 24 Vdc, 2-wire control, freewheel stop

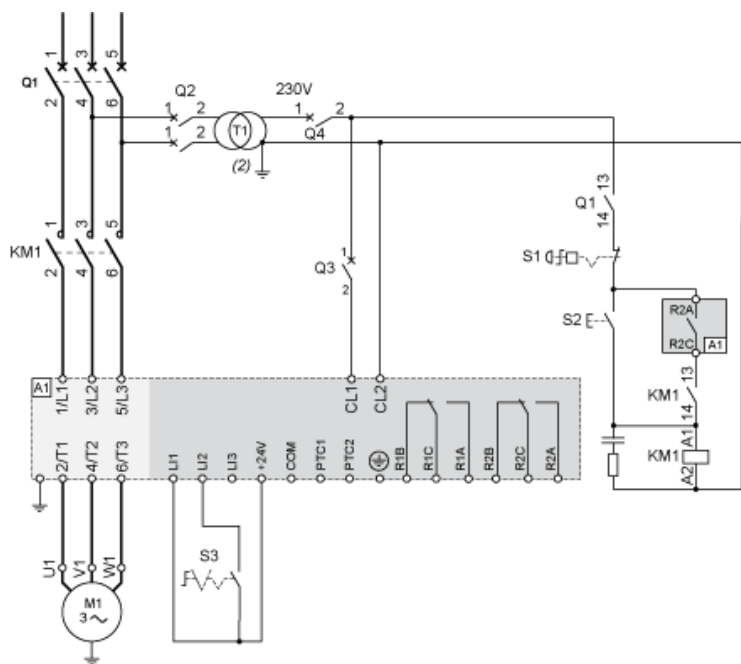

Connection in the motor delta winding in series with each winding

Wiring

ATS22 soft starters connected to motors with the delta connections can be inserted in series in the motor windings.

The following wiring requires particular attention. It is documented in the Altistart 22 Soft start - soft stop unit user manual. Please contact Schneider Electric commercial organisation for further informations.





### Example

A 400 V - 110 kW motor with a line current of 195 A (nominal current for the delta connection). The current in each winding is equal to  $195/1.5$  or 130 A. The rating is determined by selecting the soft starter with a permanent nominal current (ICL) just above this current.

Motor Thermal Protection - Cold Curves

Curves



- A Class 10
- B Class 20
- C Class 30

Trip time for a Standard Application (Class 10)

3.5 In
32 s

Trip time for a Severe Application (Class 20)

3.5 In
63 s

Trip time for a Severe Application (Class 30)

3.5 In
95 s

Curves

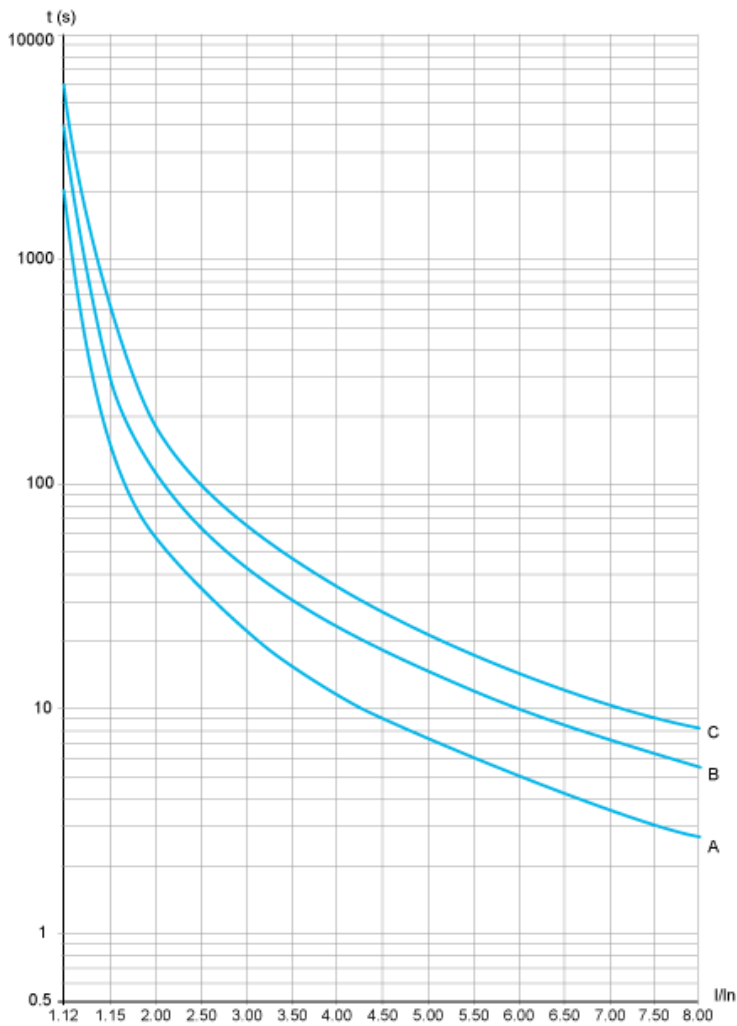

- A Class 10
- B Class 20
- C Class 30

Trip time for a Standard Application (Class 10)

3.5 In
16 s

Trip time for a Severe Application (Class 20)

3.5 In
32 s

Trip time for a Severe Application (Class 30)

3.5 In
48 s