

FEATURES

Low drift 2.5 V reference: 2 ppm/°C typical
Tiny package: 3 mm × 3 mm, 16-lead LFCSP
Total unadjusted error (TUE): ±0.1% of FSR maximum

Offset error: ±1.5 mV maximum
Gain error: ±0.1% of FSR maximum
High drive capability: 20 mA, 0.5 V from supply rails
User selectable gain of 1 or 2 (GAIN pin)
Reset to zero scale or midscale (RSTSEL pin)
1.8 V logic compatibility
50 MHz SPI with readback or daisy chain
Low glitch: 0.5 nV-sec
Robust 4 kV HBM and 1.5 kV FICDM ESD ratings
Low power: 3.3 mW at 3 V
2.7 V to 5.5 V power supply
–40°C to +105°C temperature range

APPLICATIONS

Optical transceivers
 Base station power amplifiers
 Process control (PLC I/O cards)
 Industrial automation
 Data acquisition systems

GENERAL DESCRIPTION

The **AD5313R**, a member of the *nano*DAC[®] family, is a low power, dual, 10-bit buffered voltage output digital-to-analog converter (DAC). The device includes a 2.5 V, 2 ppm/°C internal reference (enabled by default) and a gain select pin giving a full-scale output of 2.5 V (gain = 1) or 5 V (gain = 2). The **AD5313R** operates from a single 2.7 V to 5.5 V supply, is guaranteed monotonic by design, and exhibits less than 0.1% FSR gain error and 1.5 mV offset error performance. The device is available in a 3 mm × 3 mm LFCSP package and a TSSOP package.

The **AD5313R** also incorporates a power-on reset circuit and a RSTSEL pin that ensures that the DAC outputs power up to zero scale or midscale and remain there until a valid write occurs. The part contains a per channel power-down feature that reduces the current consumption of the device to 4 μA at 3 V while in power-down mode.

The **AD5313R** employs a versatile serial peripheral interface (SPI) that operates at clock rates up to 50 MHz, and the device contains a V_{LOGIC} pin that is intended for 1.8 V/3 V/5 V logic.

Rev. A

[Document Feedback](#)

Information furnished by Analog Devices is believed to be accurate and reliable. However, no responsibility is assumed by Analog Devices for its use, nor for any infringements of patents or other rights of third parties that may result from its use. Specifications subject to change without notice. No license is granted by implication or otherwise under any patent or patent rights of Analog Devices. Trademarks and registered trademarks are the property of their respective owners.

FUNCTIONAL BLOCK DIAGRAM

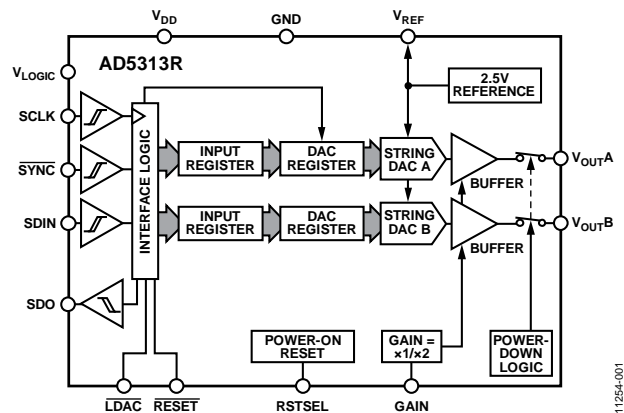

Figure 1.

Table 1. Related Devices

Interface	Reference	12-Bit	10-Bit
SPI	Internal	AD5687R	N/A
	External	AD5687	AD5313 ¹
I ² C	Internal	AD5697R	AD5338R ¹
	External	N/A	AD5338 ¹

¹ The **AD5313R** and the **AD5313** are not pin-to-pin or software compatible; likewise, the **AD5338R** and the **AD5338** are not pin-to-pin or software compatible.

PRODUCT HIGHLIGHTS

- Precision DC Performance.
 - Total unadjusted error: ±0.1% of FSR maximum
 - Offset error: ±1.5 mV maximum
 - Gain error: ±0.1% of FSR maximum
- Low Drift 2.5 V On-Chip Reference.
 - 2 ppm/°C typical temperature coefficient
 - 5 ppm/°C maximum temperature coefficient
- Two Package Options.
 - 3 mm × 3 mm, 16-lead LFCSP
 - 16-lead TSSOP

AD5313R* Product Page Quick Links

Last Content Update: 11/01/2016

[Comparable Parts](#)

View a parametric search of comparable parts

[Documentation](#)

Data Sheet

- AD5313R: Dual, 10-Bit nanoDAC with 2 ppm/°C Reference, SPI Interface Data Sheet

[Reference Materials](#)

Press

- Analog Devices' nanoDAC+™ Converters Expand Industry's Best D/A Converter Performance and Smallest Packages

[Design Resources](#)

- AD5313R Material Declaration
- PCN-PDN Information
- Quality And Reliability
- Symbols and Footprints

[Discussions](#)

View all AD5313R EngineerZone Discussions

[Sample and Buy](#)

Visit the product page to see pricing options

[Technical Support](#)

Submit a technical question or find your regional support number

TABLE OF CONTENTS

Features	1	Write and Update Commands.....	19
Applications.....	1	Daisy-Chain Operation	19
Functional Block Diagram	1	Readback Operation	20
General Description	1	Power-Down Operation	20
Product Highlights	1	Load DAC (Hardware $\overline{\text{LDAC}}$ Pin).....	21
Revision History	2	$\overline{\text{LDAC}}$ Mask Register	21
Specifications.....	3	Hardware Reset ($\overline{\text{RESET}}$)	22
AC Characteristics.....	4	Reset Select Pin (RSTSEL)	22
Timing Characteristics	5	Internal Reference Setup	22
Daisy-Chain and Readback Timing Characteristics	6	Solder Heat Reflow.....	22
Absolute Maximum Ratings.....	8	Thermal Hysteresis	23
ESD Caution.....	8	Applications Information	24
Pin Configurations and Function Descriptions	9	Microprocessor Interfacing.....	24
Typical Performance Characteristics	10	AD5313R to ADSP-BF531 Interface	24
Terminology	15	AD5313R to SPORT Interface	24
Theory of Operation	17	Layout Guidelines.....	24
Digital-to-Analog Converter (DAC)	17	Galvanically Isolated Interface	24
Transfer Function	17	Outline Dimensions	25
DAC Architecture.....	17	Ordering Guide	25
Serial Interface	18		
Standalone Operation	19		

REVISION HISTORY

2/14—Rev. 0 to Rev. A

Change to Table 2	3
Change to Table 7	9
Deleted Figure 10, Renumbered Sequentially	10
Deleted Long-Term Temperature Drift Section and Figure 45	23

2/13—Revision 0: Initial Version

SPECIFICATIONS

$V_{DD} = 2.7\text{ V to }5.5\text{ V}$; $1.8\text{ V} \leq V_{LOGIC} \leq 5.5\text{ V}$; all specifications T_{MIN} to T_{MAX} , unless otherwise noted. $R_L = 2\text{ k}\Omega$; $C_L = 200\text{ pF}$.

Table 2.

Parameter	Min	Typ	Max	Unit	Test Conditions/Comments
STATIC PERFORMANCE¹					
Resolution	10			Bits	
Relative Accuracy		± 0.12	± 0.5	LSB	
Differential Nonlinearity			± 0.5	LSB	Guaranteed monotonic by design
Zero-Code Error		0.4	1.5	mV	All 0s loaded to DAC register
Offset Error		+0.1	± 1.5	mV	
Full-Scale Error		+0.01	± 0.1	% of FSR	All 1s loaded to DAC register
Gain Error		± 0.02	± 0.1	% of FSR	
Total Unadjusted Error		± 0.01	± 0.1	% of FSR	External reference; gain = 2; TSSOP
			± 0.2	% of FSR	Internal reference; gain = 1; TSSOP
Offset Error Drift ²		± 1		$\mu\text{V}/^\circ\text{C}$	
Gain Temperature Coefficient ²		± 1		ppm	Of FSR/ $^\circ\text{C}$
DC Power Supply Rejection Ratio ²		0.15		mV/V	DAC code = midscale; $V_{DD} = 5\text{ V} \pm 10\%$
DC Crosstalk ²			± 2	μV	Due to single-channel, full-scale output change
			± 3	$\mu\text{V}/\text{mA}$	Due to load current change
			± 2	μV	Due to powering down (per channel)
OUTPUT CHARACTERISTICS²					
Output Voltage Range	0		V_{REF}	V	Gain = 1
	0		$2 \times V_{REF}$	V	Gain = 2; see Figure 28
Capacitive Load Stability		2		nF	$R_L = \infty$
		10		nF	$R_L = 1\text{ k}\Omega$
Resistive Load ³	1			k Ω	
Load Regulation		80		$\mu\text{V}/\text{mA}$	$5\text{ V} \pm 10\%$, DAC code = midscale; $-30\text{ mA} \leq I_{OUT} \leq 30\text{ mA}$
		80		$\mu\text{V}/\text{mA}$	$3\text{ V} \pm 10\%$, DAC code = midscale; $-20\text{ mA} \leq I_{OUT} \leq 20\text{ mA}$
Short-Circuit Current ⁴		40		mA	
Load Impedance at Rails ⁵		25		Ω	See Figure 28
Power-Up Time		2.5		μs	Coming out of power-down mode; $V_{DD} = 5\text{ V}$
REFERENCE OUTPUT					
Output Voltage ⁶	2.4975		2.5025	V	At ambient
Reference Temperature Coefficient ^{7,8}		2	5	ppm/ $^\circ\text{C}$	See the Terminology section
Output Impedance ²		0.04		Ω	
Output Voltage Noise ²		12		$\mu\text{V p-p}$	0.1 Hz to 10 Hz
Output Voltage Noise Density ²		240		nV/ $\sqrt{\text{Hz}}$	At ambient; $f = 10\text{ kHz}$, $C_L = 10\text{ nF}$
Load Regulation Sourcing ²		20		$\mu\text{V}/\text{mA}$	At ambient
Load Regulation Sinking ²		40		$\mu\text{V}/\text{mA}$	At ambient
Output Current Load Capability ²		± 5		mA	$V_{DD} \geq 3\text{ V}$
Line Regulation ²		100		$\mu\text{V}/\text{V}$	At ambient
Thermal Hysteresis ²		125		ppm	First cycle
		25		ppm	Additional cycles
LOGIC INPUTS²					
Input Current			± 2	μA	Per pin
Input Low Voltage (V_{INL})			$0.3 \times V_{LOGIC}$	V	
Input High Voltage (V_{INH})	$0.7 \times V_{LOGIC}$			V	
Pin Capacitance		2		pF	

Parameter	Min	Typ	Max	Unit	Test Conditions/Comments
LOGIC OUTPUTS (SDO)²					
Output Low Voltage (V_{OL})			0.4	V	$I_{SINK} = 200 \mu A$ $I_{SOURCE} = 200 \mu A$
Output High Voltage (V_{OH})	$V_{LOGIC} - 0.4$			V	
Floating State Output Capacitance		4		pF	
POWER REQUIREMENTS					
V_{LOGIC}	1.8		5.5	V	Gain = 1
I_{LOGIC}			3	μA	
V_{DD}	2.7		5.5	V	Gain = 2
	$V_{REF} + 1.5$		5.5	V	
I_{DD}					$V_{IH} = V_{DD}, V_{IL} = GND, V_{DD} = 2.7 V \text{ to } 5.5 V$
Normal Mode ⁹		0.59	0.7	mA	Internal reference off
		1.1	1.3	mA	Internal reference on, at full scale
All Power-Down Modes ¹⁰		1	4	μA	$-40^{\circ}C \text{ to } +85^{\circ}C$
			6	μA	$-40^{\circ}C \text{ to } +105^{\circ}C$

¹ DC specifications tested with the outputs unloaded, unless otherwise noted. Upper dead band = 10 mV; it exists only when $V_{REF} = V_{DD}$ with gain = 1 or when $V_{REF}/2 = V_{DD}$ with gain = 2. Linearity calculated using a reduced code range of 4 to 1020.

² Guaranteed by design and characterization; not production tested.

³ Channel A can have an output current of up to 30 mA. Similarly, Channel B can have an output current of up to 30 mA, up to a junction temperature of 110°C.

⁴ $V_{DD} = 5 V$. The device includes current limiting that is intended to protect the device during temporary overload conditions. Junction temperature may be exceeded during current limit, but operation above the specified maximum operation junction temperature can impair device reliability.

⁵ When drawing a load current at either rail, the output voltage headroom with respect to that rail is limited by the 25 Ω typical channel resistance of the output devices. For example, when sinking 1 mA, the minimum output voltage = 25 $\Omega \times 1 \text{ mA} = 25 \text{ mV}$ (see Figure 28).

⁶ Initial accuracy presolder reflow is $\pm 750 \mu V$; output voltage includes the effects of preconditioning drift. See the Internal Reference Setup section.

⁷ Reference is trimmed and tested at two temperatures and is characterized from $-40^{\circ}C$ to $+105^{\circ}C$.

⁸ Reference temperature coefficient is calculated as per the box method. See the Terminology section for more information.

⁹ Interface is inactive, both DACs are active, and DAC outputs are unloaded.

¹⁰ Both DACs are powered down.

AC CHARACTERISTICS

$V_{DD} = 2.7 V \text{ to } 5.5 V$; $R_L = 2 \text{ k}\Omega \text{ to } GND$; $C_L = 200 \text{ pF to } GND$; $1.8 V \leq V_{LOGIC} \leq 5.5 V$; all specifications T_{MIN} to T_{MAX} , unless otherwise noted. Temperature range = $-40^{\circ}C \text{ to } +105^{\circ}C$, typical at $25^{\circ}C$. Guaranteed by design and characterization; not production tested.

Table 3.

Parameter ¹	Min	Typ	Max	Unit	Test Conditions/Comments
Output Voltage Settling Time		5	7	μs	$1/4$ to $3/4$ scale settling to ± 2 LSB
Slew Rate		0.8		V/ μs	
Digital-to-Analog Glitch Impulse		0.5		nV-sec	1 LSB change around major carry
Digital Feedthrough		0.13		nV-sec	
Digital Crosstalk		0.1		nV-sec	
Analog Crosstalk		0.2		nV-sec	
DAC-to-DAC Crosstalk		0.3		nV-sec	
Total Harmonic Distortion (THD) ²		-80		dB	At ambient, BW = 20 kHz, $V_{DD} = 5 V$, $f_{OUT} = 1 \text{ kHz}$
Output Noise Spectral Density (NSD)		300		nV/ \sqrt{Hz}	DAC code = midscale, 10 kHz; gain = 2
Output Noise		6		$\mu V \text{ p-p}$	0.1 Hz to 10 Hz
Signal-to-Noise Ratio (SNR)		90		dB	At ambient, BW = 20 kHz, $V_{DD} = 5 V$, $f_{OUT} = 1 \text{ kHz}$
Spurious Free Dynamic Range (SFDR)		83		dB	At ambient, BW = 20 kHz, $V_{DD} = 5 V$, $f_{OUT} = 1 \text{ kHz}$
Signal-to-Noise-and-Distortion Ratio (SINAD)		80		dB	At ambient, BW = 20 kHz, $V_{DD} = 5 V$, $f_{OUT} = 1 \text{ kHz}$

¹ See the Terminology section.

² Digitally generated sine wave at 1 kHz.

TIMING CHARACTERISTICS

All input signals are specified with $t_R = t_F = 1 \text{ ns/V}$ (10% to 90% of V_{DD}) and timed from a voltage level of $(V_{IL} + V_{IH})/2$. See Figure 2. $V_{DD} = 2.7 \text{ V to } 5.5 \text{ V}$, $1.8 \text{ V} \leq V_{LOGIC} \leq 5.5 \text{ V}$, $V_{REF} = 2.5 \text{ V}$. All specifications T_{MIN} to T_{MAX} , unless otherwise noted.

Table 4.

Parameter ¹	1.8 V ≤ V _{LOGIC} < 2.7 V		2.7 V ≤ V _{LOGIC} ≤ 5.5 V		Unit	Description
	Min	Max	Min	Max		
t ₁	33		20		ns	SCLK cycle time
t ₂	16		10		ns	SCLK high time
t ₃	16		10		ns	SCLK low time
t ₄	15		10		ns	SYNC to SCLK falling edge setup time
t ₅	5		5		ns	Data setup time
t ₆	5		5		ns	Data hold time
t ₇	15		10		ns	SCLK falling edge to SYNC rising edge
t ₈	20		20		ns	Minimum SYNC high time (update single channel or both channels)
t ₉	16		10		ns	SYNC falling edge to SCLK fall ignore
t ₁₀	25		15		ns	LDAC pulse width low
t ₁₁	30		20		ns	SCLK falling edge to LDAC rising edge
t ₁₂	20		20		ns	SCLK falling edge to LDAC falling edge
t ₁₃	30		30		ns	RESET minimum pulse width low
t ₁₄	30		30		ns	RESET pulse activation time
Power-Up Time	4.5		4.5		μs	Time that is required to exit power-down mode and enter the normal mode of operation; 24th clock edge to 90% of DAC midscale value with output unloaded

¹ Maximum SCLK frequency is 50 MHz at $V_{DD} = 2.7 \text{ V to } 5.5 \text{ V}$, $2.7 \text{ V} \leq V_{LOGIC} \leq V_{DD}$. Guaranteed by design and characterization; not production tested.

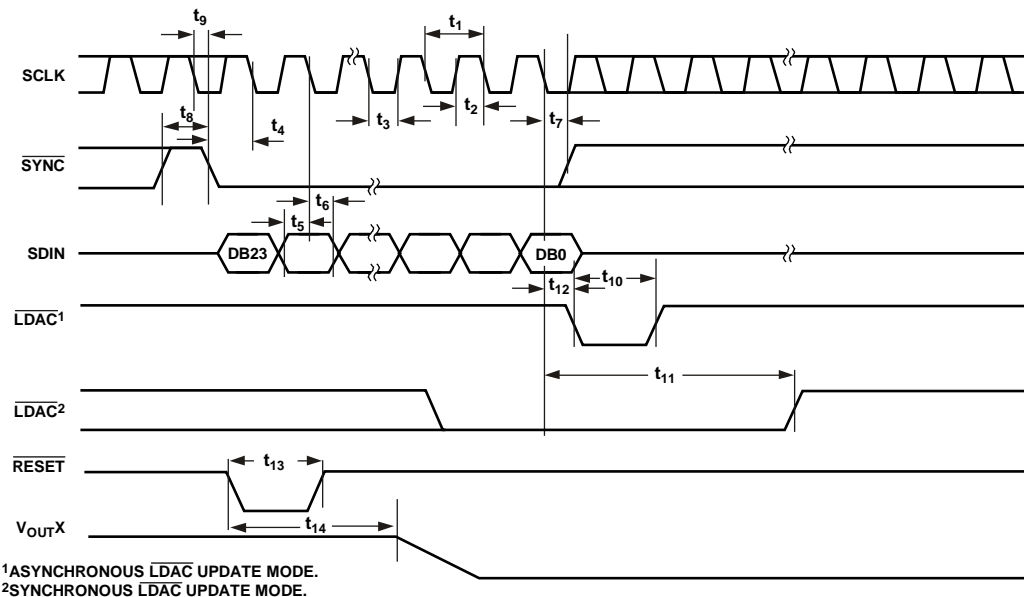

Figure 2. Serial Write Operation

11254-002

DAISY-CHAIN AND READBACK TIMING CHARACTERISTICS

All input signals are specified with $t_R = t_F = 1 \text{ ns/V}$ (10% to 90% of V_{DD}) and timed from a voltage level of $(V_{IL} + V_{IH})/2$. See Figure 4 and Figure 5. $V_{DD} = 2.7 \text{ V to } 5.5 \text{ V}$, $1.8 \text{ V} \leq V_{LOGIC} \leq 5.5 \text{ V}$, $V_{REF} = 2.5 \text{ V}$. All specifications T_{MIN} to T_{MAX} , unless otherwise noted. $V_{DD} = 2.7 \text{ V to } 5.5 \text{ V}$.

Table 5.

Parameter ¹	1.8 V ≤ V _{LOGIC} < 2.7 V		2.7 V ≤ V _{LOGIC} ≤ 5.5 V		Unit	Description
	Min	Max	Min	Max		
t ₁	66		40		ns	SCLK cycle time
t ₂	33		20		ns	SCLK high time
t ₃	33		20		ns	SCLK low time
t ₄	33		20		ns	$\overline{\text{SYNC}}$ to SCLK falling edge
t ₅	5		5		ns	Data setup time
t ₆	5		5		ns	Data hold time
t ₇	15		10		ns	SCLK falling edge to $\overline{\text{SYNC}}$ rising edge
t ₈	60		30		ns	Minimum $\overline{\text{SYNC}}$ high time
t ₉	60		30		ns	Minimum $\overline{\text{SYNC}}$ high time
t ₁₀		36		25	ns	SDO data valid from SCLK rising edge
t ₁₁	15		10		ns	SCLK falling edge to $\overline{\text{SYNC}}$ rising edge
t ₁₂	15		10		ns	$\overline{\text{SYNC}}$ rising edge to SCLK rising edge

¹ Maximum SCLK frequency is 25 MHz or 15 MHz at $V_{DD} = 2.7 \text{ V to } 5.5 \text{ V}$, $1.8 \text{ V} \leq V_{LOGIC} \leq V_{DD}$. Guaranteed by design and characterization; not production tested.

Circuit and Timing Diagrams

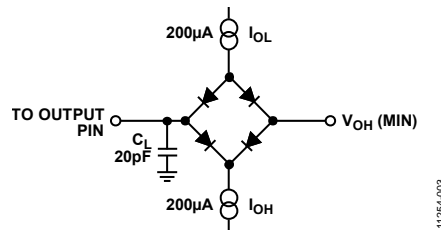

Figure 3. Load Circuit for Digital Output (SDO) Timing Specifications

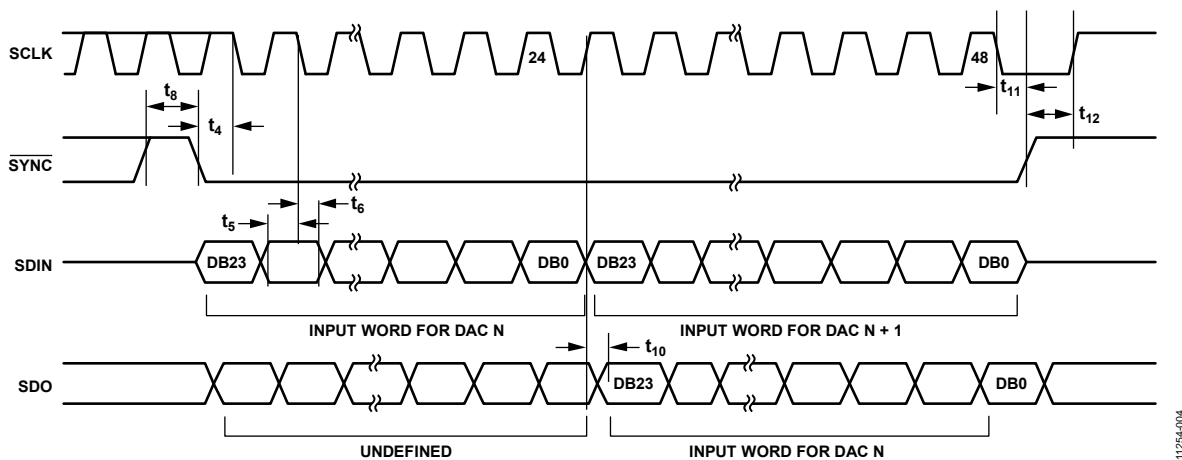

Figure 4. Daisy-Chain Timing Diagram

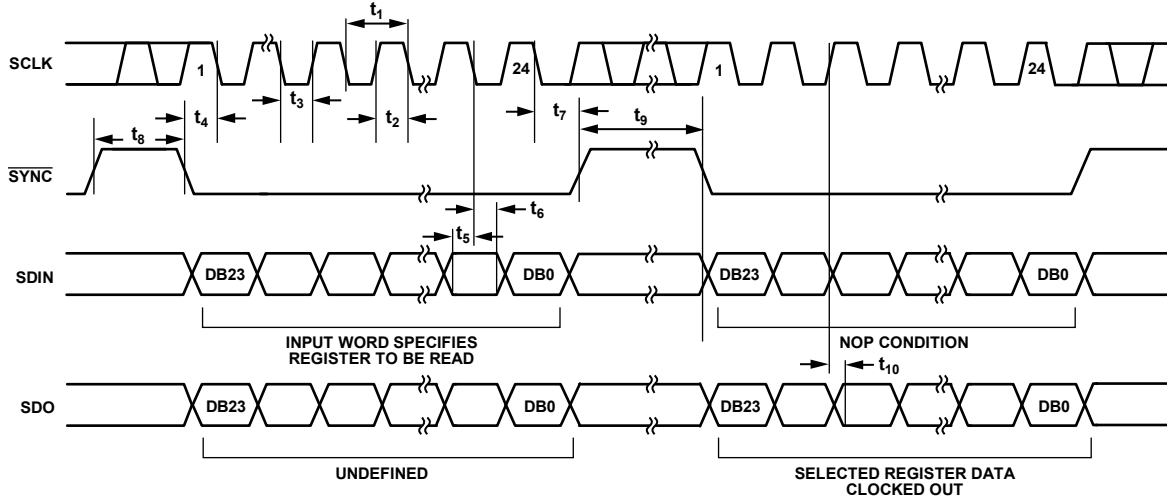

Figure 5. Readback Timing Diagram

11254-005

ABSOLUTE MAXIMUM RATINGS

$T_A = 25^\circ\text{C}$, unless otherwise noted.

Table 6.

Parameter	Rating
V_{DD} to GND	–0.3 V to +7 V
V_{LOGIC} to GND	–0.3 V to +7 V
V_{OUT} to GND	–0.3 V to $V_{DD} + 0.3$ V
V_{REF} to GND	–0.3 V to $V_{DD} + 0.3$ V
Digital Input Voltage to GND	–0.3 V to $V_{LOGIC} + 0.3$ V
Operating Temperature Range	–40°C to +105°C
Storage Temperature Range	–65°C to +150°C
Junction Temperature	125°C
16-Lead TSSOP, θ_{JA} Thermal Impedance, 0 Airflow (4-Layer Board)	112.6°C/W
16-Lead LFCSOP, θ_{JA} Thermal Impedance, 0 Airflow (4-Layer Board)	70°C/W
Reflow Soldering Peak Temperature, Pb Free (J-STD-020)	260°C
ESD ¹	4 kV
FICDM	1.5 kV

¹ Human body model (HBM) classification.

Stresses above those listed under Absolute Maximum Ratings may cause permanent damage to the device. This is a stress rating only; functional operation of the device at these or any other conditions above those indicated in the operational section of this specification is not implied. Exposure to absolute maximum rating conditions for extended periods may affect device reliability.

ESD CAUTION



ESD (electrostatic discharge) sensitive device. Charged devices and circuit boards can discharge without detection. Although this product features patented or proprietary protection circuitry, damage may occur on devices subjected to high energy ESD. Therefore, proper ESD precautions should be taken to avoid performance degradation or loss of functionality.

PIN CONFIGURATIONS AND FUNCTION DESCRIPTIONS

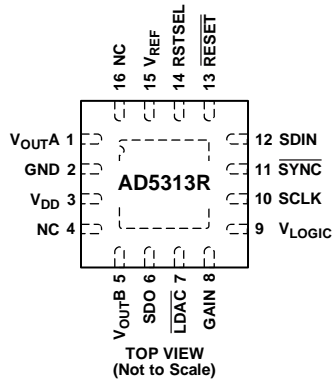

NOTES
 1. THE EXPOSED PAD MUST BE TIED TO GND.
 2. NC = NO CONNECT. DO NOT CONNECT TO THIS PIN.

Figure 6. 16-Lead LFCSP Pin Configuration

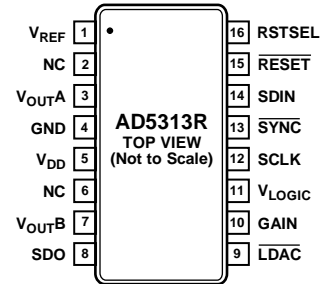

NOTES
 1. NC = NO CONNECT. DO NOT CONNECT TO THIS PIN.

Figure 7. 16-Lead TSSOP Pin Configuration

Table 7. Pin Function Descriptions

Pin No.		Mnemonic	Description
LFCSP	TSSOP		
1	3	V _{OUTA}	Analog Output Voltage from DAC A. The output amplifier has rail-to-rail operation.
2	4	GND	Ground Reference Point for All Circuitry on the AD5313R.
3	5	V _{DD}	Power Supply Input. The AD5313R can be operated from 2.7 V to 5.5 V. Decouple the supply with a 10 μF capacitor in parallel with a 0.1 μF capacitor to GND.
4	6	NC	No Connect. Do not connect to this pin.
5	7	V _{OUTB}	Analog Output Voltage from DAC B. The output amplifier has rail-to-rail operation.
6	8	SDO	Serial Data Output. SDO can be used to daisy-chain a number of AD5313R devices together, or it can be used for readback. The serial data is transferred on the rising edge of SCLK and is valid on the falling edge of the clock.
7	9	LDAC	LDAC can be operated in two modes: asynchronous and synchronous. Pulsing this pin low allows either or both DAC registers to be updated if the input registers have new data; both DAC outputs can be updated simultaneously. This pin can also be tied permanently low.
8	10	GAIN	Gain Select. When this pin is tied to GND, both DACs output a span from 0 V to V _{REF} . If this pin is tied to V _{LOGIC} , both DACs output a span of 0 V to 2 × V _{REF} .
9	11	V _{LOGIC}	Digital Power Supply. Voltage ranges from 1.8 V to 5.5 V.
10	12	SCLK	Serial Clock Input. Data is clocked into the input shift register on the falling edge of the serial clock input. Data can be transferred at rates of up to 50 MHz.
11	13	SYNC	Active Low Control Input. This is the frame synchronization signal for the input data. When SYNC goes low, data is transferred in on the falling edges of the next 24 clocks.
12	14	SDIN	Serial Data Input. This device has a 24-bit input shift register. Data is clocked into the register on the falling edge of the serial clock input.
13	15	RESET	Asynchronous Reset Input. The RESET input is falling edge sensitive. When RESET is low, all LDAC pulses are ignored. When RESET is activated, the input register and the DAC register are updated with zero scale or midscale, depending on the state of the RSTSEL pin. If the pin is not used, tie it permanently to V _{LOGIC} .
14	16	RSTSEL	Power-On Reset Select. Tying this pin to GND powers up both DACs to zero scale. Tying this pin to V _{LOGIC} powers up both DACs to midscale.
15	1	V _{REF}	Reference Voltage. The AD5313R has a common reference pin. When using the internal reference, this is the reference output pin. When using an external reference, this is the reference input pin. The default for this pin is as a reference output.
16	2	NC	No Connect. Do not connect to this pin.
17	N/A	EPAD	Exposed Pad. The exposed pad must be tied to GND.

TYPICAL PERFORMANCE CHARACTERISTICS

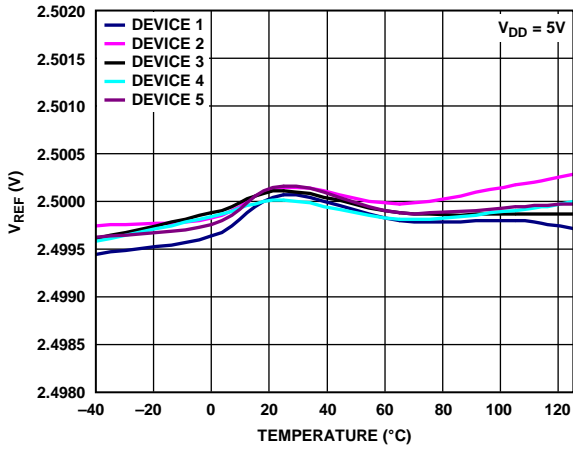

Figure 8. Internal Reference Voltage vs. Temperature

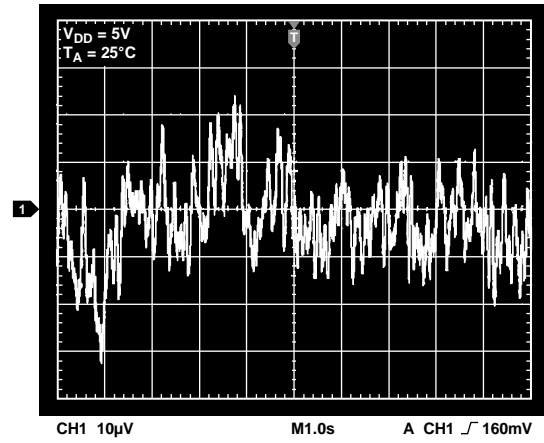

Figure 11. Internal Reference Noise, 0.1 Hz to 10 Hz

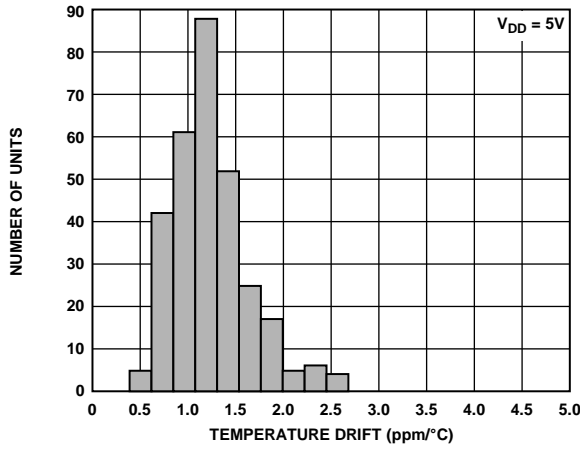

Figure 9. Reference Output Temperature Drift Histogram

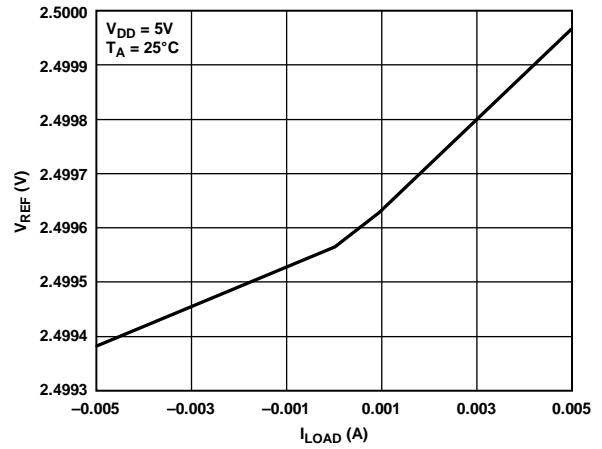

Figure 12. Internal Reference Voltage vs. Load Current

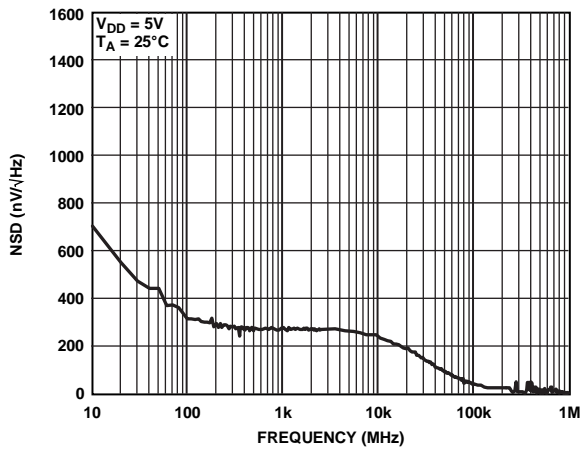

Figure 10. Internal Reference Noise Spectral Density vs. Frequency

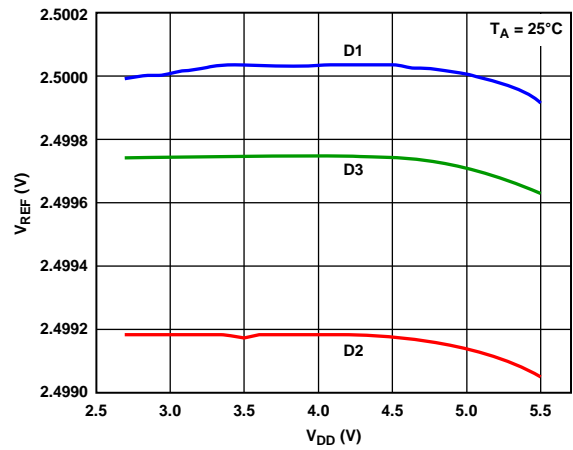

Figure 13. Internal Reference Voltage vs. Supply Voltage

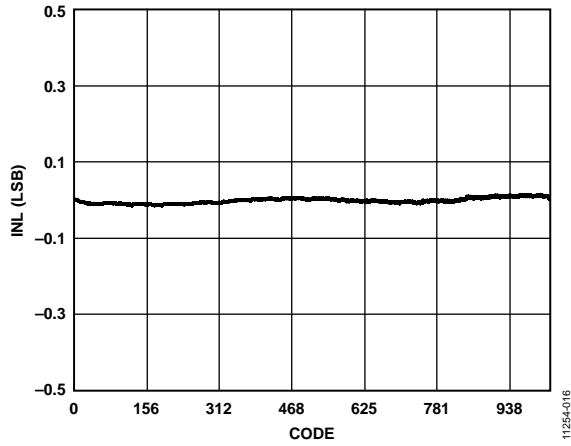

Figure 14. Integral Nonlinearity (INL) vs. Code

11254-016

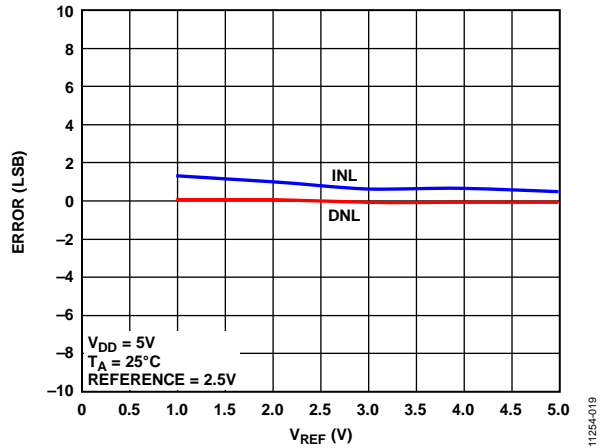

Figure 17. INL Error and DNL Error vs. V_{REF}

11254-019

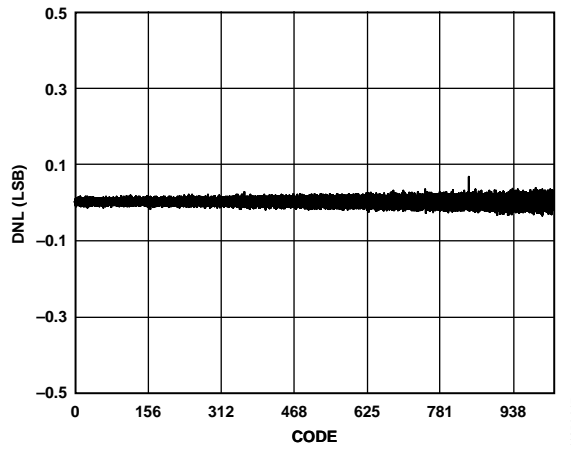

Figure 15. Differential Nonlinearity (DNL) vs. Code

11254-017

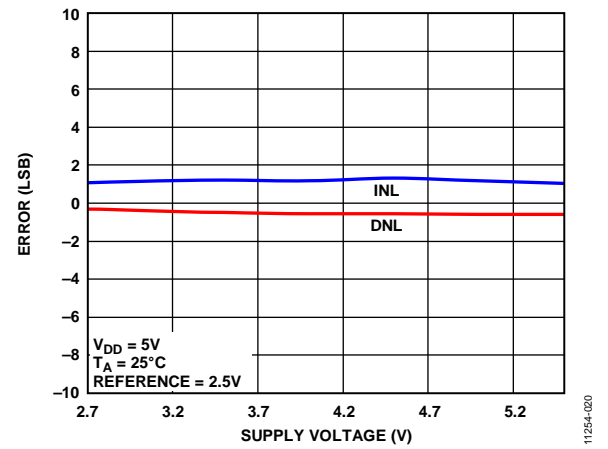

Figure 18. INL Error and DNL Error vs. Supply Voltage

11254-020

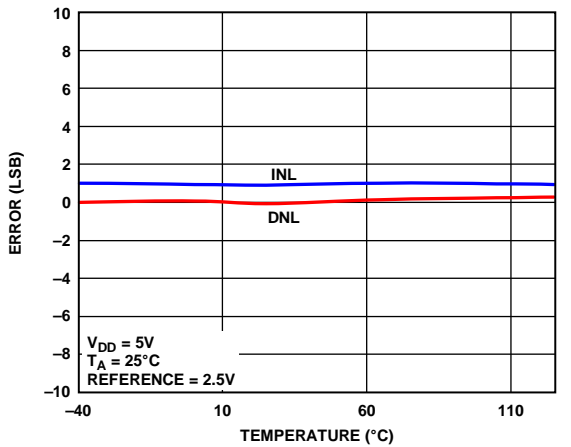

Figure 16. INL Error and DNL Error vs. Temperature

11254-018

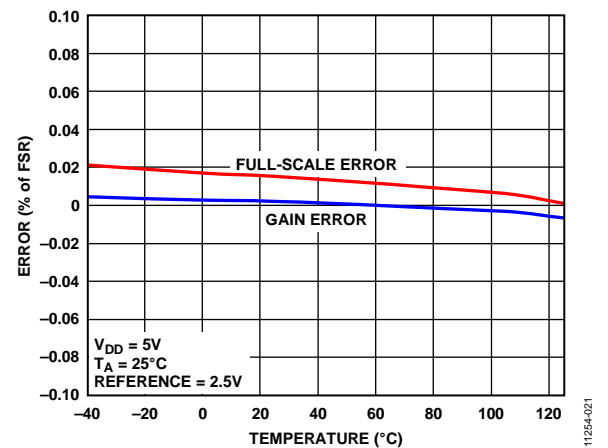

Figure 19. Gain Error and Full-Scale Error vs. Temperature

11254-021

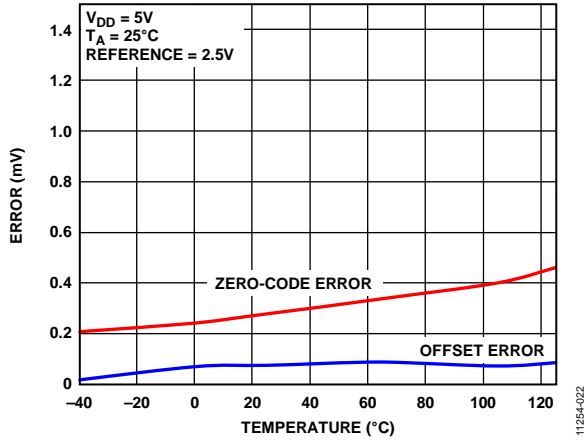

Figure 20. Zero-Code Error and Offset Error vs. Temperature

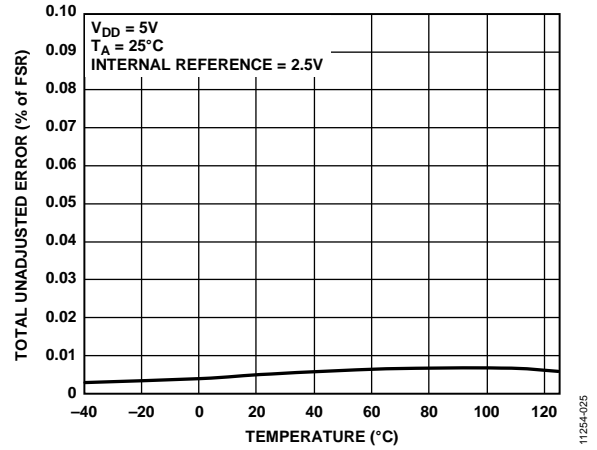

Figure 23. Total Unadjusted Error vs. Temperature

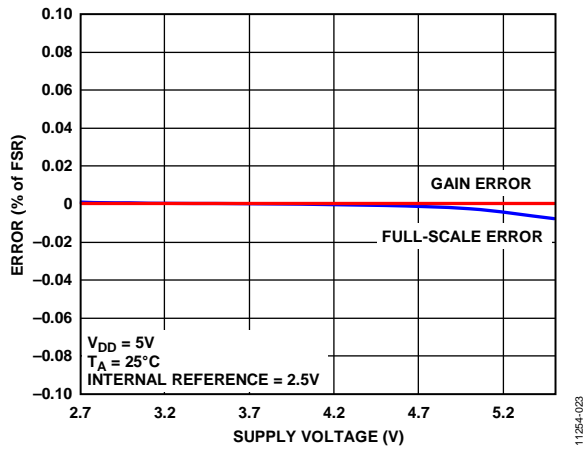

Figure 21. Gain Error and Full-Scale Error vs. Supply

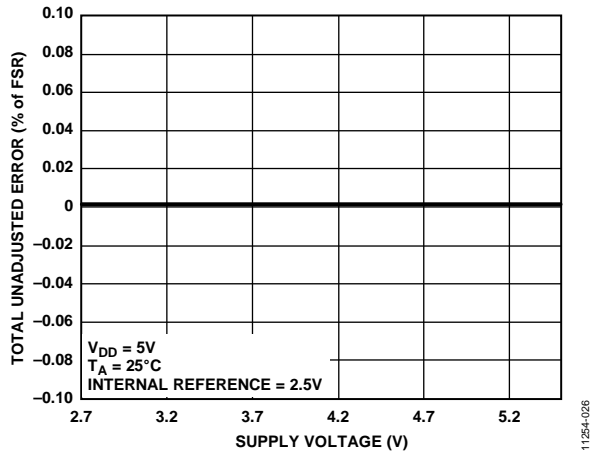

Figure 24. Total Unadjusted Error vs. Supply Voltage, Gain = 1

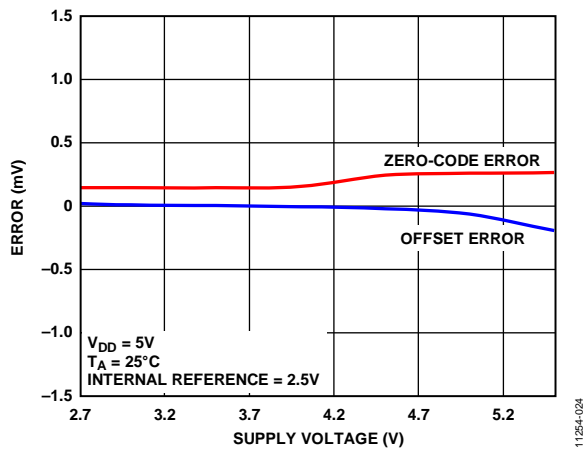

Figure 22. Zero-Code Error and Offset Error vs. Supply

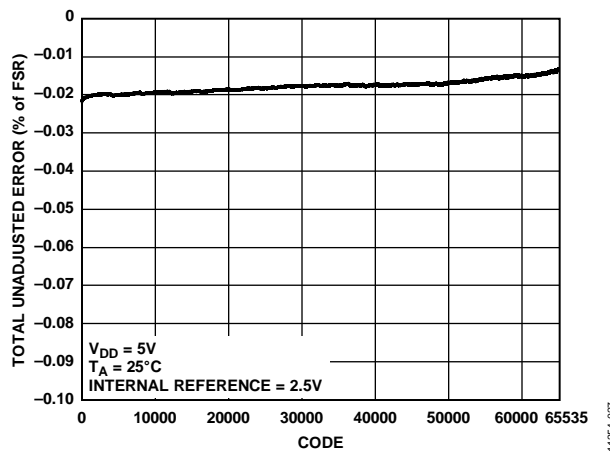

Figure 25. Total Unadjusted Error vs. Code

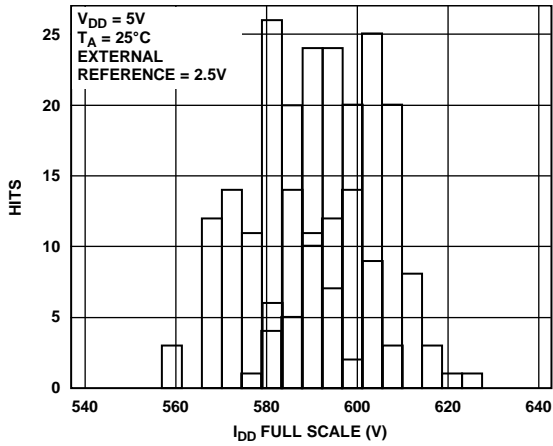

Figure 26. I_{DD} Histogram with External Reference, $V_{DD} = 5 V$

11254-028

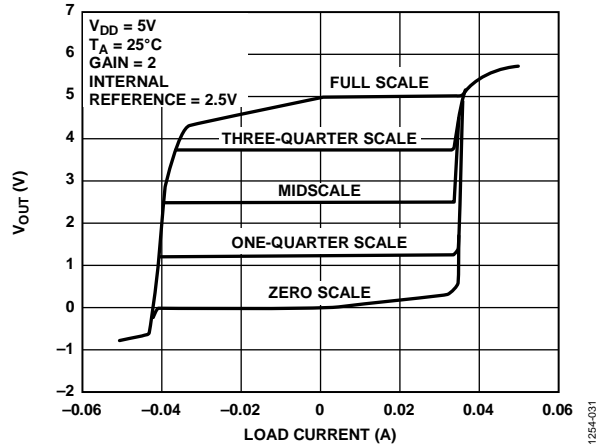

Figure 29. Source and Sink Capability at $V_{DD} = 5 V$

11254-031

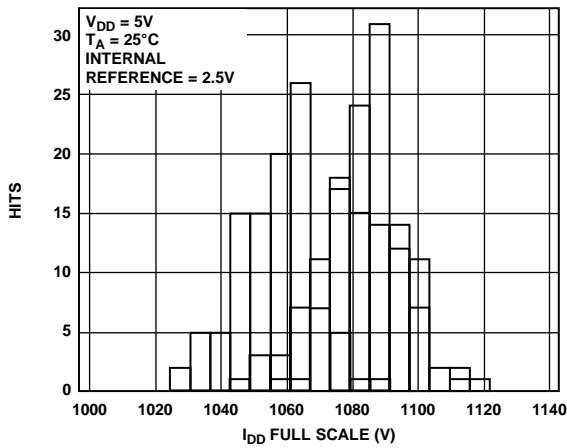

Figure 27. I_{DD} Histogram with Internal Reference, $V_{REF} = 2.5 V$, Gain = 2

11254-029

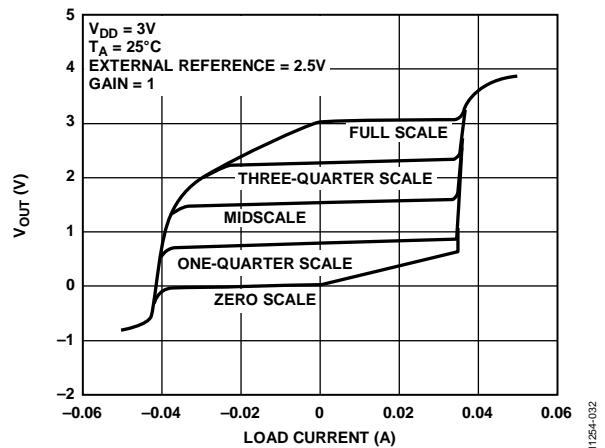

Figure 30. Source and Sink Capability at $V_{DD} = 3 V$

11254-032

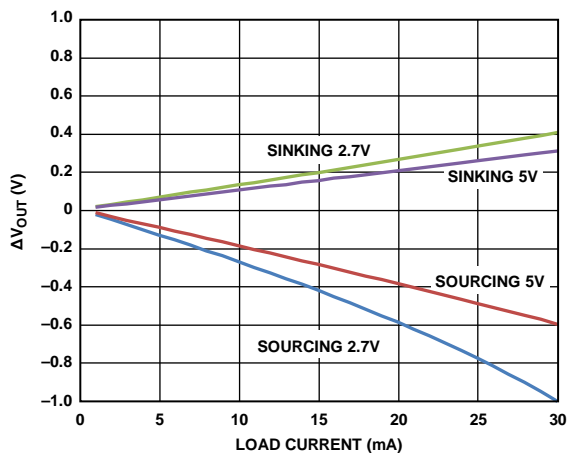

Figure 28. Headroom/Footroom vs. Load Current

11254-030

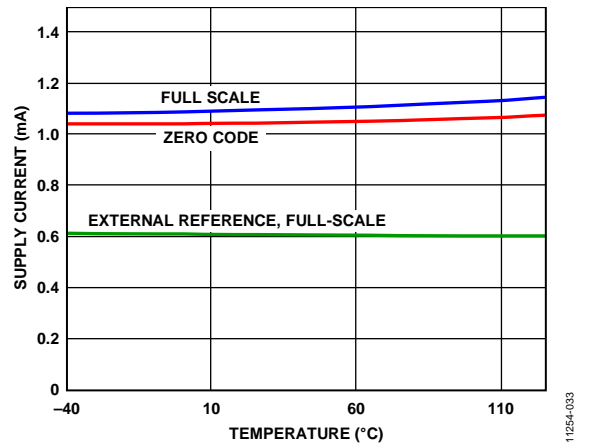

Figure 31. Supply Current vs. Temperature

11254-033

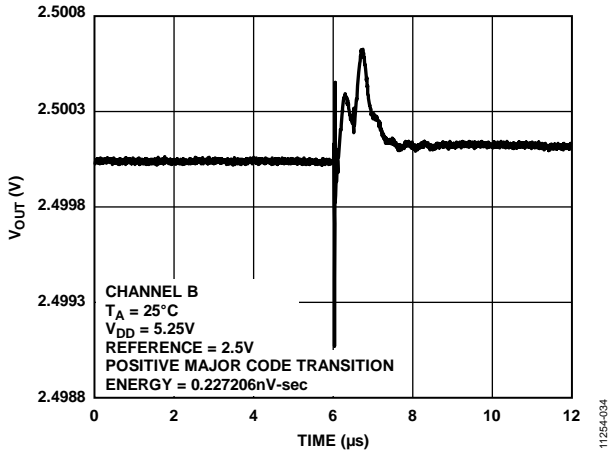

Figure 32. Digital-to-Analog Glitch Impulse

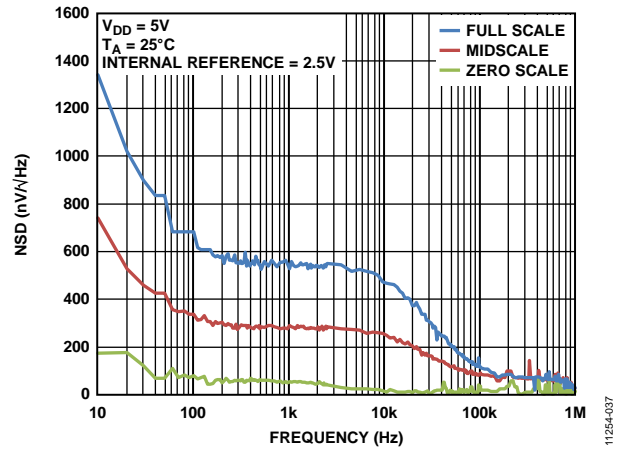

Figure 35. Noise Spectral Density

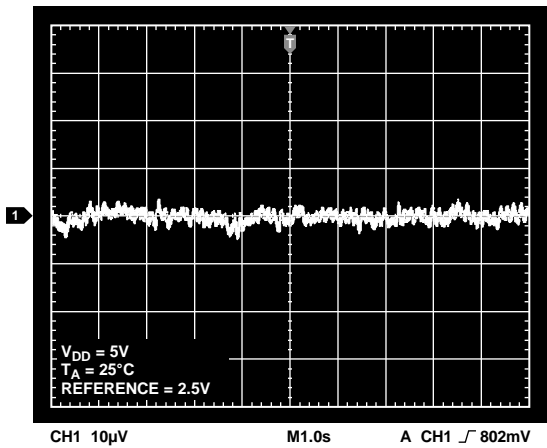

Figure 33. 0.1 Hz to 10 Hz Output Noise Plot, External Reference

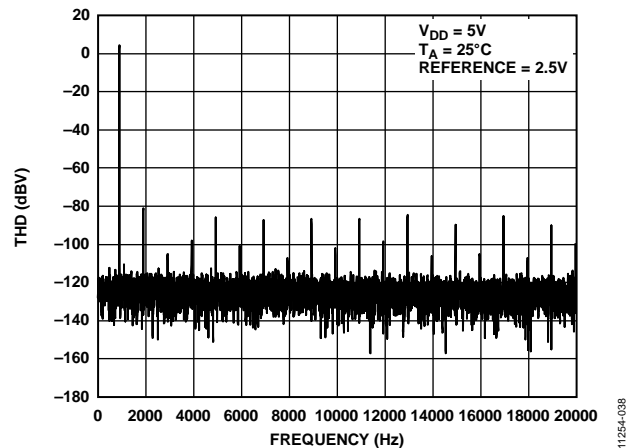

Figure 36. Total Harmonic Distortion at 1 kHz

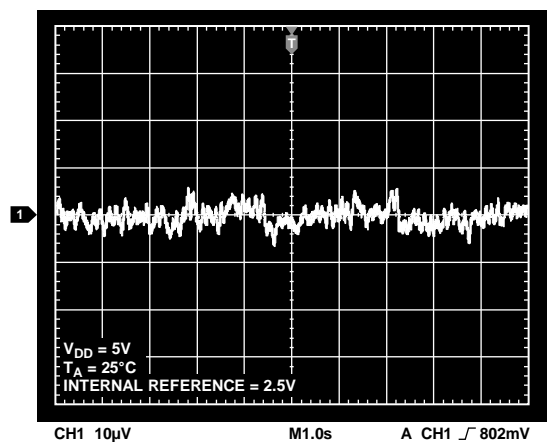

Figure 34. 0.1 Hz to 10 Hz Output Noise Plot, 2.5 V Internal Reference

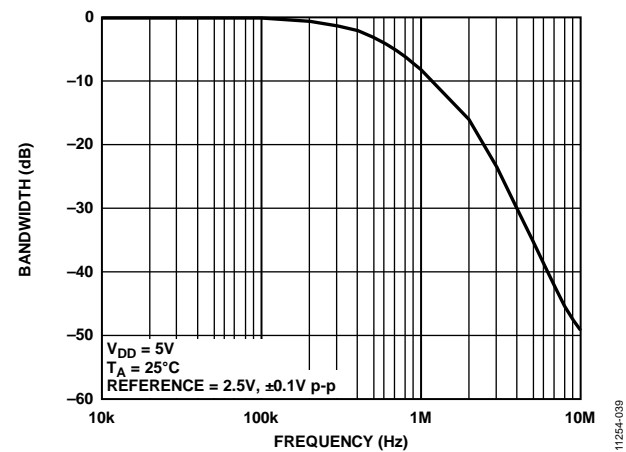

Figure 37. Multiplying Bandwidth, External Reference = 2.5 V, ±0.1 V p-p, 10 kHz to 10 MHz

TERMINOLOGY

Relative Accuracy or Integral Nonlinearity (INL)

For the DAC, relative accuracy or integral nonlinearity is a measurement of the maximum deviation, in LSBs, from a straight line passing through the endpoints of the DAC transfer function. A typical INL vs. code plot is shown in Figure 14.

Differential Nonlinearity (DNL)

Differential nonlinearity is the difference between the measured change and the ideal 1 LSB change between any two adjacent codes. A specified differential nonlinearity of ± 1 LSB maximum ensures monotonicity. This DAC is guaranteed monotonic by design. A typical DNL vs. code plot is shown in Figure 15

Zero-Code Error

Zero-code error is a measurement of the output error when zero code (0x0000) is loaded to the DAC register. Ideally, the output should be 0 V. The zero-code error is always positive in the AD5313R because the output of the DAC cannot go below 0 V due to a combination of the offset errors in the DAC and the output amplifier. Zero-code error is expressed in mV. A plot of zero-code error vs. temperature is shown in Figure 20.

Full-Scale Error

Full-scale error is a measurement of the output error when full-scale code (0xFFFF) is loaded to the DAC register. Ideally, the output should be $V_{DD} - 1$ LSB. Full-scale error is expressed in percent of full-scale range (% of FSR). A plot of full-scale error vs. temperature is shown in Figure 19.

Gain Error

Gain error is a measure of the span error of the DAC. It is the deviation in slope of the DAC transfer characteristic from the ideal and is expressed as % of FSR.

Offset Error Drift

Offset error drift is a measurement of the change in offset error with a change in temperature. It is expressed in $\mu\text{V}/^\circ\text{C}$.

Gain Temperature Coefficient

Gain temperature coefficient is a measurement of the change in gain error with changes in temperature. It is expressed in ppm of FSR/ $^\circ\text{C}$.

Offset Error

Offset error is a measure of the difference between V_{OUT} (actual) and V_{OUT} (ideal) expressed in mV in the linear region of the transfer function. Offset error is measured on the AD5313R with Code 8 loaded in the DAC register. It can be negative or positive.

DC Power Supply Rejection Ratio (PSRR)

PSRR indicates how the output of the DAC is affected by changes in the supply voltage. It is the ratio of the change in V_{OUT} to a change in V_{DD} for the full-scale output of the DAC. It is measured in mV/V. V_{REF} is held at 2 V, and V_{DD} is varied by $\pm 10\%$.

Output Voltage Settling Time

Output voltage settling time is the amount of time it takes for the output of a DAC to settle to a specified level for a $\frac{1}{4}$ to $\frac{3}{4}$ full-scale input change and is measured from the rising edge of SYNC.

Digital-to-Analog Glitch Impulse

Digital-to-analog glitch impulse is the impulse injected into the analog output when the input code in the DAC register changes state. It is normally specified as the area of the glitch in nV-sec and is measured when the digital input code is changed by 1 LSB at the major carry transition, that is, 0x7FFF to 0x8000 (see Figure 32).

Digital Feedthrough

Digital feedthrough is a measure of the impulse injected into the analog output of the DAC from the digital inputs of the DAC; it is measured when the DAC output is not updated. It is specified in nV-sec and measured with a full-scale code change on the data bus, that is, from all 0s to all 1s and vice versa.

Reference Feedthrough

Reference feedthrough is the ratio of the amplitude of the signal at the DAC output to the reference input when the DAC output is not being updated. It is expressed in dB.

Noise Spectral Density (NSD)

NSD is a measurement of the internally generated random noise. Random noise is characterized as a spectral density. It is measured, in $\text{nV}/\sqrt{\text{Hz}}$, by loading the DAC to midscale and measuring noise at the output. A plot of noise spectral density is shown in Figure 35.

DC Crosstalk

DC crosstalk is the dc change in the output level of one DAC in response to a change in the output of another DAC. It is measured with a full-scale output change (or soft power-down and power-up) on one DAC while monitoring another DAC kept at midscale. It is expressed in μV .

DC crosstalk due to load current change is a measure of the impact that a change in load current on one DAC has to another DAC kept at midscale. It is expressed in $\mu\text{V}/\text{mA}$.

Digital Crosstalk

Digital crosstalk is the glitch impulse transferred to the output of one DAC at midscale in response to a full-scale code change (all 0s to all 1s and vice versa) in the input register of another DAC. It is measured in standalone mode and expressed in nV-sec.

Analog Crosstalk

Analog crosstalk is the glitch impulse transferred to the output of one DAC due to a change in the output of another DAC. It is measured by loading one of the input registers with a full-scale code change (all 0s to all 1s and vice versa). Then execute a software LDAC and monitor the output of the DAC whose digital code was not changed. The area of the glitch is expressed in nV-sec.

DAC-to-DAC Crosstalk

DAC-to-DAC crosstalk is the glitch impulse transferred to the output of one DAC due to a digital code change and subsequent analog output change of another DAC. It is measured by loading the attack channel with a full-scale code change (all 0s to all 1s and vice versa), using the write to and update commands while monitoring the output of the victim channel that is at midscale. The energy of the glitch is expressed in nV-sec.

Multiplying Bandwidth

The amplifiers within the DAC have a finite bandwidth. The multiplying bandwidth is a measure of this. A sine wave on the reference (with full-scale code loaded to the DAC) appears on the output. The multiplying bandwidth is the frequency at which the output amplitude falls to 3 dB below the input.

Total Harmonic Distortion (THD)

THD is the difference between an ideal sine wave and its attenuated version using the DAC. The sine wave is used as the reference for the DAC, and the THD is a measurement of the harmonics present on the DAC output. It is measured in dB.

Voltage Reference Temperature Coefficient

Voltage reference TC is a measure of the change in the reference output voltage with a change in temperature. The reference TC is calculated using the box method, which defines the TC as the maximum change in the reference output over a given temperature range expressed in ppm/°C, as follows:

$$TC = \left[\frac{V_{REFmax} - V_{REFmin}}{V_{REFnom} \times TempRange} \right] \times 10^6$$

where:

V_{REFmax} is the maximum reference output measured over the total temperature range.

V_{REFmin} is the minimum reference output measured over the total temperature range.

V_{REFnom} is the nominal reference output voltage, 2.5 V.

$TempRange$ is the specified temperature range of -40°C to +105°C.

THEORY OF OPERATION

DIGITAL-TO-ANALOG CONVERTER (DAC)

The AD5313R is a dual 10-bit, serial input, voltage output DAC with an internal reference. The part operates from supply voltages of 2.7 V to 5.5 V. Data is written to the AD5313R in a 24-bit word format via a 3-wire serial interface. The AD5313R incorporates a power-on reset circuit to ensure that the DAC output powers up to a known output state. The device also has a software power-down mode that reduces the typical current consumption to 4 μ A.

TRANSFER FUNCTION

The internal reference is on by default. To use an external reference, only a nonreference option is available. Because the input coding to the DAC is straight binary, the ideal output voltage when using an external reference is given by

$$V_{OUT} = V_{REF} \times Gain \left[\frac{D}{2^N} \right]$$

where:

Gain is the output amplifier gain and is set to 1 by default. It can be set to $\times 1$ or $\times 2$ using the gain select pin. When the GAIN pin is tied to GND, both DAC outputs have a span from 0 V to V_{REF} . If the GAIN pin is tied to V_{LOGIC} , both DACs output a span of 0 V to $2 \times V_{REF}$.

D is the decimal equivalent of the binary code that is loaded to the DAC register as follows: 0 to 1,024 for the 10-bit device.

N is the DAC resolution.

DAC ARCHITECTURE

The DAC architecture consists of a string DAC followed by an output amplifier. Figure 38 shows a block diagram of the DAC architecture.

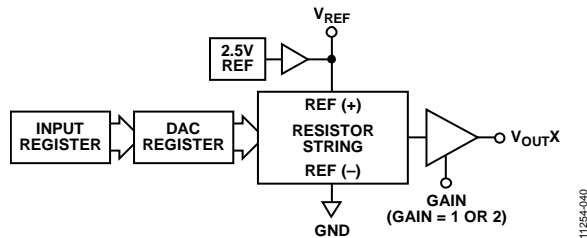

Figure 38. Single DAC Channel Architecture Block Diagram

The resistor string structure is shown in Figure 39. It is a string of resistors, each of Value *R*. The code loaded to the DAC register determines the node on the string where the voltage is to be tapped off and fed into the output amplifier. The voltage is tapped off

by closing one of the switches connecting the string to the amplifier. Because it is a string of resistors, it is guaranteed monotonic.

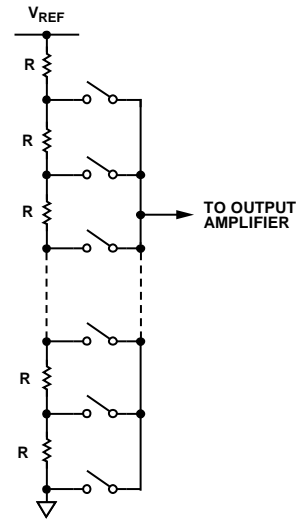

Figure 39. Resistor String Structure

Internal Reference

The AD5313R on-chip reference is on at power-up but can be disabled via a write to a control register. See the Internal Reference Setup section for details.

The AD5313R has a 2.5 V, 2 ppm/ $^{\circ}$ C reference, giving a full-scale output of 2.5 V or 5 V, depending on the state of the GAIN pin. The internal reference associated with the device is available at the V_{REF} pin. This buffered reference is capable of driving external loads of up to 10 mA.

Output Amplifiers

The output buffer amplifier can generate rail-to-rail voltages on its output, which gives an output range of 0 V to V_{DD} . The actual range depends on the value of V_{REF} , the GAIN pin, the offset error, and the gain error. The GAIN pin selects the gain of the output, as follows:

- If the GAIN pin is tied to GND, both DAC outputs have a gain of 1, and the output range is 0 V to V_{REF} .
- If the GAIN pin is tied to V_{LOGIC} , both DAC outputs have a gain of 2, and the output range is 0 V to $2 \times V_{REF}$.

These amplifiers are capable of driving a load of 1 k Ω in parallel with 2 nF to GND. The slew rate is 0.8 V/ μ s with a $\frac{1}{4}$ to $\frac{3}{4}$ scale settling time of 5 μ s.

SERIAL INTERFACE

The AD5313R has a 3-wire serial interface ($\overline{\text{SYNC}}$, SCLK, and SDIN) that is compatible with SPI, QSPI™, and MICROWIRE® interface standards as well as most DSPs. See Figure 2 for a timing diagram of a typical write sequence. The AD5313R contains an SDO pin that allows the user to daisy-chain multiple devices together (see the Daisy-Chain Operation section) or read back data.

Input Shift Register

The input shift register of the AD5313R is 24 bits wide, and data is loaded MSB first (DB23). The first four bits are the command bits (C3 to C0, as listed in Table 9), followed by the 4-bit DAC address bits listed in Table 8 (DAC B, two don't care bits set to 0, and DAC A). Finally, the data-word completes the input shift register.

The data-word comprises 10-bit input code, followed by six don't care bits (see Figure 40). These data bits are transferred to the input shift register on the 24 falling edges of SCLK and are updated on the rising edge of $\overline{\text{SYNC}}$.

Commands can be executed on individual DAC channels or on both DAC channels, depending on the address bits selected.

Table 8. Address Commands

DAC B	Address (n)		DAC A	Selected DAC Channel
	0	0		
0	0	0	1	DAC A
1	0	0	0	DAC B
1	0	0	1	DAC A and DAC B

Table 9. Command Definitions

Command				Description
C3	C2	C1	C0	
0	0	0	0	No operation
0	0	0	1	Write to Input Register n (dependent on $\overline{\text{LDAC}}$)
0	0	1	0	Update DAC Register n with contents of Input Register n
0	0	1	1	Write to and update DAC Channel n
0	1	0	0	Power down/power up DAC
0	1	0	1	Hardware $\overline{\text{LDAC}}$ mask register
0	1	1	0	Software reset (power-on reset)
0	1	1	1	Internal reference setup register
1	0	0	0	Set up DCEN register (daisy-chain enable)
1	0	0	1	Set up readback register (readback enable)
1	0	1	0	Reserved
...	Reserved
1	1	1	1	Reserved

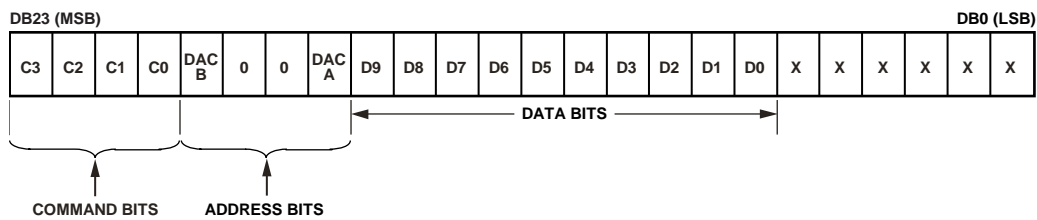

Figure 40. Input Shift Register Content

11254-042

STANDALONE OPERATION

The write sequence begins by bringing the SYNC line low. Data from the SDIN line is clocked into the 24-bit input shift register on the falling edge of SCLK. After the last of 24 data bits is clocked in, SYNC is brought high. The programmed function is then executed; that is, an LDAC-dependent change in DAC register contents and/or a change in the mode of operation occurs. If SYNC is taken high before the 24th clock, it is considered a valid frame, and invalid data may be loaded to the DAC. SYNC must be brought high for a minimum of 20 ns (single channel, see t_s in Figure 2) before the next write sequence so that a falling edge of SYNC can initiate the next write sequence. Idle SYNC at the rails between write sequences for an even lower power operation of the part. The SYNC line is kept low for 24 falling edges of SCLK, and the DAC is updated on the rising edge of SYNC.

When the data has been transferred into the input register of the addressed DAC, both DAC registers and outputs can be updated by taking LDAC low while the SYNC line is high.

WRITE AND UPDATE COMMANDS

Write to Input Register n (Dependent on LDAC)

Command 0001 allows the user to write to the dedicated input register of each DAC individually. When LDAC is low, the input register is transparent (if not controlled by the LDAC mask register).

Update DAC Register n with Contents of Input Register n

Command 0010 loads the DAC registers/outputs with the contents of the input registers selected and updates the DAC outputs directly.

Write to and Update DAC Channel n (Independent of LDAC)

Command 0011 allows the user to write to the DAC registers and update the DAC outputs directly.

DAISY-CHAIN OPERATION

For systems that contain several DACs, the SDO pin can be used to daisy-chain several devices together. SDO is enabled through a software executable daisy-chain enable (DCEN) command. Command 1000 is reserved for this DCEN function (see Table 9). The daisy-chain mode is enabled by setting Bit DB0 in the DCEN register. The default setting is standalone mode, where DB0 (LSB) = 0. Table 10 shows how the state of the bit corresponds to the mode of operation of the device.

Table 10. Daisy-Chain Enable (DCEN) Register

DB0 (LSB)	Description
0	Standalone mode (default)
1	DCEN mode

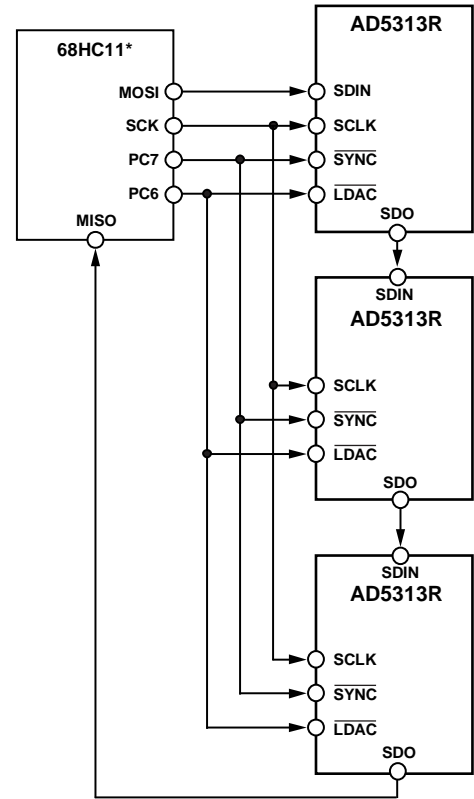

*ADDITIONAL PINS OMITTED FOR CLARITY.

Figure 41. Daisy-Chaining Multiple AD5313R Devices

The SCLK pin is continuously applied to the input shift register when SYNC is low. If more than 24 clock pulses are applied, the data ripples out of the input shift register and appears on the SDO line. This data is clocked out on the rising edge of SCLK and is valid on the falling edge. By connecting this line to the SDIN input on the next DAC in the chain, a daisy-chain interface is constructed. Each DAC in the system requires 24 clock pulses. Therefore, the total number of clock cycles must equal $24 \times N$, where N is the total number of devices that are updated. If SYNC is taken high at a clock that is not a multiple of 24, it is considered a valid frame, and invalid data may be loaded to the DAC. When the serial transfer to all devices is complete, SYNC is taken high. This latches the input data in each device in the daisy chain and prevents any further data from being clocked into the input shift register. The serial clock can be continuous or a gated clock. A continuous SCLK source can be used only if SYNC can be held low for the correct number of clock cycles. In gated clock mode, a burst clock containing the exact number of clock cycles must be used, and SYNC must be taken high after the final clock to latch the data.

READBACK OPERATION

Readback mode is invoked through a software executable readback command. If the SDO output is disabled via the daisy-chain mode disable bit in the control register, it is automatically enabled for the duration of the read operation, after which it is disabled again. Command 1001 is reserved for the readback function. This command, in association with selecting one of the address bits, DAC B or DAC A, determines the register to be read. Note that only one DAC register can be selected during readback. The remaining three address bits (which includes the two don't care bits) must be set to Logic 0. The remaining data bits in the write sequence are ignored. If more than one address bit is selected or no address bits are selected, DAC Channel A is read back by default. During the next SPI write, the data appearing on the SDO output contains the data from the previously addressed register.

For example, to read back the DAC register for Channel A, implement the following sequence:

1. Write 0x900000 to the AD5313R input register. This setting configures the part for read mode with the Channel A DAC register selected. Note that all data bits, DB15 to DB0, are don't care bits.
2. Follow this write operation with a second write, a NOP condition, 0x000000. During this write, the data from the register is clocked out on the SDO line. DB23 to DB20 contain undefined data, and the last 16 bits contain the DB19 to DB4 DAC register contents.

POWER-DOWN OPERATION

The AD5313R contains three separate power-down modes. Command 0100 controls the power-down function (see Table 9). These power-down modes are software-programmable by setting eight bits, Bit DB7 to Bit DB0, in the input shift register. There are two bits associated with each DAC channel. Table 11 explains how the state of the two bits corresponds to the mode of operation of the device.

Table 11. Modes of Operation

Operating Mode	PDx1	PDx0
Normal Operation Mode	0	0
Power-Down Modes		
1 k Ω to GND	0	1
100 k Ω to GND	1	0
Three-State	1	1

Table 12. 24-Bit Input Shift Register Contents of Power-Down/Power-Up Operation¹

DB23 (MSB)	DB22	DB21	DB20	DB19 to DB16	DB15 to DB8	DB7	DB6	DB5	DB4	DB3	DB2	DB1	DB0 (LSB)	
0	1	0	0	X	X	PDB1	PDB0	1	1	1	1	PDA1	PDA0	
Command bits (C3 to C0)				Address bits; don't care			Power-down, select DAC B		Set to 1		Set to 1		Power-down, select DAC A	

¹ X = don't care.

Either DAC or both DACs (DAC A and DAC B) can be powered down to the selected mode by setting the corresponding bits. See Table 12 for the contents of the input shift register during the power-down/power-up operation.

When both Bit PDx1 and Bit PDx0 (where x is the channel that is selected) in the input shift register are set to 0, the AD5313R works normally, with a normal power consumption of 4 mA at 5 V. However, for the three power-down modes of the AD5313R, the supply current falls to 4 μ A at 5 V. Not only does the supply current fall, but the output stage is also internally switched from the output of the amplifier to a resistor network of known values. This switchover has the advantage that the output impedance of the part is known while the part is in power-down mode. The three power-down options are as follows:

- The output is connected internally to GND through a 1 k Ω resistor.
- The output is connected internally to GND through a 100 k Ω resistor.
- The output is left open-circuited (three-state).

The output stage is illustrated in Figure 42.

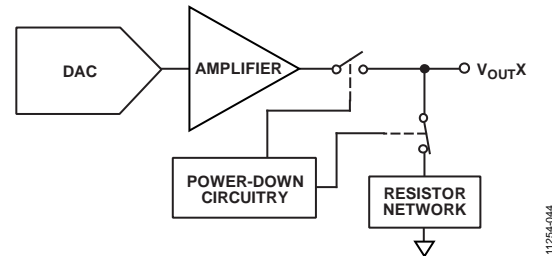

Figure 42. Output Stage During Power-Down

The bias generator, output amplifier, resistor string, and other associated linear circuitry are shut down when the power-down mode is activated. However, the contents of the DAC register are unaffected when in power-down, and the DAC register can be updated while the device is in power-down mode. The time that is required to exit power-down is typically 4.5 μ s for $V_{DD} = 5$ V.

To further reduce the current consumption, the on-chip reference can be powered off (see the Internal Reference Setup section).

LOAD DAC (HARDWARE $\overline{\text{LDAC}}$ PIN)

The AD5313R DACs have double buffered interfaces consisting of two banks of registers: input registers and DAC registers. The user can write to any combination of the input registers. Updates to the DAC register are controlled by the $\overline{\text{LDAC}}$ pin.

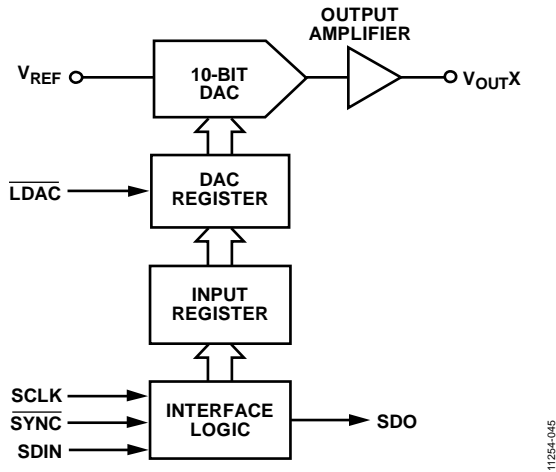

Figure 43. Simplified Diagram of Input Loading Circuitry for a Single DAC

Instantaneous DAC Updating ($\overline{\text{LDAC}}$ Held Low)

$\overline{\text{LDAC}}$ is held low while data is clocked into the input register using Command 0001. Both the addressed input register and the DAC register are updated on the rising edge of $\overline{\text{SYNC}}$, and then the output begins to change (see Table 14 and Table 15).

Table 14. 24-Bit Input Shift Register Contents for $\overline{\text{LDAC}}$ Operation¹

DB23 (MSB)	DB22	DB21	DB20	DB19	DB18	DB17	DB16	DB15 to DB4	DB3	DB2	DB1	DB0 (LSB)
0	0	0	1	X	X	X	X	X	DAC B	0	0	DAC A
Command bits (C3 to C0)				Address bits, don't care				Don't care	Setting the $\overline{\text{LDAC}}$ bit to 1 overrides the $\overline{\text{LDAC}}$ pin			

¹ X = don't care.

Table 15. Write Commands and $\overline{\text{LDAC}}$ Pin Truth Table¹

Command	Description	Hardware $\overline{\text{LDAC}}$ Pin State	Input Register Contents	DAC Register Contents
0001	Write to Input Register n (dependent on $\overline{\text{LDAC}}$)	V_{LOGIC}	Data update	No change (no update)
		GND ²	Data update	Data update
0010	Update DAC Register n with contents of Input Register n	V_{LOGIC}	No change	Updated with input register contents
		GND	No change	Updated with input register contents
0011	Write to and update DAC Channel n	V_{LOGIC}	Data update	Data update
		GND	Data update	Data update

¹ A high-to-low hardware $\overline{\text{LDAC}}$ pin transition always updates the contents of the DAC register with the contents of the input register on channels that are not masked (blocked) by the $\overline{\text{LDAC}}$ mask register.

² When the $\overline{\text{LDAC}}$ pin is permanently tied low, the $\overline{\text{LDAC}}$ mask bits are ignored.

Deferred DAC Updating ($\overline{\text{LDAC}}$ Pulsed Low)

$\overline{\text{LDAC}}$ is held high while data is clocked into the input register using Command 0001. Both DAC outputs are asynchronously updated by taking $\overline{\text{LDAC}}$ low after $\overline{\text{SYNC}}$ is taken high. The update then occurs on the falling edge of $\overline{\text{LDAC}}$.

$\overline{\text{LDAC}}$ MASK REGISTER

Command 0101 is reserved for a software $\overline{\text{LDAC}}$ mask function, which allows the address bits to be ignored. A write to the DAC using Command 0101 loads the 4-bit $\overline{\text{LDAC}}$ mask register (DB3 to DB0). The default setting for each channel is 0; that is, the $\overline{\text{LDAC}}$ pin works normally. Setting the selected bit to 1 forces the DAC channel to ignore transitions on the $\overline{\text{LDAC}}$ pin, regardless of the state of the hardware $\overline{\text{LDAC}}$ pin. This flexibility is useful in applications where the user wishes to select which channels respond to the $\overline{\text{LDAC}}$ pin.

The $\overline{\text{LDAC}}$ mask register gives the user extra flexibility and control over the hardware $\overline{\text{LDAC}}$ pin (see Table 13). Setting an $\overline{\text{LDAC}}$ bit (DB3, DB0) to 0 for a DAC channel means that the update of this channel is controlled by the hardware $\overline{\text{LDAC}}$ pin.

Table 13. $\overline{\text{LDAC}}$ Overwrite Definition

Load $\overline{\text{LDAC}}$ Register		$\overline{\text{LDAC}}$ Operation
$\overline{\text{LDAC}}$ Bits (DB3, DB0)	$\overline{\text{LDAC}}$ Pin	
0	1 or 0	Determined by the $\overline{\text{LDAC}}$ pin.
1	X ¹	DAC channels update and override the $\overline{\text{LDAC}}$ pin. DAC channels see the $\overline{\text{LDAC}}$ pin as set to 1.

¹ X = don't care.

HARDWARE RESET ($\overline{\text{RESET}}$)

$\overline{\text{RESET}}$ is an active low reset that allows the outputs to be cleared to either zero scale or midscale. The clear code value is user selectable via the power-on reset select pin (RSTSEL). $\overline{\text{RESET}}$ must be kept low for a minimum amount of time to complete the operation (see Figure 2). When the $\overline{\text{RESET}}$ signal is returned high, the output remains at the cleared value until a new value is programmed. The outputs cannot be updated with a new value while the $\overline{\text{RESET}}$ pin is low. There is also a software executable reset function that resets the DAC to the power-on reset code. Command 0110 is designated for this software reset function (see Table 9). Any events on $\overline{\text{LDAC}}$ or $\overline{\text{RESET}}$ during a power-on reset are ignored.

RESET SELECT PIN (RSTSEL)

The AD5313R contains a power-on reset circuit that controls the output voltage during power-up. When the RSTSEL pin is connected low (to GND), the output powers up to zero scale. Note that this is outside the linear region of the DAC. When the RSTSEL pin is connected high (to V_{LOGIC}), V_{OUTX} powers up to midscale. The output remains powered up at this level until a valid write sequence is sent to the DAC.

INTERNAL REFERENCE SETUP

Command 0111 is reserved for setting up the internal reference (see Table 9). By default, the on-chip reference is on at power-up. To reduce the supply current, this reference can be turned off by setting the software-programmable bit, DB0, as shown in Table 17. Table 16 shows how the state of the bit corresponds to the mode of operation.

Table 16. Internal Reference Setup Register

Internal Reference Setup Register (DB0)	Action
0	Reference on (default)
1	Reference off

Table 17. 24-Bit Input Shift Register Contents for Internal Reference Setup Command¹

DB23 (MSB)	DB22	DB21	DB20	DB19	DB18	DB17	DB16	DB15 to DB1	DB0 (LSB)
0	1	1	1	X	X	X	X	X	0 or 1
Command bits (C3 to C0)				Address bits (A3 to A0)				Don't care	Reference setup register

¹ X = don't care

SOLDER HEAT REFLOW

As with all IC reference voltage circuits, the reference value experiences a shift induced by the soldering process. Analog Devices, Inc., performs a reliability test, called precondition, that mimics the effect of soldering a device to a board. The output voltage specification that is listed in Table 2 includes the effect of this reliability test.

Figure 44 shows the effect of solder heat reflow (SHR) as measured through the reliability test (precondition).

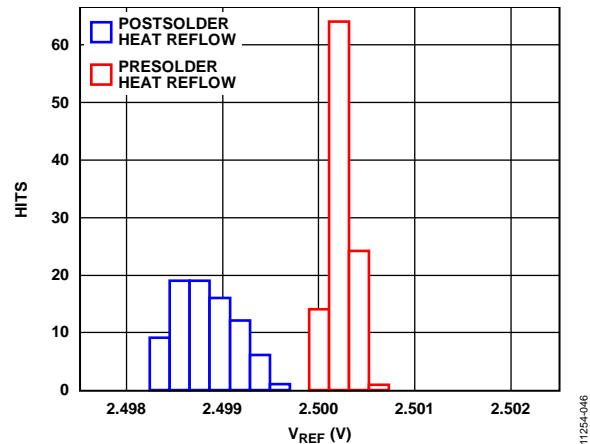

Figure 44. SHR Reference Voltage Shift

THERMAL HYSTERESIS

Thermal hysteresis is the voltage difference induced on the reference voltage by sweeping the temperature from ambient to cold, then to hot, and then back to ambient.

Thermal hysteresis data is shown in Figure 45. It is measured by sweeping the temperature from ambient to -40°C , next to $+105^{\circ}\text{C}$, and then returning to ambient. The V_{REF} delta is then measured between the two ambient measurements and shown in blue in Figure 45. The same temperature sweep and measurements are immediately repeated, and the results are shown in red in Figure 45.

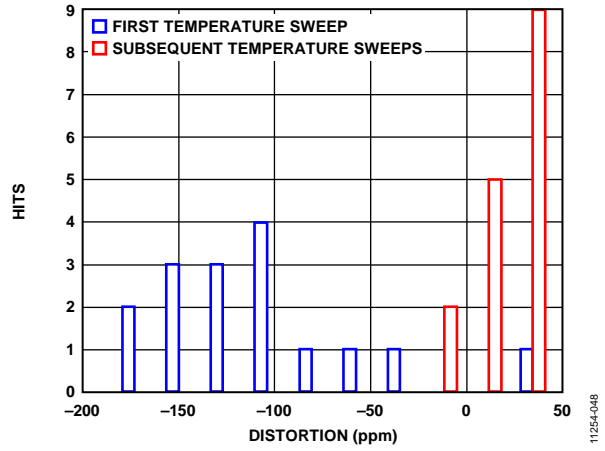

Figure 45. Thermal Hysteresis

11254-048

APPLICATIONS INFORMATION

MICROPROCESSOR INTERFACING

Microprocessor interfacing to the [AD5313R](#) is achieved via a serial bus using a standard protocol that is compatible with DSP processors and microcontrollers. The communications channel requires a 3-wire or 4-wire interface consisting of a clock signal, a data signal, and a synchronization signal. The device requires a 24-bit data-word with data valid on the rising edge of SYNC.

AD5313R TO ADSP-BF531 INTERFACE

The SPI interface of the [AD5313R](#) is designed to be easily connected to industry-standard DSPs and microcontrollers. Figure 46 shows the [AD5313R](#) connected to an Analog Devices Blackfin® DSP. The Blackfin has an integrated SPI port that can be connected directly to the SPI pins of the [AD5313R](#).

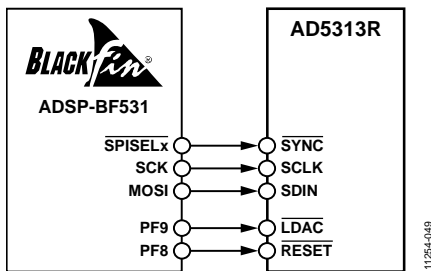

Figure 46. [AD5313R](#) to [ADSP-BF531](#) Interface

AD5313R TO SPORT INTERFACE

The Analog Devices [ADSP-BF527](#) has one SPORT serial port. Figure 47 shows how one SPORT interface can be used to control the [AD5313R](#).

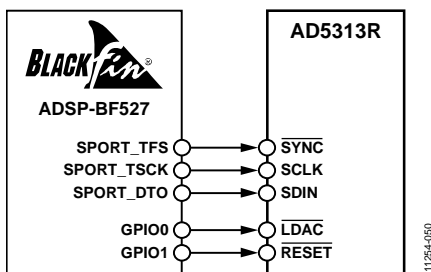

Figure 47. [AD5313R](#) to SPORT Interface

LAYOUT GUIDELINES

In any circuit where accuracy is important, careful consideration of the power supply and ground return layout helps to ensure the rated performance. Design the PCB on which the [AD5313R](#) is mounted such that the [AD5313R](#) lies on the analog plane.

Provide the [AD5313R](#) with ample supply bypassing of 10 μF in parallel with 0.1 μF on each supply, located as close to the package as possible, ideally right up against the device. The 10 μF capacitors are of the tantalum bead type. Use a 0.1 μF capacitor with low effective series resistance (ESR) and low effective series inductance (ESI), such as the common ceramic types, which provide a low impedance path to ground at high frequencies to handle transient currents due to internal logic switching.

In systems where there are many devices on one board, it is often useful to provide some heat sinking capability to allow the power to dissipate easily.

The [AD5313R](#) has an exposed paddle beneath the device. Connect this paddle to the GND supply for the part. For optimum performance, use special considerations to design the motherboard and to mount the package. For enhanced thermal, electrical, and board level performance, solder the exposed paddle on the bottom of the package to the corresponding thermal land paddle on the PCB. Design thermal vias into the PCB land paddle area to further improve heat dissipation.

The GND plane on the device can be increased (as shown in Figure 48) to provide a natural heat sinking effect.

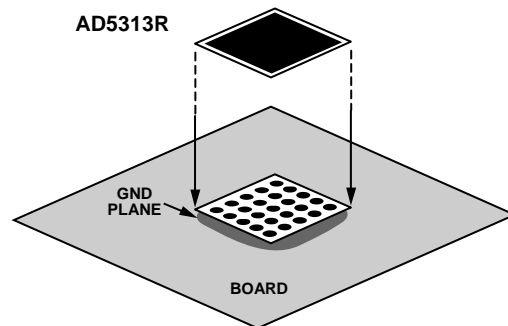
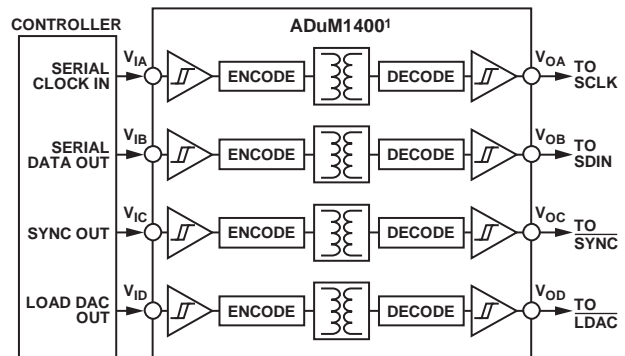

Figure 48. Paddle Connection to Board

GALVANICALLY ISOLATED INTERFACE

In many process control applications, it is necessary to provide an isolation barrier between the controller and the unit being controlled to protect and isolate the controlling circuitry from any hazardous common-mode voltages that may occur. The *iCoupler*® products from Analog Devices provide voltage isolation in excess of 2.5 kV. The serial loading structure of the [AD5313R](#) makes the part ideal for isolated interfaces because the number of interface lines is kept to a minimum. Figure 49 shows a 4-channel isolated interface to the [AD5313R](#) using an [ADuM1400](#). For more information, visit <http://www.analog.com/icouplers>.



¹ADDITIONAL PINS OMITTED FOR CLARITY.

Figure 49. Isolated Interface

OUTLINE DIMENSIONS

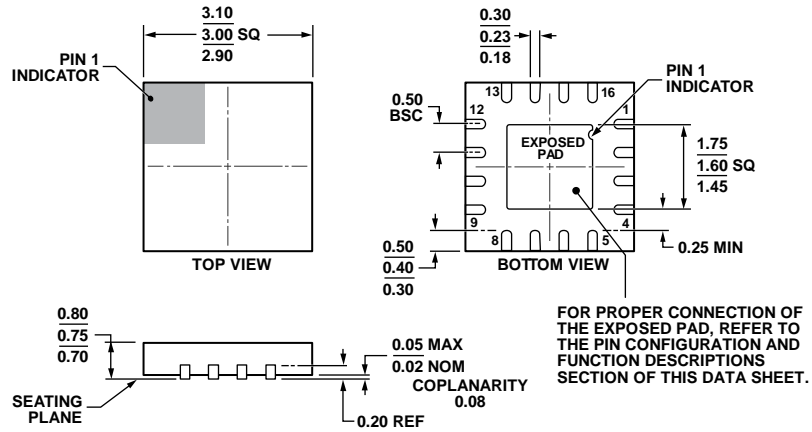

COMPLIANT TO JEDEC STANDARDS MO-220-WEED-6.

Figure 50. 16-Lead Lead Frame Chip Scale Package [LFCSP_WQ]
3 mm x 3 mm Body, Very Very Thin Quad
(CP-16-22)
Dimensions shown in millimeters

08-16-2010-E

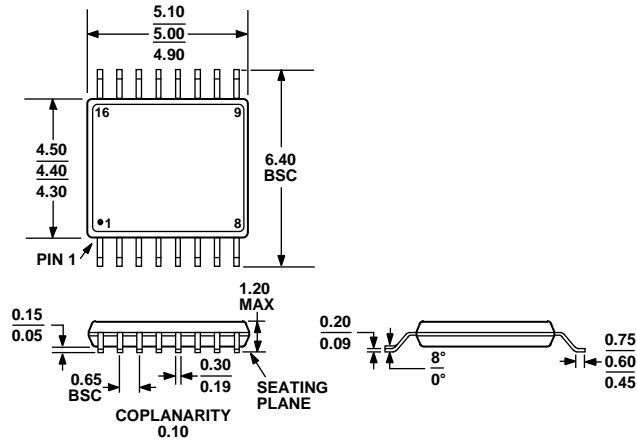

COMPLIANT TO JEDEC STANDARDS MO-153-AB

Figure 51. 16-Lead Thin Shrink Small Outline Package [TSSOP]
(RU-16)
Dimensions shown in millimeters

ORDERING GUIDE

Model ¹	Resolution	Temperature Range	Accuracy	Reference Tempco (ppm/°C)	Package Description	Package Option	Branding
AD5313RBCPZ-RL7	10 Bits	-40°C to +105°C	±2 LSB INL	±5 (max)	16-Lead LFCSP_WQ	CP-16-22	DKZ
AD5313RBRUZ	10 Bits	-40°C to +105°C	±2 LSB INL	±5 (max)	16-Lead TSSOP	RU-16	
AD5313RBRUZ-RL7	10 Bits	-40°C to +105°C	±2 LSB INL	±5 (max)	16-Lead TSSOP	RU-16	

¹ Z = RoHS Compliant Part.

NOTES

NOTES

NOTES