





Datasheet

Stock Number:	188-1156	188-1157	188-1158	188-1159	188-1160	188-1161
						
Colour:	GREEN	GREEN	RED	RED	AMBER	AMBER

22mm Illuminated Selector Switch Head – 2 Position

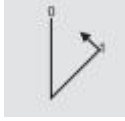

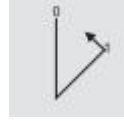
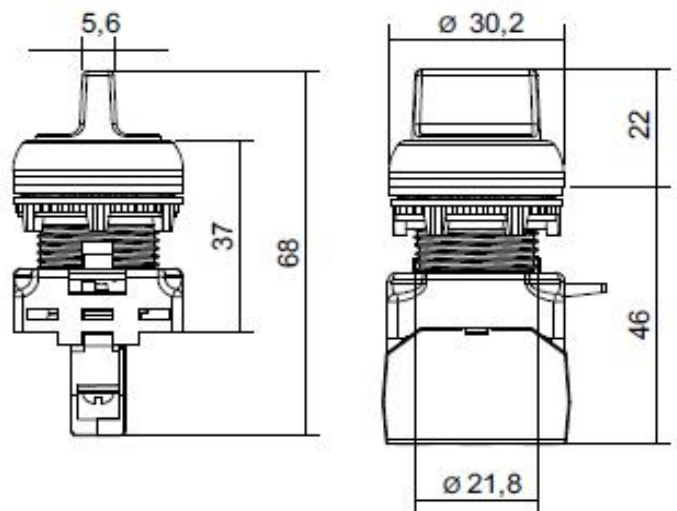
Illuminated 2 position selector switch heads for use with the RS pro modular plastic push button series. Robust design in Green, Red and Amber with modern silver coloured bezel. Simple installation via standard lock nut.

Specifications:

- 22mm Diameter
- Latching and Sprung return head options
- IP65 rated
- Contact block row clip included
- Stackable design for contact blocks (max 6)
- Mechanical life more than 1 million uses.

Stock Number:	188-1156	188-1157	188-1158	188-1159	188-1160	188-1161
Colour	Green	Green	Red	Red	Amber	Amber
Actuation	2 Position 0° – 30°	2 Position return 0° – 30°	2 Position 0° – 30°	2 Position return 0° – 30°	2 Position 0° – 30°	2 Position return 0° – 30°
Illuminated	Yes					
Cut out Diameter	22.5mm					
Actuation	Spring Return					
Style	Round					
IP Rating	IP65					
Shape	Round					
Mounting Type	Panel Mounted					
Body Material	Plastic					

Accessories:

RS Stock Number	Accessory Type
188-1168	Normally Open Contact Block – Screw Terminal
188-1169	Normally Closed Contact Block – Screw Terminal
188-1170	Normally Open Contact Block – Spring Terminal
188-1171	Normally Closed Contact Block – Spring Terminal
188-1172	LED Light Block Red 12Vac/dc
188-1173	LED Light Block Blue 12Vac/dc
188-1174	LED Light Block White 12Vac/dc
188-1176	LED Light Block Yellow 12Vac/dc
188-1177	LED Light Block Green 12Vac/dc
188-1178	LED Light Block Amber 12Vac/dc
188-1179	LED Light Block Red 24Vac/dc
188-1180	LED Light Block Blue 24Vac/dc
188-1182	LED Light Block White 24Vac/dc
188-1183	LED Light Block Yellow 24Vac/dc
188-1184	LED Light Block Green 24Vac/dc
188-1185	LED Light Block Amber 24Vac/dc
188-1186	LED Light Block Red 110Vac
188-1187	LED Light Block Blue 110Vac
188-1188	LED Light Block White 110Vac
188-1189	LED Light Block Yellow 110Vac



ENGLISH

188-1190	LED Light Block Green 110Vac
188-1191	LED Light Block Amber 110Vac
188-1192	LED Light Block Red 240Vac
188-1193	LED Light Block Blue 240Vac
188-1194	LED Light Block White 240Vac
188-1195	LED Light Block Yellow 240Vac
188-1196	LED Light Block Green 240Vac
188-1198	LED Light Block Amber 240Vac
175-3954	Legend Plate 0-I Pack of 5
175-3959	Legend Plate I-O-II Pack of 5
182-8655	Pushbutton Enclosure, 1 Hole, Plastic, Grey, 22mm Cut Out
182-8656	Pushbutton Enclosure, 2 Hole, Plastic, Grey, 22mm Cut Outs
182-8657	Pushbutton Enclosure, 3 Hole, Plastic, Grey, 22mm Cut Outs
182-8658	Pushbutton Enclosure, 4 Hole, Plastic, Grey, 22mm Cut Outs
136-8582	Pushbutton Enclosure, 1 Hole, Die Cast Aluminium, Yellow, 22mm Cut Out
136-8581	Pushbutton Enclosure, 1 Hole, Die Cast Aluminium, Yellow, 22mm Cut Out