

# ENCLOSED VARIABLE TRANSFORMERS INSTALLATION AND SAFETY INSTRUCTIONS

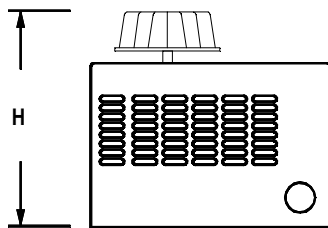
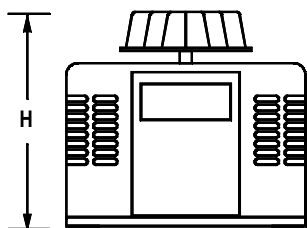
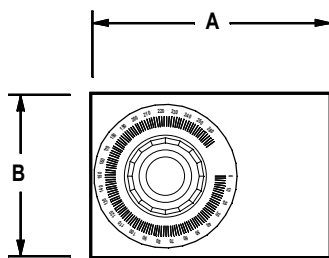
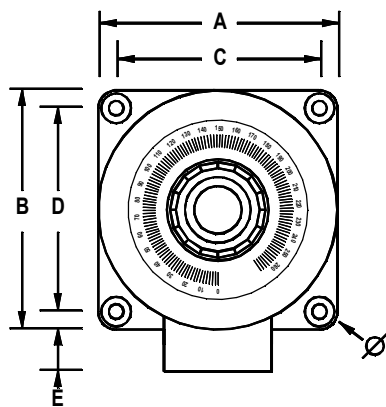

4 TO 28 AMP UNITS

0.7 TO 3 AMP UNITS

INPUT : 240V 1 Ph 50/60Hz AT 1-2 OR 1-4  
OUTPUT : 0-270V OR 0-240 AT 1-3

INPUT 240 V AT C-A OR C-B  
OUTPUT 0-240 OR 0-270 AT C-E

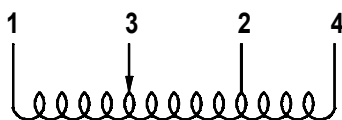

0.7 AMP

INPUT 240 V AT C-A OR C-B  
OUTPUT 0-240 OR 0-270 AT C-E

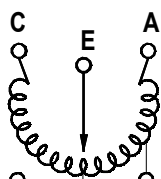

4 TO 28 AMP

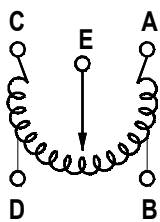

2 & 3 AMP

## CONNECTION ARRANGEMENT

1. Read all of these instructions before you use the transformer.
2. This transformer is not designed to provide mains isolation.
3. Variable transformers operate at mains voltage.  
**DO NOT EXCEED THE MAXIMUM VOLTAGE AND CURRENT RATING.**
4. Installation connection and maintenance should only be carried out by suitably qualified personnel.
5. When connected to the electrical supply the terminals, brushes and track face are at mains potential with a potentially lethal voltage.
6. The output from the transformer must always be applied across the load.  
Never connect the transformer in series with the load.
7. The carbon brush should be inspected for damage or wear, faulty or worn brushes will result in damage to the windings.
8. This transformer must be earthed using the earth studs provided
9. The E terminal is the output from the transformer and must not be earthed.
10. The transformer is Class 1 insulated and must not be tested on Portable Appliance Testers as Class 2 products.  
Flash test only at 2kV between the windings and earth.

Type	RS Part Code	Output Amps	A	B	C	D	E	H	Ø	Weight Kgs
WCV0.7E-1	8902799	0.7	125	96				120		3
WCV2E-1	8902793	2	160	130				160		3.8
WCV3E-1	8902803	3	160	130				160		4.5
WCV5E-1	8902806	5	175	175	146	146	35	140	10	8.7
WCV8E-1	8902800	8	175	175	146	146	35	170	10	8.7
WCV10E-1	8902819	10	175	175	146	146	35	170	10	9.2
WCV15E-1	8902812	15	225	225	176	176	40	190	11	16
WCV20E-1	8902816	20	225	225	176	176	40	190	11	18
WCV28E-1	8902825	28	300	300	238	238	70	225	13	26

Document Ref

**RS/SIVE**

Date  
REV1 June 2016

