

Multi-function Digital Time Relay 24-240Vac/dc (33 Functions):

RS STOCK NO.: 896-6872 & 896-6879

BASIC FEATURES:

- Contemporary look with 2x4 7-Segment Display.
- 33 Default Modes.
- Modes can be Customized as per user's requirement.
- Wide range of Applications with multiple Operating Modes.
- Wide Timing Range 0.1 s to 999 Days.
- User Friendly Keys & Key Operations with Lock & Unlock facility.
- Two Timers with Two separate Relay Outputs.
- Preset Time can be edit during Run Time.
- Modes can be saved & re-called through profiles P1 & P2.
- Wide Input Supply Range : 110-240V AC (Un) , -20% to +10% of Un
- Wide Signal Sensing Range: 85-265V AC/100-265V DC & 24-60V AC/DC.
- High Timing Accuracy.
- IP 30 Protection for front facial & Housing.
- Suitable for 48x48 Panel Mounting or Base Mounting/DIN/Socket.
- IEC 61812-1, CE, RoHS Compliance.



CAUTION:

- Always follow instructions stated in the Product Leaflet. Before installation, ensure that specifications agree with intended application.
- Installation must be done by skilled technician only.
- Automation device must be properly installed so that they are protected against any risk of involuntary actuations.
- Suitable dampers should be provided in event of excessive vibrations.
- Use of 250mA fuse in series with product supply is recommended.
- Do not touch the bleeder resistor when connected to the device as it can have high body temperature.

Note:

1. Using of AC 2 Wire Proximity Sensor (Input signal range- 85-265V AC):
Please add the input bleeder across signal input terminals to prevent false signal Sensing due to leakage current of proximity sensor. Generally suggested value of Bleeder is 22K, 5W (Included with the product as an accessory).

Connection for sensors:

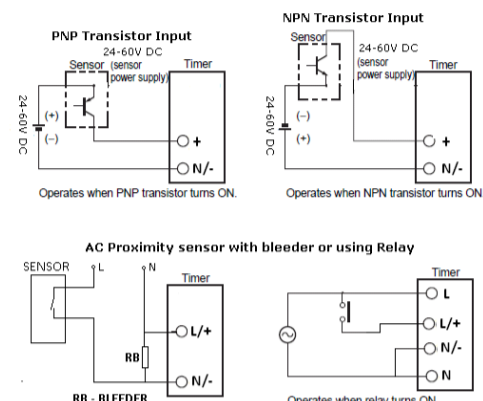

CONNECTION DIAGRAM:

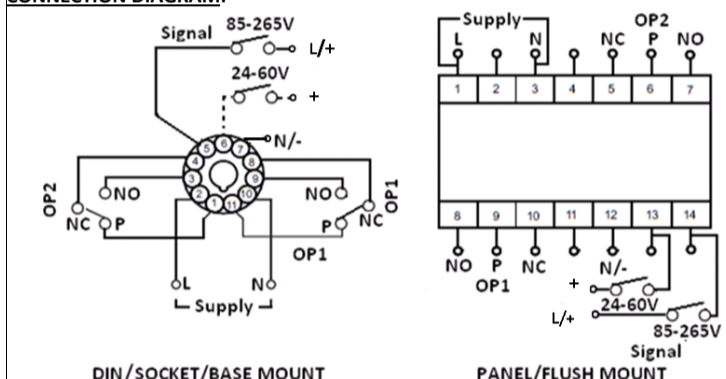

OVERALL DIMENSIONS:

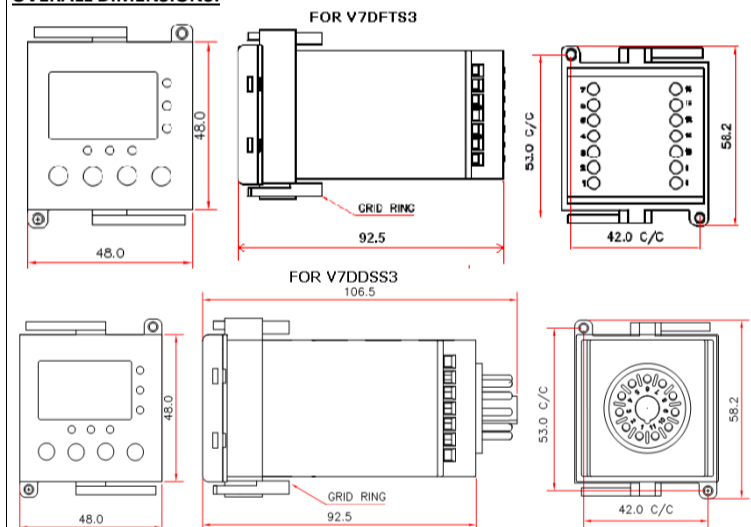

NOMENCLATURE FOR FRONT FACIA:

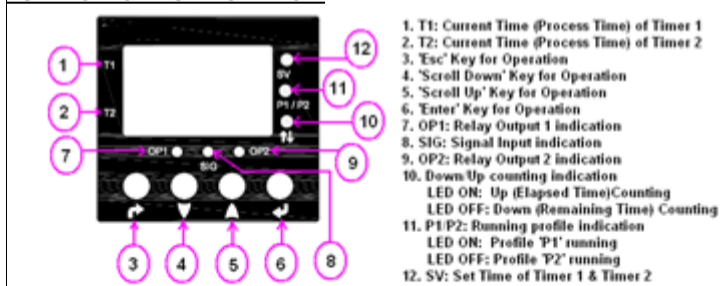

- T1: Current Time (Process Time) of Timer 1
- T2: Current Time (Process Time) of Timer 2
- 'Esc' Key for Operation
- 'Scroll Down' Key for Operation
- 'Scroll Up' Key for Operation
- 'Enter' Key for Operation
- OP1: Relay Output 1 indication
- SIG: Signal Input indication
- OP2: Relay Output 2 indication
- Down/Up counting indication
- LED ON: Up (Elapsed Time) Counting
- LED OFF: Down (Remaining Time) Counting
- P1/P2: Running profile indication
- LED ON: Profile 'P1' running
- LED OFF: Profile 'P2' running
- SV: Set Time of Timer 1 & Timer 2

Meaning of notations of first digit of Seven segment display during run time:

- n - Time running on the device is in Seconds scale.
- l - Time running on the device is in Minutes scale.
- c - Time running on the device is in Hours scale.
- r - Time running on the device is in Hours: Minute scale.
- u - Time running on the device is in Minutes: Second scale.
- d - Time running on the device is in Days scale.

Key Conventions:

- Long Press:** Key pressed for more than 3 sec.
- Short Press:** Key pressed for less than 3 sec.
- 'Enter' Key Long Pressed at power on - Program mode/Edit mode (with device version display).
- 'Enter' key short pressed in Program mode/Edit mode - Value/parameter entered & Move to next menu.
- 'Enter' short pressed during Run mode - Edit Preset Time during Timer Operation.
- 'ESC' key long pressed during Run mode - Program mode/Edit mode.
- 'ESC' key short pressed in Program mode - Return to previous menu.
- 'ESC' key short pressed in online edit - Device will come out of online editing
- 'ESC + Enter' long pressed run mode - lock / unlock.
- 'ESC + Up' key long pressed in run mode - Getting profile/Profile Recall & Run.
- 'Down' key long pressed in Run mode - Resets timer1.
- 'Down' Key short pressed in Online Program mode - Blinking preset digit gets decremented.
- 'UP' key long pressed in run mode - Resets timer 2 (if both timers are selected).
- 'UP' key short pressed during run mode - If both timers are configured then display will show Set value of both the timers for 2 sec. When only one timer is configured then it will have no effect on the screen.
- 'Up/down' short pressed in Program mode - Increment / Decrement the value/Parameter.
- 'Down + UP' key long pressed in run mode when both timers are selected - Reset the timer1 and timer2.

PRODUCT SPECIFICATIONS:

Abbreviations used on seven segment Display during Programming and

Abbreviation	Description
cnF9	Device Configuration - Timer1 or Both Timer 1 & 2.
tir 1	Timer 1 - Selection/Setting/Configuration.
tir 2	Timer 2 - Setting/Configuration.
both	Both Timer 1 & Timer 2 Selection/Setting/Configuration.
dEFt	Default Mode Configuration/Selection - User can select different default Modes for Timer1 & Timer2. There are 33 inbuilt default modes available.
CUSt	Customized Mode Configuration/Selection - User can build their own Mode/Profile as per their requirement by using menu selection.
l rLS	Initial relay status before signal status detection.
rLS	Relay Status after Power ON (For Non-signal based modes).
t nE	Do you want to keep Relay ON/OFF for specific timing?
S B or nS B	Signal Based or Non-signal Based Mode Selection in customized Mode.
SP or SA	Action to be taken on which signal transition - Signal Present/Signal Absent
rSP or rSA	Relay Status after transition of signal Present/Absent.
OFF	Relay OFF selection.
On	Relay ON selection.
onof	Relay ON-OFF cycle selection.
ofon	Relay OFF-ON cycle selection.
cont	Relay Continuously ON / OFF selection.
trAn or LEuL	Action to be taken on signal - transition or level
cyon	Number of cycles ON/OFF Cycles i.e. user can select the two cycles with different ON time & OFF time.
cyor	Cycle Repeat. Do you want repeat cycle? Select 'YES' or 'NO'.
dUrn	Action to be taken during ON time or OFF time or both for cyclic mode.
tdt 1	Do you want to take Action if the transition of signal occurs during timing before 'Action after time Completion' or relay state changeover? Here user can define the action to be taken if transition of the signal occurs during Run Time. Action can be taken on the SP or SA, user can take actions like 'Break'; 'Pause'; 'Reload'; 'Return' & 'Relay OFF'.
brER	Break: If Break condition is selected in trdt1: ATT action is started, there are four ATT actions Reload, Relay Off, New time and No. Action will be taken after signal changes its state. If break is applied no ATT is selected then toggle relay status and stop the cycle.
PAUS	Pause: Pause the timing on selected signal Present /Absent action.
rLad	Reload the timing: When this action is selected the Output is kept ON for the time same as previous one.
rEt	Stops the timing/mode operation without changing output state and wait for signal state to start the mode/timing operation once again.
rLoF	Stop the timing/mode operation with changing output state to OFF state and wait for signal state to start mode/timing operation once again.
Att	Action after time Completion, on opposite transition of signal i.e. if cycles starts on signal present then action for ATT is at signal absent.
tdt 2	Transition of the signal during Run Timing after 'Action after time Completion'. Here user can define the action to be taken if transition of the signal occurs during Run Time. Action can be taken on the SP or SA; user can take actions like 'No'; 'Reload'; 'New Time' & 'Relay OFF'.
nE't	New Time - When this action is selected the Output is kept ON for the NEW preset time. After completion of this ATT action the cycle is stopped.
rPtS	Repeat signal sensing or Cycle, after 1st cycle completion.
CUon	Counting: Time counting method selection.
UP	Up or Elapsed counting selection.
do'n	Down (Remaining) counting selection.
PrFL	Profile selection

How to configure the Device:

User can configure the device (Timer 1 or Both Timers) in either Default Mode or Customized Mode. Following are the examples of Operating Procedures to configure the device in Default or Customized mode.

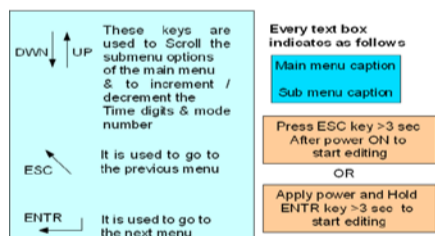

Example 16: IMPULSE ON ENERGIZING (Refer Mode No. 16 on page no. 02)

Select the Menu as given below to configure the Timers for IMPULSE ON ENERGIZING (Default).

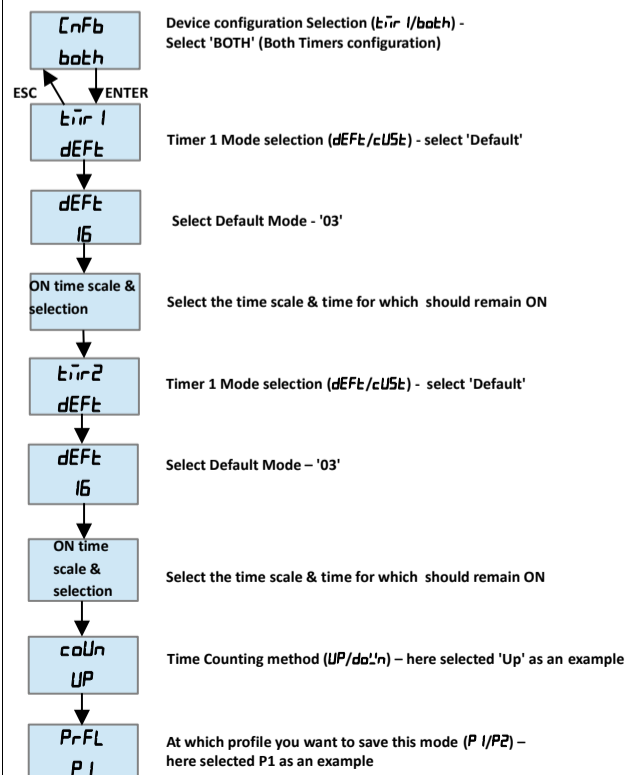

Example 2: SIGNAL ON/OFF DELAY TYPE 2 (Refer Mode No. 13 on page no. 02)

Select the Menu as given below to configure the Timers for SIGNAL ON/OFF TYPE 2 (Customized).

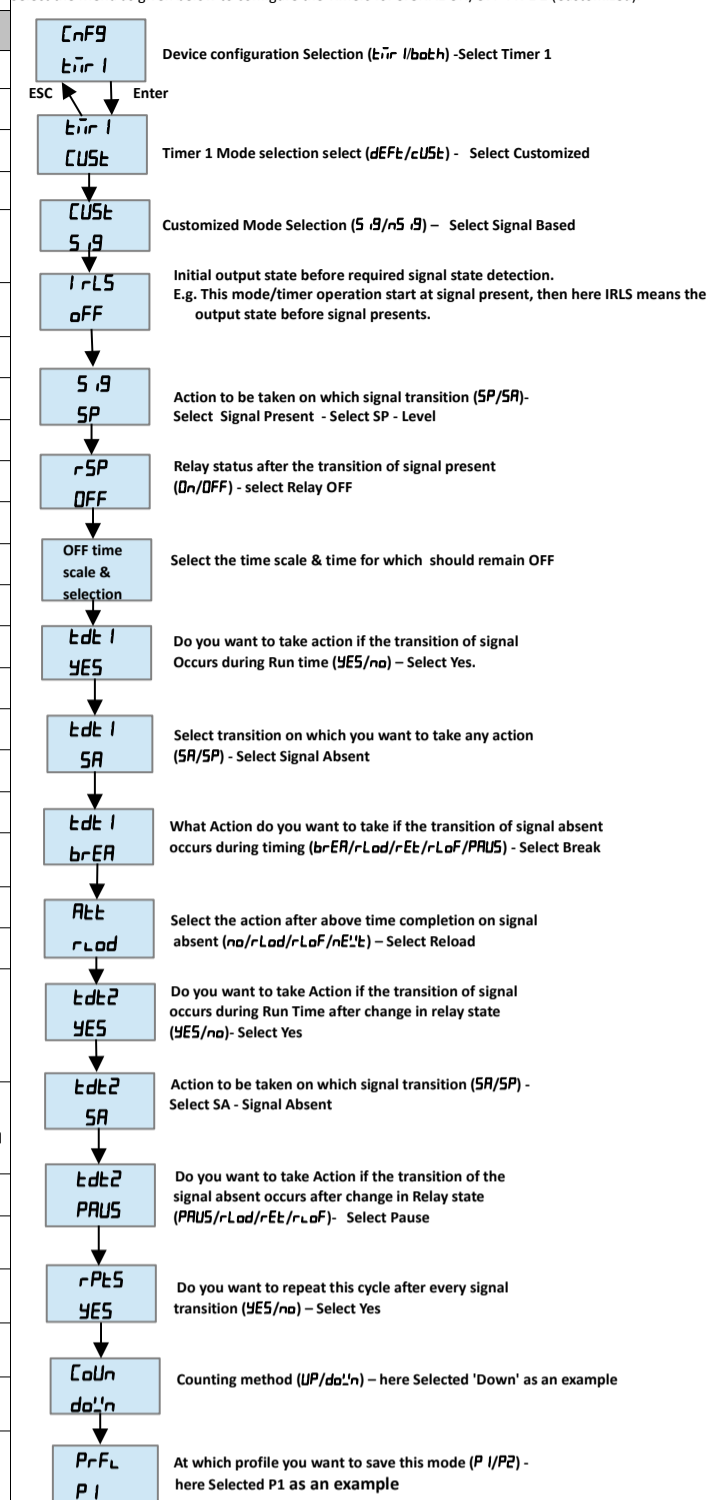

Example 2: ASYMMETRIC CYCLE PULSE START (Refer Mode No. 32 on page no. 02)

Select the Menu as given below to configure the Timers for ASYMMETRIC CYCLE PULSE START (Customized).

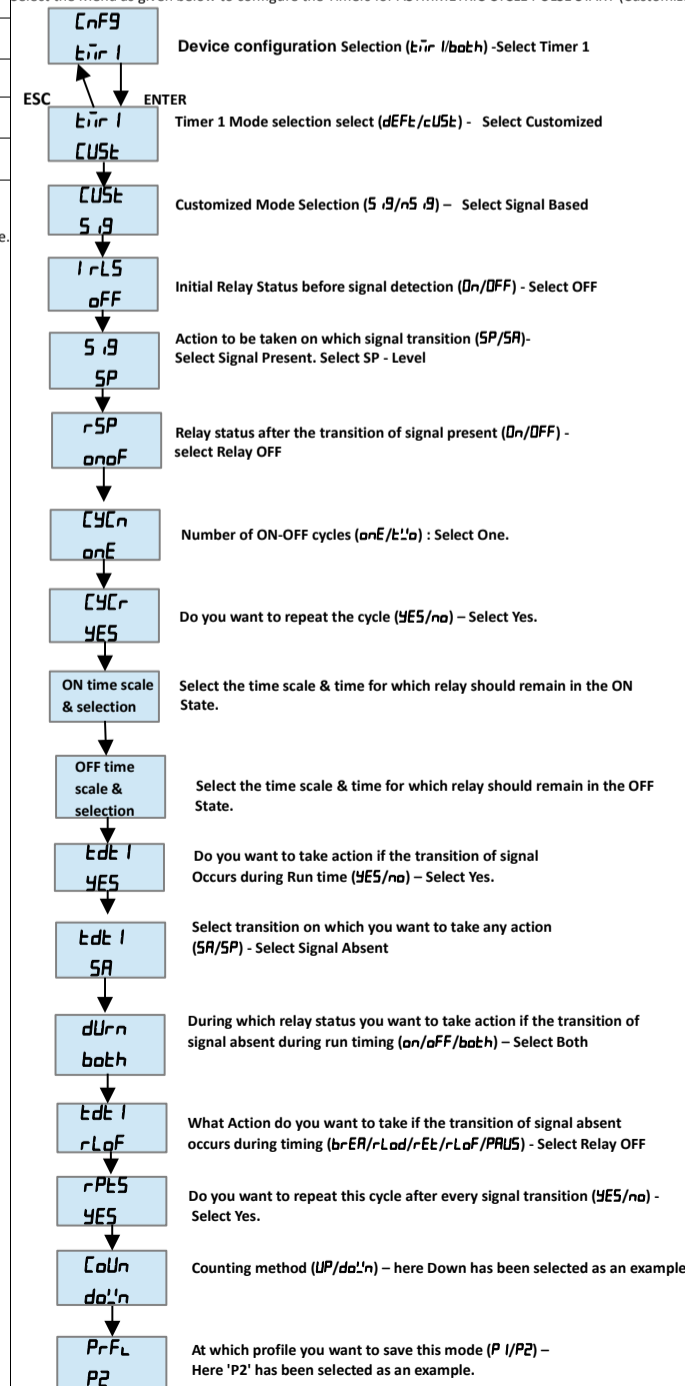

Parameter	Specifications
Supply Characteristics:	
Input Supply & Frequency Range	110-240V AC (Un) , -20% to +10% of Un, 47-63 Hz
Power Consumption	9 VA max.
Reset Time	< 200 ms @ Rated Supply for Both Relay ON condition.
Initiate Time	< 100 ms
Signal Characteristics:	
Input signals	High Range: 85-265V AC/ 100-265V DC, Low Range: 24-60V AC/DC
Signal Sensing Time	Guaranteed signal Present 50 ms. But for DC, signal present may get detected for 5 ms pulse.
Signal Wait period	100ms @ Power 'ON' & for signal based modes only
No. of Signal I/P & Signal Isolation	1 Isolated Signal , Signal Isolation - 2 KV
Relay Output Characteristics:	
Contact Rating	5A NO & 3A NC @250VAC/30VDC Resistive.
Utilization Category	AC 15: 250V AC/2A, Cos φ = 0.6, 85°C, 100000 Operations. DC 13: Ue rated voltage V – 24; Ie rated current A – 2.0.
Contact Material	Ag alloy (Cd free).
Mechanical Life Expectancy	5*10 ⁶ Operations.
Electrical Life expectancy	1*10 ⁵ Operations.
Switching Frequency	1800 Operations/hour.
Feature Characteristics:	
No. of Timers & No of Relay Outputs	2 Timers (Independent) & 2 Separate Relay Outputs.
No. of Default Modes	33 (Run Time Editable).
Customized Modes	Can be programmed as per customer requirement.
No. of Timing Profiles	2 profiles can be saved & Recall whenever required.
Timing Resolution	Day Day. Hrs. Hrs. Min
Timing Range	999 99.9 999 99.9 999
Timing Resolution	Min. Sec. Sec. Hr-Min Min-Sec
Timing Range	99.9 999 99.9 9.99 9.99
Timing Accuracy	+/- 0.01%
Factory Default Setting	Timer 1: On Delay 10 sec. Timer 2: On Delay 10 Sec.
Display	7-Segment 2x4 digit common cathode type.
Keypad	4 front key as Enter, Up, Down & Esc.
Key De-bounce Time	100 ms Max.
Time Counting Options	User Selectable: Elapsed Time (Up) or Remaining Time (Down).
LED Indications	SG (G) OP1 (R) OP2 (R) SV (R) P1/P2 (R) Up/Down (R) Signal Present Relay OP1 ON Relay OP2 ON Set Value Profile P1 Running Up Counting

Environmental Characteristics:	
Operating Temperature	-5 to +55° c
Storage Temperature	-10 to 60° c
Relative Humidity	5 to 95%
Operating Altitude	2000m
Enclosure Protection	IP 30 for Housing & front Facial and IP 20 for Terminals
Pollution Degree	II
Operating Position	Any

Mechanical Characteristics:	
Dimensions (W x H x D)	896-6872: 48 x 48 x 92.5 mm & 896-6879: 48 x 48 x 106.5
Mounting Type	896-6872 - Panel/Flush, 896-6879 – DIN/Base/Socket
Weight (Packed)	160gms Approx.
Panel Cut-out	45 x 45 mm
Enclosure Material	UL 94-V0







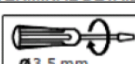
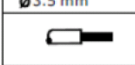



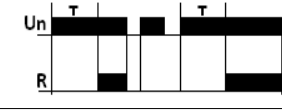
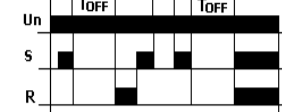

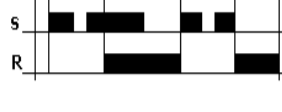
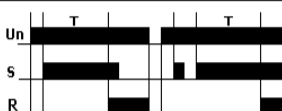
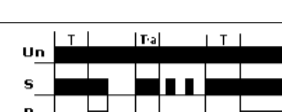
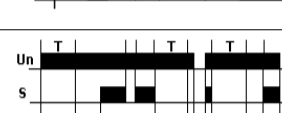
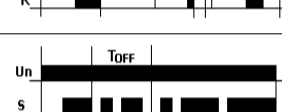
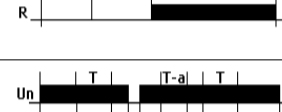
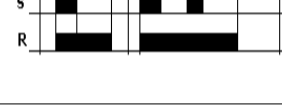
EMI/EMC Compliance:			
Test	Compliance Standard	Edition	Level
Harmonic Current Emission	IEC 61000-3-2	Ed. 3.0 (2005-11)	Class A
ESD Immunity	IEC 61000-4-2	Ed. 1.2 (2001-04)	II
Radiated Susceptibility	IEC 61000-4-3	Ed. 3.0 (2006-02)	III
Electrical Fast Transient (Power Ports & Signal Port)	IEC 61000-4-4	Ed. 2.0 (2004-07)	IV
Surge Immunity (Power Port)	IEC 61000-4-5	Ed. 2.0 (2005-11)	IV
Surge Immunity (Signal Port)	IEC 61000-4-5	Ed. 2.0 (2005-11)	III
Conducted Susceptibility	IEC 61000-4-6	Ed. 2.2 (2006-05)	III
Voltage Dips (AC)	IEC 61000-4-11	Ed. 2.0 (2004-03)	I, II, IV & V
Voltage Dips (DC) for Signal	IEC 61000-4-29	Ed. 2.0 (2004-03)	I & II
Conducted Emission	CISPR 14-1	Ed. 5.0 (2005-11)	Class A
Radiated Emission	CISPR 14-1	Ed. 5.0 (2005-11)	Class A

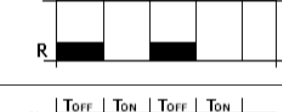
Safety Compliance:			
Test	Compliance Std.	Edition	Level
Test Voltage (I/P & O/P)	IEC 60947-5-1	Ed. 3.0 (2003-11)	2 KV
Test Voltage (All Terminals & Enclosure)	IEC 60255-5-1	Ed. 3.0 (2003-12)	4 KV
Single Fault	IEC 61010-1	Ed. 2.0 (2001-02)	-----
Insulation Resistance	UL 508	Ed. 17 (1999-01)	> 50 KΩ
Leakage Current	UL 508	Ed. 17 (1999-01)	< 3.5 mA

Environmental Compliance:			
Cold Heat	IEC 60068-2-1	Ed. 6.0 (2007-03)	-----
Dry Heat	IEC 60068-2-2	Ed. 5.0 (2007-07)	-----
Vibration	IEC 60068-2-6	Ed. 7.0 (2007-12)	5g
Repetitive Shock	IEC 60068-2-27	Ed. 4.0 (2008-02)	40g, 6 ms
Non-Repetitive Shock	IEC 60068-2-27	Ed. 4.0 (2008-02)	30g, 15 ms

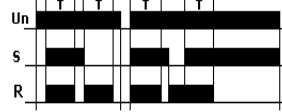
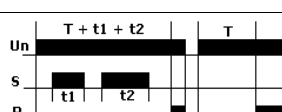
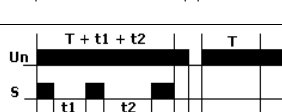
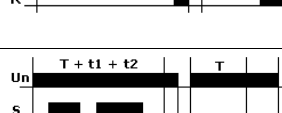
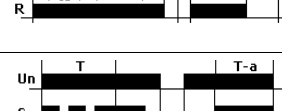
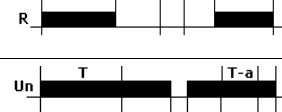
TERMINAL DETAILS:		
	0.5 N. m (3.5 Lb in) Terminal screw - M3	AWG CURRENT (A)
	1 x 0.12...2 mm ² Solid Wire	14 8
AWG	1 x 26 to 14	16 6.4
		18 4.8
		20 3.2
		22 1.6

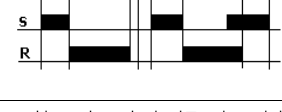
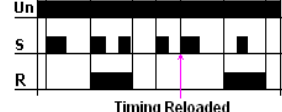
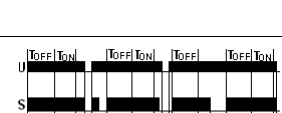
Use Cu wire of 75°C only.

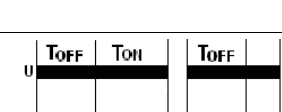
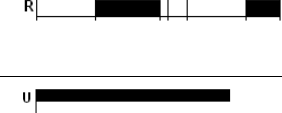
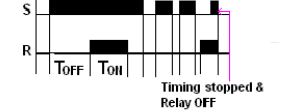
Operating Mode & Description	Timing Diagram
MODE - 00: ON DELAY On application of the supply voltage, the preset time duration (T) starts. On completion of the pre-set time, the output is switched ON & remains on till the supply voltage is present.	
MODE-01: ON DELAY CONSTANT SUPPLY TYPE 2 Timing will commence when the supply voltage is applied and input signal removed. After the time period has elapsed, output is switched ON. If signal is closed during the timing then the timing stops. Timing will restart only when signal is removed again. Therefore there are two methods this timer can be controlled, either by application or removal of signal input and with the interruption of the supply voltage to the timer with signal removal.	
MODE-02: ON DELAY CONSTANT SUPPLY TYPE 3 A permanent supply voltage is required. The timing period starts when the signal is closed and will continue irrespective of any further changes to signal input. After the time period has elapsed output is switched ON. Signal change has no effect during timing period. To reset the timer, signal must be removed and then closed once again.	
MODE-03: ON DELAY (CONTROL SWITCH RESETTABLE) When the supply voltage is applied and signal is closed, the timing function starts. If signal is removed and closed again during the preset timing then timing is restarted and output stays OFF. After preset time has elapsed the output is ON.	
MODE - 04: SIGNAL ON DELAY Time commences as supply voltage and signal is present. When input signal is opened, the timing resets. The output is switched ON at the end of the preset time duration (Toff). When output is ON if signal is opened then output switches OFF.	
MODE - 05: INVERTED SIGNAL ON DELAY When supply voltage is applied and if signal is opened then the preset time duration (Toff) starts. On preset time completion, the output is switched ON. If signal is closed during timing period, then timing stops and timing restarts when signal is removed.	
MODE - 06: INVERTED SIGNAL ON DELAY TYPE 2 When the supply voltage is applied and input signal is opened, the preset time duration (Toff) starts. After the time period has elapsed, the output is switched ON. Signal change has no effect during timing period. Output stays ON until supply voltage has been interrupted.	
MODE - 07: SIGNAL OFF DELAY When the supply voltage is applied & input signal closed, the output is switched ON. When the signal is opened the preset time duration commences & the output is switched OFF at the end of the preset time duration. If signal is closed during timing period, then timing stops and timing restarts when signal is opened again.	
MODE-08: OFF DELAY CONST. SUPPLYTYPE 2 A permanent supply voltage is required. When the input signal is closed the output is switched ON immediately. When input signal is removed the timing period starts. After the time period has elapsed output is switched OFF. Once the timing period has started further changes in the input signal will have no effect. However once the timing cycle has been completed the process may be started again by closing input signal. While the timer is executing the only way to reset the timer is to interrupt the supply.	
MODE - 09: CYCLIC ON/OFF On application of supply voltage, the output is initially switched ON for the preset 'ON' time duration (Ton) after which it is switched OFF for the preset 'OFF' time duration (Toff). This Cycle repeats and continues till supply is present.	
MODE - 10: CYCLIC OFF/ON On application of supply voltage, the output is initially switched OFF for the preset 'OFF' time duration (Toff), after which it is switched ON for the preset 'ON' time duration (Ton). This Cycle repeats and continues till supply is present.	
MODE-11: ASYMMETRIC CYCLE PULSE START A permanent supply voltage is required. The timer function is triggered by the input signal. When input signal closed the output is switched ON while the first preset time period (Ton) elapses. Once this time period (Ton) has elapsed output is switched OFF for the second preset time period (Toff) period. Once this second time period (Toff) had elapsed then output switched ON and the cycle will start from the beginning again. If input signal is opened during timing (Ton or Toff) the cycle will stop and output is switched OFF, cycle will start with output ON state when the input signal closed again.	
MODE-12: ASYMMETRIC RECycler PULSE START TYPE 2 A permanent supply voltage is required. The timer function is triggered by input signal. When input signal is closed the output is switched OFF while the first preset time period (Toff) elapses. Once this time period has elapsed output is switched ON for the second preset time period (Ton). Once this second time period (Ton) had elapsed then output is switched OFF and the cycle will start from the beginning again. If input signal is opened during timing (Ton or Toff) the cycle will stop and output is switched OFF, cycle will start with output OFF state when the input signal closed again.	
MODE - 13: SIGNAL ON OFF DELAY On application of signal the preset time (T) starts. After this preset time has elapsed, output is switched ON. During this timing, if signal is opened then output is switched ON immediately and OFF delay is started. Once this time period has elapsed the output is switched OFF. During this OFF delay if signal is closed again the output switched OFF immediately and ON Delay restarted.	
MODE -14: SIGNAL ON OFF DELAY TYPE 1 On application of supply voltage & input signal the preset time (T) starts. After this preset time has elapsed, output is switched ON. During this timing, if signal is opened then output is switched ON immediately and OFF delay is started. Once this time period has elapsed the output is switched OFF. During this OFF delay if signal is closed again the output switched OFF immediately and ON Delay restarted.	
MODE - 15: SIGNAL ON/OFF Type 2 On application of input signal, the preset delay time period (T) starts. During this timing if signal is removed then timing is stopped and timing will be restarted when signal applied again. After this time period has elapsed output is switched ON. On removal of input signal, the preset time period starts again & the output is switched OFF when the preset time duration is complete. Output stays OFF until supply voltage has been interrupted.	
MODE - 16: IMPULSE ON ENERGIZING On application of supply voltage, the output is instantly switched ON for the preset time duration (Ton) after it is switched OFF.	
MODE - 17: IMPULSE ON/OFF When supply voltage is applied and on closing or opening of input signal, the output is switched ON & the preset time duration starts. On completion of the time duration the output is switched OFF. During timing period, changing the state of the input signal does not affect output but resets time.	
MODE - 18: ACCUMULATIVE DELAY ON SIGNAL On application of supply voltage, the preset timing duration commences. When input signal is closed, the timing pauses & resumes only when the input signal is opened. The output is switched ON at the end of the preset time duration (Toff).	
MODE - 19: ACCUMULATIVE DELAY ON INVERTED SIGNAL Time commences as supply voltage is applied and signal is closed. When input signal is opened, the timing pauses & resumes only when the input signal is closed again. The output is switched ON at the end of the preset time duration.	
MODE - 20: ACCUMULATIVE IMPULSE ON SIGNAL On application of supply voltage, the output is switched ON & the preset timing duration commences. When input signal is closed, the timing pauses & resumes only when the input signal is opened. The output is switched OFF at the end of the preset duration (Ton).	
MODE - 21: LEADING EDGE IMPULSE On application of supply voltage & input signal, the output is switched ON for preset time. After completion of preset time period, output is switched OFF. If the input signal is applied or opened during preset timing period, the output and timing remains unaffected.	
MODE - 22: LEADING EDGE IMPULSE 2 On application of the input signal the output is immediately switched ON. The output remains ON for the preset time duration (T) after which it is switched OFF. If the input signal is opened during the pre-set time, the output immediately switched OFF.	
MODE - 23: TRAILING EDGE IMPULSE When the supply voltage is applied and input signal is opened, the output is switched ON for the preset time duration (T). After completion of preset time period, output is switched OFF. If I/P signal is closed during the preset timing period then output is switched OFF & timing stops.	
MODE - 24: TRAILING EDGE IMPULSE 2 When the input signal to the timer is opened, the output is immediately switched ON for the preset time duration (Ton) after which it is switched OFF. If the input signal is closed during the pre-set time, the output remains unaffected.	
MODE - 25: DELAYED IMPULSE On application of supply and input signal, the preset 'OFF' time duration (Toff) starts. The output is switched ON at the end of preset 'OFF' time duration. Then the preset 'ON' time starts irrespective of the signal state & ON till the completion of 'Ton'. During the output OFF period if signal is closed then timing is restarted, but output is unaffected. The signal change has no effect during time period (Ton).	
MODE-26: DELAYED IMPULSE TYPE 2 A permanent supply is required. When signal is closed the output will remain OFF while the first preset time period (Toff) elapses. Once this time period has elapsed the output is switched ON for the second preset time period (Ton). Once this second time period (Ton) had elapsed then output is switched OFF and cycle stops. Output stays OFF until supply voltage has been interrupted. During timing period (Ton or Toff) if signal is opened then output is switched OFF and the cycle stops, cycle will start with output OFF state when the input signal closed again.	
MODE-27: DELAYED PULSE (CONSTANT SUPPLY) POWER BASED The timing period (Toff) starts when the supply is applied to the timer. After the preset has elapsed output is switched ON for the preset pulse (Ton) duration. To reset the timer the supply has to be interrupted. If this interruption occurs during the pulsed output (Ton) then the output is switched OFF and the timer will reset.	
MODE-28: DELAYED PULSE (REMOTE TRIG.) The timing period (Toff) will start when input signal is closed with the supply connected. After preset time (Toff) has elapsed the output is switched ON for the pre-selected pulse (Ton) duration. To reset the timer either input signal needs to be removed or supply has to be interrupted. If this action occurs during the pulsed output cycle (Ton) then output is switched OFF and the timer will reset.	
MODE-29: DELAYED PULSE (CONST. SUPPLY TYPE 1) Supply to the unit must be continuous. On application of input signal the time period 'Toff' starts to run. On completion of 'Toff', the relay output is switched ON immediately and the time period 'Ton' starts to run. On completion of 'Ton' the output is switched OFF. The input signal has no effect until 'Toff' or 'Ton' have completely expired.	
MODE-30: ON PULSE (CONTROL SWITCH RESETTABLE)/ WATCH DOG TYPE When the supply is connected and signal is applied, output is switched ON and the timing function starts. If signal is removed and applied during the preset timing then timing is restarted and output stays ON. After preset time (Ton) has elapsed the output is switched OFF	
MODE - 31: ON PULSE (SUPPLY RESET) On application of supply voltage the output is switched ON. The first pulse of input signal starts the preset time period. Receiving pulses during the time period extends it and output stays ON. Receiving no signal pulses during the time period completes it and output is switched OFF. Output stays OFF until supply voltage has been interrupted.	
MODE - 32: Leading Edge Bi-stable or Step Relay After every signal, the output contact changes their states, alternately switching from open to close & vice versa. Important Note: As per the timing diagram this mode is not time base mode, hence ideally there is no need to enter the time. But if we have select action on Signal present as relay ON continuously, then as per flow chart of the TDT2 (Action on Transition during Run Time) will not be shown. So select relay on time maximum i.e. 999 Days. Timeout: 1. If user is in Program mode or in Profile selection, & there is no any single key press event for 2 min. Then device will RUN with previous settings (Restart the Operation). 2. If user is in Preset Time Edit mode during Run Time & there is no any single key press event for 2 min. Then device will RUN with previous settings (Resume the Operation) Preset Time/Set Value: The Time duration selected or entered by the user. Run Time/Current Time/Process Value: This is the running time on the device. In down counting mode it indicates the remaining time of Preset Time and in Up counting it indicates the elapsed time.	