



# Automotive Audio Bus A<sup>2</sup>B Transceiver

## AD2420(W)/AD2426(W)/AD2427(W)/AD2428(W)/AD2429(W)

### A<sup>2</sup>B BUS FEATURES

#### Line topology

Single master, multiple slave

Up to 15 m between nodes and up to 40 m overall cable length (see [Table 9](#))

#### Communication over distance

Synchronous data

Multichannel I<sup>2</sup>S/TDM to I<sup>2</sup>S/TDM

Synchronous clock, phase aligned in all nodes

Low latency slave to slave communication

Control and status information I<sup>2</sup>C to I<sup>2</sup>C

GPIO and interrupt

Bus power or local power slave nodes

Configurable with SigmaStudio graphical software tool

AEC-Q100 qualified for automotive applications

### A<sup>2</sup>B TRANSCEIVER FEATURES

Configurable A<sup>2</sup>B bus master or slave operation  
I<sup>2</sup>C interface

8-bit to 32-bit multichannel I<sup>2</sup>S/TDM interface

Programmable I<sup>2</sup>S/TDM data rate

Up to 32 upstream and 32 downstream channels

PDM interface

Programmable PDM clock rate

Up to 4 high dynamic range microphone inputs

Simultaneous reception of I<sup>2</sup>S data with up to 4 PDM microphones

Unique ID register for each transceiver

Crossover or straight-through cabling

Programmable settings to optimize EMC performance

### APPLICATIONS

Audio communication link

Microphone arrays

Beamforming

Hands free and in car communication

Active and road noise cancellation

Audio/video conferencing systems

#### Product Status

Product	Status	Product	Status
<a href="#">AD2420</a>	Pending	<a href="#">AD2427W</a>	Available
<a href="#">AD2420W</a>	Pending	<a href="#">AD2428</a>	Pending
<a href="#">AD2426</a>	Pending	<a href="#">AD2428W</a>	Available
<a href="#">AD2426W</a>	Available	<a href="#">AD2429</a>	Pending
<a href="#">AD2427</a>	Pending	<a href="#">AD2429W</a>	Pending

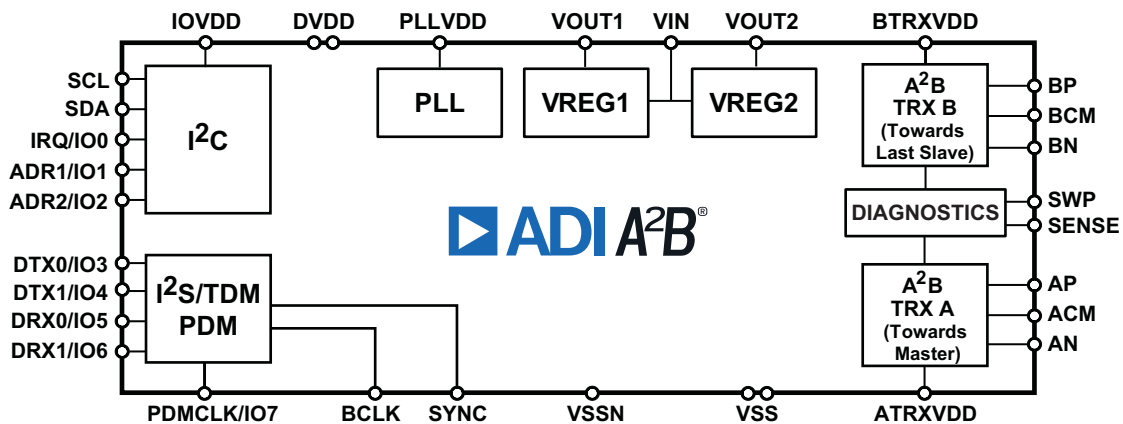

Figure 1. Functional Block Diagram

A<sup>2</sup>B and the A<sup>2</sup>B logo are registered trademarks of Analog Devices, Inc.

#### Rev. A

#### Document Feedback

Information furnished by Analog Devices is believed to be accurate and reliable. However, no responsibility is assumed by Analog Devices for its use, nor for any infringements of patents or other rights of third parties that may result from its use. Specifications subject to change without notice. No license is granted by implication or otherwise under any patent or patent rights of Analog Devices. Trademarks and registered trademarks are the property of their respective owners.

One Technology Way, P.O. Box 9106, Norwood, MA 02062-9106 U.S.A.  
Tel: 781.329.4700 ©2019 Analog Devices, Inc. All rights reserved.  
[Technical Support](#) [www.analog.com](http://www.analog.com)

## TABLE OF CONTENTS

A <sup>2</sup> B Bus Features .....	1	Test Circuits and Switching Characteristics .....	21
A <sup>2</sup> B Transceiver Features .....	1	Output Drive Currents .....	21
Applications .....	1	Test Conditions .....	22
Table of Contents .....	2	Pin Configuration and Function Descriptions .....	24
Revision History .....	2	Power Analysis .....	28
General Description .....	3	Current Flow .....	28
A <sup>2</sup> B Bus Details .....	4	VREG1 and VREG2 Output Currents .....	29
I <sup>2</sup> C Interface .....	5	Current at VIN (IVIN) .....	30
I <sup>2</sup> S/TDM Interface .....	5	Power Dissipation .....	30
Pulse Density Modulation (PDM) Interface .....	6	Resistance Between Nodes .....	30
GPIO Over Distance .....	6	Voltage Regulator Current in Master Node or Local Powered Slave Node .....	31
Mailboxes .....	6	Power Dissipation of A <sup>2</sup> B Bus .....	31
Data Slot Exchange Between Slaves .....	6	Power Analysis of Bus Powered System .....	31
Clock Sustain State .....	6	Supply Voltage .....	31
Programmable Settings to Optimize EMC Performance .....	6	Reducing Power Consumption .....	32
Specifications .....	8	Thermal Power .....	32
Operating Conditions .....	8	Designer Reference .....	33
Electrical Characteristics .....	9	VSENSE and Considerations for Diodes .....	33
Power Supply Rejection Ratio (PSRR) .....	11	Optional Add On Circuits .....	33
Timing Specifications .....	12	Layout Guidelines .....	34
Power-Up Sequencing Restrictions .....	16	Outline Dimensions .....	36
A <sup>2</sup> B Bus System Specification .....	17	Ordering Guide .....	38
PDM Typical Performance Characteristics .....	18	Automotive Products .....	38
Absolute Maximum Ratings .....	20	Pending Products .....	39
Thermal Characteristics .....	20		
ESD Caution .....	21		

## REVISION HISTORY

10/2019—Revision A: Initial Version

## GENERAL DESCRIPTION

This product data sheet describes ten Automotive Audio Bus (A<sup>2</sup>B<sup>®</sup>) transceivers. Those appearing in gray text are unreleased models (AD2420, AD2420W, AD2426, AD2427, AD2428, AD2429, and AD2429W), whereas those appearing in black text are released models (AD2426W, AD2427W, and AD2428W).

A<sup>2</sup>B provides a multichannel, I<sup>2</sup>S/TDM link over distances of up to 15 m between nodes. It embeds bidirectional synchronous pulse-code modulation (PCM) data (for example, digital audio), clock, and synchronization signals onto a single differential wire pair. A<sup>2</sup>B supports a direct point to point connection and allows multiple, daisy-chained nodes at different locations to contribute and/or consume time division multiplexed (TDM) channel content.

A<sup>2</sup>B is a single-master, multiple-slave system where the transceiver at the host controller is the master. The master generates clock, synchronization, and framing for all slave nodes. The master A<sup>2</sup>B transceiver is programmable over a control port (I<sup>2</sup>C) for configuration and read back. An extension of the con-

trol port protocol is embedded in the A<sup>2</sup>B data stream, which grants direct access of registers and status information on slave transceivers as well as I<sup>2</sup>C to I<sup>2</sup>C communication over distance.

The transceiver can connect directly to general-purpose digital signal processors (DSPs), field-programmable gate arrays (FPGAs), application specific integrated circuits (ASICs), microphones, analog-to-digital converters (ADCs), digital-to-analog converters (DACs), and codecs through a multichannel I<sup>2</sup>S/TDM interface. It also provides a pulse density modulation (PDM) interface for direct connection of up to four PDM digital microphones.

Finally, the transceiver also supports an A<sup>2</sup>B bus powering feature, where the master node supplies voltage and current to the slave nodes over the same daisy-chained, twisted pair wire cable as used for the communication link.

**Table 1. Product Comparison Guide**

Feature	AD2420/ AD2420W	AD2426/ AD2426W	AD2427/ AD2427W	AD2428/ AD2428W	AD2429/ AD2429W
Master capable	No	No	No	Yes	Yes
Number of slaves discoverable <sup>1</sup>	N/A	N/A	N/A	Up to 10	Up to 2
Functional TRX blocks	A only	A only	A + B	A + B	B only
I <sup>2</sup> S/TDM support	No	No	No	Yes	Yes
PDM microphone inputs	2 mics <sup>2</sup>	4 mics	4 mics	4 mics	4 mics
Max node to node cable length	5 m	15 m	15 m	15 m	5 m

<sup>1</sup> N/A means not applicable.

<sup>2</sup> PDM microphones must be connected to the DRX0/IO5 pin.

## A<sup>2</sup>B BUS DETAILS

Figure 2 shows a single-master, multiple-slave A<sup>2</sup>B communications system with the master transceiver controlled by the host. The host generates a periodic synchronization signal on the I<sup>2</sup>S/TDM interface at a fixed frequency (typically 48 kHz) to which all A<sup>2</sup>B nodes synchronize.

Communications along the A<sup>2</sup>B bus occur in periodic superframes. The superframe frequency is the same as the synchronization signal frequency, and data is transferred at a bit rate that is 1024 times faster (typically 49.152 MHz). Each superframe is divided into periods of downstream transmission, upstream transmission, and no transmission (where the bus is not driven). Data is exchanged over the A<sup>2</sup>B bus in up to 32 equal width slots for both upstream and downstream transmissions.

The A<sup>2</sup>B bus also communicates the following control and status information between nodes:

- I<sup>2</sup>C to I<sup>2</sup>C communication
- General-purpose input/output (GPIO)
- Interrupts

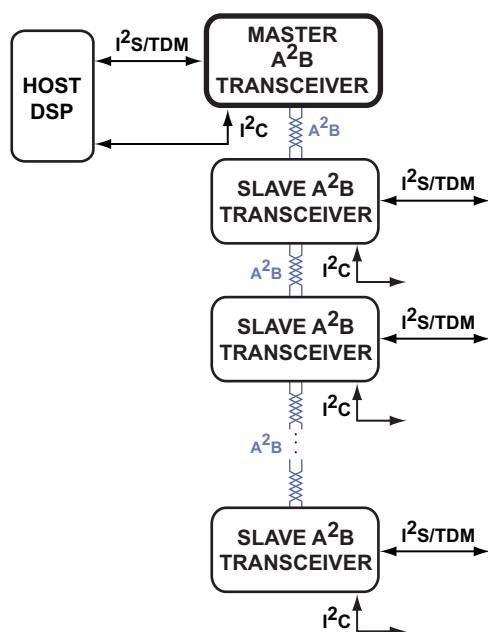

Figure 2. Communication System Block Diagram

In Figure 3, a superframe is shown with an initial period of downstream transmission and a later period of upstream transmission.

All signals on the A<sup>2</sup>B bus are line coded, and the master node forwards the synchronization signal downstream from the master transceiver to the last slave node transceiver in the form of a synchronization preamble. This preamble is followed by control data to build a synchronization control frame (SCF). Downstream, TDM synchronous data is added directly after the

control frame. Every slave can use or consume some of the downstream data and add data for downstream nodes. The last slave node transceiver responds after the response time with a synchronization response frame (SRF). Upstream synchronous data is added by each node directly after the response frame. Each node can also use or consume upstream data.

The embedded control and response frames allow the host to individually address each slave transceiver in the system. The host also enables access to remote peripheral devices that are connected to the slave transceivers via the I<sup>2</sup>C or SPI ports for I<sup>2</sup>C to I<sup>2</sup>C communication over distance between multiple nodes.

All nodes in an A<sup>2</sup>B system are sampled synchronously in the same A<sup>2</sup>B superframe. Synchronous I<sup>2</sup>S/TDM downstream data from the master arrives at all slaves in the same A<sup>2</sup>B superframe, and the upstream audio data of every node arrives synchronously in the same I<sup>2</sup>S/TDM frame at the master. The remaining audio phase differences between slaves can be compensated for by register-programmable fine adjustment of the SYNC pin signal delay.

There is a sample delay incurred for data moving between the A<sup>2</sup>B bus and the I<sup>2</sup>S/TDM interfaces because data is received and transmitted over the I<sup>2</sup>S/TDM every sample period (typically 48 kHz). This timing relationship between samples over the A<sup>2</sup>B bus is shown in Figure 4.

Note in Figure 4, both downstream and upstream samples are named for the frame where they enter the A<sup>2</sup>B system as follows:

- Data transmitted by the master node transceiver in Superframe M creates Downstream Data M.
- Data transmitted by the slave node transceivers in Superframe N creates Upstream Data N.
- Data received over the I<sup>2</sup>S/TDM interface by the A<sup>2</sup>B transceiver is transmitted over the A<sup>2</sup>B bus in the next superframe.
- Data on the A<sup>2</sup>B bus is transmitted over the I<sup>2</sup>S/TDM interface of an A<sup>2</sup>B transceiver in the next superframe.
- Data transmitted across the A<sup>2</sup>B bus (master to slave or slave to master) has two frames of latency plus any internal delay that has accumulated in the transceivers as well as delays due to wire length. Therefore, overall latency is slightly over two samples (<50 μs at 48 kHz sample periods) from the I<sup>2</sup>S/TDM interface in one A<sup>2</sup>B transceiver to the I<sup>2</sup>S/TDM interface of another A<sup>2</sup>B transceiver.

To support and extend the A<sup>2</sup>B bus functions and performance, the transceivers have additional features, as described in the following sections.

# AD2420(W)/AD2426(W)/AD2427(W)/AD2428(W)/AD2429(W)

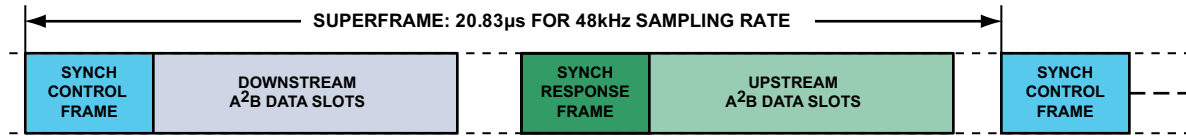

Figure 3. A<sup>2</sup>B Superframe

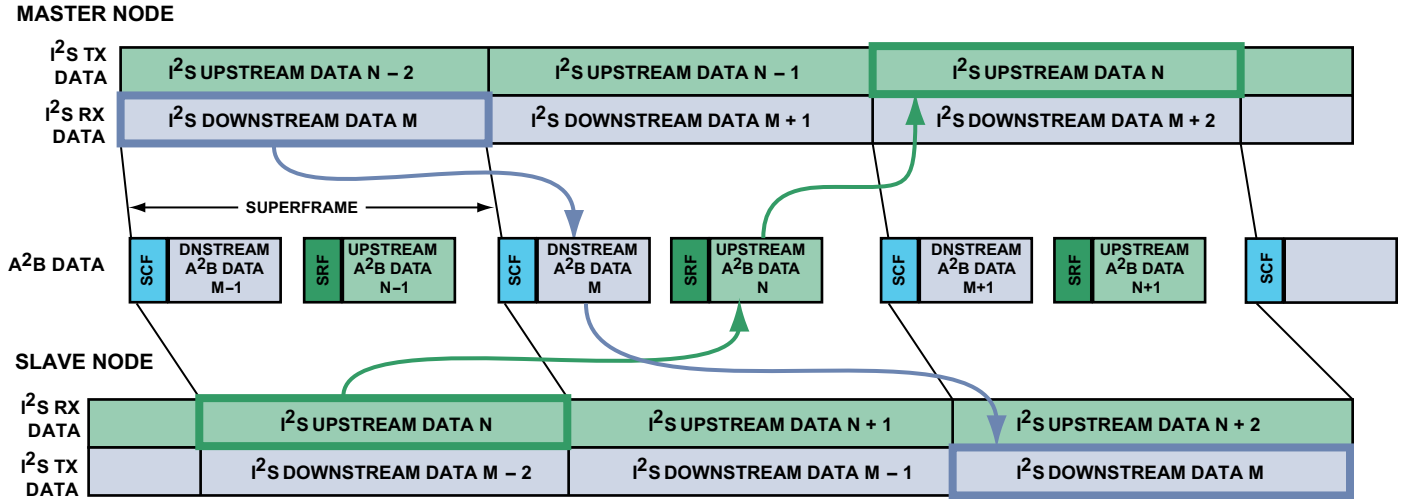

Figure 4. A<sup>2</sup>B Bus Synchronous Data Exchange

## I<sup>2</sup>C INTERFACE

The I<sup>2</sup>C interface in the transceiver provides access to the internal registers. Operation is not guaranteed above the  $V_{I2C\_VBUS}$  specification. The I<sup>2</sup>C interface has the following features:

- Slave functionality in the A<sup>2</sup>B master
- Master or slave functionality in the A<sup>2</sup>B slave
- Multimaster support in the A<sup>2</sup>B slave
- 100 kbps or 400 kbps rate operation
- 7-bit addressing
- Single-word and burst mode read and write operations
- Clock stretching

All transceivers can be accessed by a locally connected processor using the 7-bit I<sup>2</sup>C device address (BASE\_ADDR) established by the logic levels applied to the ADR2/IO2 and ADR1/IO1 pins at power-on reset, thus providing for up to four master devices connecting to the same I<sup>2</sup>C bus. A slave configured transceiver recognizes only this I<sup>2</sup>C device address. A master configured transceiver, however, also recognizes a second I<sup>2</sup>C device address for remote access to slave nodes over the A<sup>2</sup>B bus (BUS\_ADDR). The least significant bit (LSB) of the 7-bit device address determines whether an I<sup>2</sup>C data exchange uses the BASE\_ADDR (Bit 1 = 0) to access the transceiver or BUS\_ADDR (Bit 1 = 1) to access a bus node slave transceiver

through a master configured AD2425W transceiver. See the *AD2420(W)/6(W)/7(W)/8(W)/9(W) Automotive Audio Bus A<sup>2</sup>B Transceiver Technical Reference* for details.

## I<sup>2</sup>S/TDM INTERFACE

The I<sup>2</sup>S/TDM serial port operates in full-duplex mode, where both the transmitter and receiver operate simultaneously using the same critical timing bit clock (BCLK) and synchronization (SYNC) pins. A<sup>2</sup>B slave transceivers generate the timing signals on the BCLK and SYNC output pins. A<sup>2</sup>B master transceivers use the same BCLK and SYNC pins as inputs, which are driven by the host device. The I<sup>2</sup>S/TDM port includes the following features:

- Programmable clock and frame sync timing and polarity
- Numerous TDM operating modes
- 16- or 32-bit data width
- Simultaneous operation with PDM port
- Single- or dual-pin input/out (I/O)

### I<sup>2</sup>S Reduced Rate

Slave transceivers can run the I<sup>2</sup>S/TDM/PDM interface at a reduced rate frequency, with respect to the superframe rate. The reduced rate frequency is derived by dividing the superframe rate from a programmable set of values. Different slave nodes can be configured to run at different reduced I<sup>2</sup>S/TDM rates.

The transceiver provides an option for a processor to track the full rate audio frame, which contains new reduced rate samples. The IO7 pin can be used as a strobe, and the direction can be configured as an input or output.

### PULSE DENSITY MODULATION (PDM) INTERFACE

The PDM block on the transceiver converts a PDM input stream into pulse code modulated (PCM) data to be sent over the A<sup>2</sup>B bus and/or out to the local node through the I<sup>2</sup>S/TDM port. It supports high dynamic range microphones with high signal-to-noise ratio (SNR) and extended maximum sound pressure level. The PDM interface supports 12 kHz and 24 kHz frame rates in addition to a 48 kHz frame rate and can be used on both master and slave transceivers.

Even lower PDM sampling rates (for example, down to 375 Hz) are possible in combination with the reduced rate feature of the transceiver. The cutoff frequency of the high-pass filter in the transceiver PDM block is fixed to 1 Hz.

BCLK can be used to clock PDM microphones on a slave, but if PDMCLK/IO7 is used instead, the BCLK frequency can be set to a different frequency using the I<sup>2</sup>S/TDM registers. In this case, PDMCLK/IO7 is used as the PDM clock (PDMCLK) to capture PDM input on DRX0/DRX1. The clock rate from PDMCLK is 64× the SYNC frequency.

On a master node, BCLK is always an input, so the clock to PDM microphones that are attached to a master typically comes from PDMCLK/IO7. It is possible to use BCLK to drive the PDM clock inputs on a master node, but this restricts the possible TDM settings because BCLK is required to fall within the  $f_{\text{BCLK}}$  specification in [Table 4](#).

BCLK and PDMCLK/IO7 can also be used concurrently to clock PDM microphones at the same frequency and phase alignment, but with opposite polarity. Additionally, a register setting selects whether rising edge data or falling edge data is sampled first.

### GPIO OVER DISTANCE

The transceiver supports general-purpose input/output (GPIO) between multiple nodes without host intervention after initial programming. The host is required only for initial setup of the GPIO bus ports. I/O pins of different nodes can be logically OR or AND gate combined.

### MAILBOXES

The transceiver supports interrupt driven, bidirectional message exchange between I<sup>2</sup>C master devices (microcontrollers) at different slave nodes and the host connected to the master node transceiver in two dedicated mailboxes. The mailboxes can be used to customize handshaking among numerous nodes in a system to coordinate system events, such as synchronizing audio.

### DATA SLOT EXCHANGE BETWEEN SLAVES

Using the DTX0 and DTX1 pins, slave transceivers can selectively output upstream or downstream data that originates from other nodes without the need for data slots to be routed through

the master node. Receive data channels can be skipped based on a programmable offset, when the data is presented as upstream or downstream slots to the A<sup>2</sup>B bus.

### CLOCK SUSTAIN STATE

In the clock sustain state, audio signals of locally powered slave nodes are attenuated in the event of lost bus communication. When the bus loses communication and a reliable clock cannot be recovered by the slave node, the slave node transceiver enters the sustain state and, if enabled, signals this event to a GPIO pin.

In the clock sustain state, the phase-locked loop (PLL) of the slave node transceiver continues to run for 1024 SYNC periods, while attenuating the I<sup>2</sup>S DTX0 to DTX1 data from the current value to 0. After the 1024 SYNC periods, the slave node transceiver resets and reenters the power-up state.

### PROGRAMMABLE SETTINGS TO OPTIMIZE EMC PERFORMANCE

The following programmable features can be used to improve electromagnetic compatibility (EMC) performance.

#### *Programmable LVDS Transmit Levels*

The low voltage differential signal (LVDS) transmitter can be set to transmit the signal at high, medium, or low levels. Higher transmit levels yield greater immunity to EMI, whereas lower transmit levels can reduce emissions from the twisted-pair cables that link A<sup>2</sup>B bus nodes together. The improved LVDS receiver (compared to other members of the AD242xW family) maintains robust operation when transmit levels are lowered.

#### *Spread-Spectrum Clocking*

Spread-spectrum clocking can be used to reduce narrow-band emissions on a printed circuit board (PCB). Spread-spectrum clocking is disabled on the transceiver by default, but spread-spectrum clocking for all internal clocks can be enabled during discovery by a register write.

If spread-spectrum clocking support is enabled for the internal clocks, spread-spectrum clocking can also be enabled for both the I<sup>2</sup>S interface and the programmed CLKOUTs. Enabling spread-spectrum clocking for internal clocks, CLKOUTs, and the I<sup>2</sup>S interface may reduce narrow-band emissions by several dB on a particular node. When spread-spectrum clocking is enabled on a clock output, the time interval error (TIE) jitter on that clock increases.

#### *Unique ID*

Each transceiver contains a unique ID, which can be read from registers using software. If a read of the unique ID fails, an interrupt can be generated.

#### *Support for Crossover or Straight Through Cabling*

Straight through cables can be supported by swapping the dc coupling at the B-side connector. See the [Designer Reference](#) section for details about the reference schematics.

***Data Only and Power Only Bus Operation***

The A<sup>2</sup>B bus can be operated without closing the PMOS switch to send a dc bias downstream. Conversely, a dc bias can also be sent downstream without the presence of data. These features are available for debug purposes only.

# AD2420(W)/AD2426(W)/AD2427(W)/AD2428(W)/AD2429(W)

## SPECIFICATIONS

For information about product specifications, contact your Analog Devices, Inc. representative.

### OPERATING CONDITIONS

Parameter	Conditions	Min	Nominal	Max	Unit
<i>Power Supplies</i>					
V <sub>DVDD</sub>	Digital Core Logic Supply Voltage	1.70	1.90	1.98	V
V <sub>IOVDD</sub>	Digital Input/Output (I/O) Supply Voltage	3.3 V I/O	3.3	3.63	V
		1.8 V I/O	1.9	1.98	V
V <sub>PLLVD</sub>	Phased-Locked Loops (PLL) Supply Voltage	1.7	1.9	1.98	V
V <sub>TRXVDD</sub>	Transceiver Supply Voltage	Applies to the ATRXVDD and BTRXVDD pins		3.63	V
V <sub>I2C_VBUS</sub>	External I <sup>2</sup> C Bus Voltage	3.3 V V <sub>IOVDD</sub> , 1.8 V V <sub>IOVDD</sub>	1.9/3.3	3.63	V
<i>Voltage Regulator (VREG1, VREG2)</i>					
V <sub>VIN</sub>	Regulator Input Supply Voltage	Specification must be met at the VIN pin of each A <sup>2</sup> B bus transceiver		9.0	V
V <sub>RST</sub>	V <sub>VIN</sub> Chip Reset Assertion Voltage Threshold	V <sub>VIN</sub> dropping		2.97	V
V <sub>RSTN</sub>	V <sub>VIN</sub> Chip Reset Deassertion Voltage Threshold	V <sub>VIN</sub> rising		3.25	V
<i>Digital I/O</i>					
V <sub>IH</sub> <sup>1</sup>	High Level Input Voltage	V <sub>IOVDD</sub> = 1.98 V		0.7 × V <sub>IOVDD</sub>	V
		V <sub>IOVDD</sub> = 3.63 V		2.2	V
V <sub>IL</sub> <sup>1</sup>	Low Level Input Voltage	V <sub>IOVDD</sub> = 1.70 V		0.3 × V <sub>IOVDD</sub>	V
		V <sub>IOVDD</sub> = 3.00 V		0.8	V
V <sub>IH_I2C</sub> <sup>2</sup>		V <sub>IOVDD</sub> = 3.63 V, 1.98 V		0.7 × V <sub>IOVDD</sub>	V
V <sub>IL_I2C</sub>		V <sub>IOVDD</sub> = 3.00 V, 1.70 V		0.3 × V <sub>IOVDD</sub>	V
<i>Temperature</i>					
T <sub>J</sub>	Junction Temperature <sup>3</sup>	T <sub>AMBIENT</sub> = 0°C to 70°C		105	°C
T <sub>J</sub>	Junction Temperature <sup>4</sup>	T <sub>AMBIENT</sub> = -40°C to +85°C		+105	°C
<b>AUTOMOTIVE USE ONLY</b>					
T <sub>J</sub>	Junction Temperature <sup>5</sup> (Automotive Grade)	T <sub>AMBIENT</sub> = -40°C to +105°C		+125 <sup>6</sup>	°C
T <sub>J</sub>	Junction Temperature <sup>7</sup> (Automotive Grade)	T <sub>AMBIENT</sub> = -40°C to +105°C		+125 <sup>6</sup>	°C

<sup>1</sup> Applies to PDMCLK/IO7, BCLK, SYNC, DTX0/IO3, DTX1/IO4, DRX0/IO5, DRX1/IO6, ADR1/IO1, ADR2/IO2, IRQ/IO0 pins.

<sup>2</sup> Applies to SDA and SCL pins.

<sup>3</sup> Applies to unreleased commercial models (0°C to 70°C) in the [Pending Products](#) table.

<sup>4</sup> Applies to unreleased industrial models (-40°C to +85°C) in the [Pending Products](#) table.

<sup>5</sup> Applies to released models in the [Ordering Guide](#).

<sup>6</sup> Automotive application use profile only. Not supported for nonautomotive use. Contact Analog Devices, Inc., for more information.

<sup>7</sup> Applies to unreleased automotive models (-40°C to +105°C) in the [Pending Products](#) table.



# AD2420(W)/AD2426(W)/AD2427(W)/AD2428(W)/AD2429(W)

## ELECTRICAL CHARACTERISTICS

Parameter	Conditions	Min	Typ	Max	Unit	
<b>Current</b>						
$I_{DVDD}$	Digital Core Logic Supply Current	$V_{DVDD} = 1.98\text{ V}$	9.0	10.5	12.0	mA
$I_{PLLVD}$	PLL Supply Current	$V_{PLLVD} = 1.98\text{ V}$	0.5	1.1	1.5	mA
$I_{TRXVDD}^1$	Transceiver Supply Current	TX enabled, RX disabled, 100% duty cycle ( $I_{TXVDD}$ ), $V_{TRXVDD} = 3.63\text{ V}$	9.5	12.0	13.0	mA
		TX disabled, RX enabled, 100% duty cycle ( $I_{RXVDD}$ ), $V_{TRXVDD} = 3.63\text{ V}$	2.2	2.8	3.5	mA
		TX disabled, RX disabled, 0% activity level, $V_{TRXVDD} = 3.63\text{ V}$	1.0	1.7	2.5	mA
<b>Voltage Regulator (VREG1, VREG2)</b>						
$V_{VOUT1}$	$V_{REG1}$ Output Voltage		1.80	1.90	1.98	V
$V_{VOUT2}$	$V_{REG2}$ Output Voltage		3.15	3.30	3.45	V
$I_{VOUT1}^2$	$V_{REG1}$ Output Current				40.0	mA
$I_{VOUT2}^2$	$V_{REG2}$ Output Current				50.0	mA
$I_{VEXT1}^{3,4}$	$V_{REG1}$ External Device Current	$I_{VOUT1} - I_{PLLVD} - I_{DVDD} - I_{IOVDD}$ current available to external device		20		mA
$I_{VEXT2}^{3,4}$	$V_{REG2}$ External Device Current	$I_{VOUT2} - I_{TRXVDD}$ current available to external device		20		mA
$\Delta V_{OUT1}/\Delta V_{IN}$	Line Regulation	$V_{IN} = 3.7\text{ V to }V_{IN}$	0	0.017	0.055	%/V
$\Delta V_{OUT2}/\Delta V_{IN}$	Line Regulation	$V_{IN} = 3.7\text{ V to }V_{IN}$	0.013	0.030	0.060	%/V
		$V_{IN} = 5.0\text{ V to }8\text{ V}$	-0.025	+0.005	+0.055	%/V
$\Delta V_{OUT1}/\Delta I_{OUT1}$	Load Regulation	$V_{IN} = 5.0\text{ V}$ , $I_{VOUT1} = 1\text{ mA to }40\text{ mA}$		0.009	0.017	%/mA
$\Delta V_{OUT2}/\Delta I_{OUT2}$	Load Regulation	$V_{IN} = 5.0\text{ V}$ , $I_{VOUT2} = 1\text{ mA to }50\text{ mA}$		0.008	0.015	%/mA
$I_{VINQ}$	Quiescent Current	$V_{IN} = V_{IN}$ , $I_{VOUT1} = 0\text{ mA}$ , $I_{VOUT2} = 0\text{ mA}$	530	600	750	$\mu\text{A}$
$I_{VIN}$	Operational Current	$V_{IN} = V_{IN}$ , $I_{VOUT1} = 8\text{ mA}$ , $I_{VOUT2} = 20\text{ mA}$			29	mA
$C_{Load1}$	$V_{REG1}$ Load Capacitance		1.0		25	$\mu\text{F}$
$C_{Load2}$	$V_{REG2}$ Load Capacitance		2.2		25	$\mu\text{F}$
<b>Digital I/O</b>						
$I_{IH}$	Input Leakage, High	$V_{IOVDD} = 3.63\text{ V}$ , $V_{IN} = 3.63\text{ V}$			10.0	$\mu\text{A}$
$I_{IL}$	Input Leakage, Low	$V_{IOVDD} = 3.63\text{ V}$ , $V_{IN} = 0\text{ V}$			10.0	$\mu\text{A}$
$I_{OZH\_I2C}^5$	Three-State Leakage Current	$V_{IOVDD} = 1.9\text{ V}$ , $V_{IN} = 3.63\text{ V}$			10.0	$\mu\text{A}$
$V_{OH1,9}$	High Level Output Voltage	$V_{IOVDD} = 1.70\text{ V}$ , $I_{OH} = 1\text{ mA}$	1.35			V
$V_{OH3,3}$	High Level Output Voltage	$V_{IOVDD} = 3.00\text{ V}$ , $I_{OH} = 1\text{ mA}$	2.40			V
$V_{OL}^6$	Low Level Output Voltage	$V_{IOVDD} = 3.00\text{ V}$ , $I_{OL} = 1\text{ mA}$			0.40	V
$V_{OL}^6$	Low Level Output Voltage	$V_{IOVDD} = 1.70\text{ V}$ , $I_{OL} = 1\text{ mA}$			0.40	V
$V_{OL\_I2C}^{5,7}$	I <sup>2</sup> C Low Level Output Voltage	$V_{IOVDD} = 3.00\text{ V}$ , $I_{OL} = 1.5\text{ mA}$			0.40	V
$V_{OL\_I2C}^{5,7}$	I <sup>2</sup> C Low Level Output Voltage	$V_{IOVDD} = 1.70\text{ V}$ , $I_{OL} = 1.5\text{ mA}$			0.40	V
$C_{PD}$	Pin Capacitance			4.8	5	pF
<b>Negative Bias Switch</b>						
$I_{VSSN}$	Internal $V_{SSN}$ Switch Current	AD2426(W)/AD2427(W)/AD2428(W)			300	mA
$I_{VSSN}$	Internal $V_{SSN}$ Switch Current	AD2420(W)/AD2429(W)			100	mA
$R_{VSSN}$	Internal $V_{SSN}$ On Resistance				1.2	$\Omega$

<sup>1</sup> Master and last slave only consume half the transceiver current because only one of the two TRX blocks is used.

<sup>2</sup> In a bus powered system,  $I_{VOUT}$  has a direct impact on  $I_{VSSN}$  and  $V_{IN}$  in other nodes. For more information, see the [Power Analysis](#) section.

<sup>3</sup> Consider the package thermal limits when dissipating current above typical limits. For more information, see the [Thermal Characteristics](#) section.

<sup>4</sup> Must comply with  $I_{VOUT1}$  and  $I_{VOUT2}$  maximum.

<sup>5</sup> Applies to SDA and SCL pins.

<sup>6</sup> Applies to BCLK, SYNC, DTX0/IO3, DTX1/IO4, DRX0/IO5, DRX1/IO6, ADR1/IO1, ADR2/IO2, IRQ/IO0, PDMCLK/IO7 pins.

<sup>7</sup> The minimum  $I_{OL}$  current is lower than the I<sup>2</sup>C specification because the SDA and SCL pins are designed for a limited number of I<sup>2</sup>C attached slave devices.

# AD2420(W)/AD2426(W)/AD2427(W)/AD2428(W)/AD2429(W)

**Table 2. Differential Input/Output**

Parameter	Conditions	Min	Typ	Max	Unit
<i>LVDS</i>					
$ V_{OD} $	Differential Output Voltage Magnitude				
	High Transmit Level	425		545	mV
	Medium Transmit Level	315		415	mV
	Low Transmit Level	210		305	mV
<i>Receiver</i>					
$V_{TH}$	Differential Input Threshold Voltage	-52		+52	mV

## POWER SUPPLY REJECTION RATIO (PSRR)

Typical PSRR at  $T_j = 40^\circ\text{C}$  with load capacitance  
 $C_{\text{LOAD}} = 4.7\ \mu\text{F} \parallel 100\ \mu\text{F}$ .

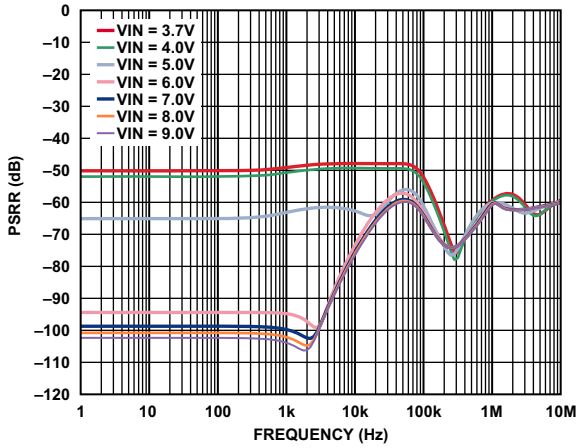

Figure 5. VOUT1 PSRR,  $I_{\text{OUT1}} = 10\ \text{mA}$

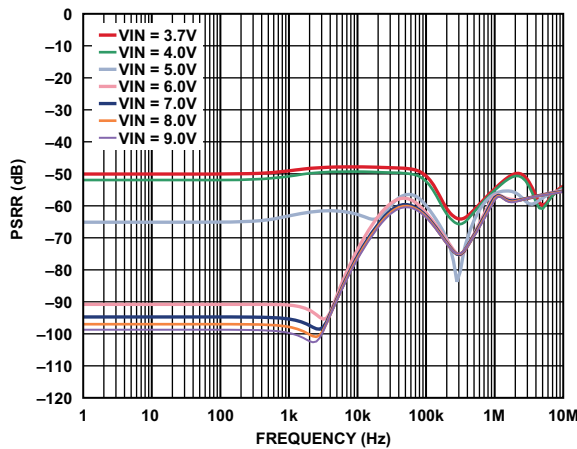

Figure 6. VOUT1 PSRR,  $I_{\text{OUT1}} = 40\ \text{mA}$

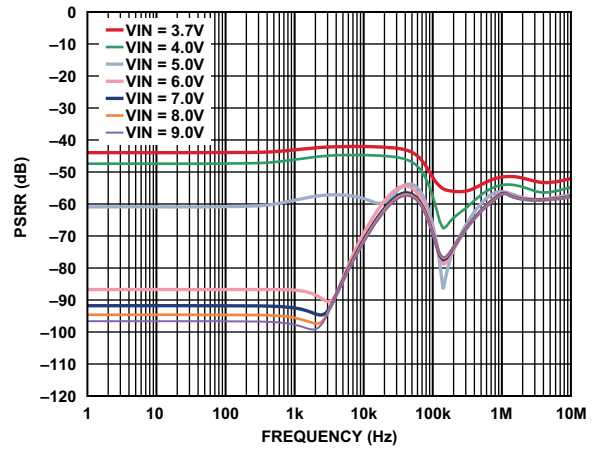

Figure 7. VOUT2 PSRR,  $I_{\text{OUT2}} = 10\ \text{mA}$

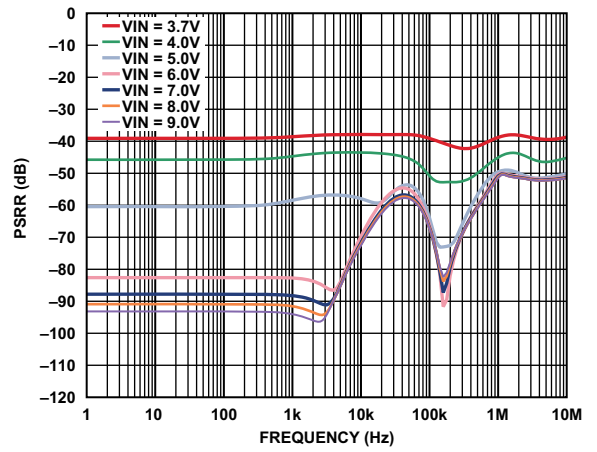

Figure 8. VOUT2 PSRR,  $I_{\text{OUT2}} = 50\ \text{mA}$

# AD2420(W)/AD2426(W)/AD2427(W)/AD2428(W)/AD2429(W)

## TIMING SPECIFICATIONS

**Table 3. Clock and Reset Timing (A<sup>2</sup>B Master)**

Parameter	Min	Typ	Max	Unit
<i>Timing Requirements</i>				
f <sub>SYNCM</sub>	43.6	44.1, 48.0	48.5	kHz
t <sub>SYNCJ</sub>		0.29	1.0	ns
t <sub>SYNCOJ</sub>			2.6	ns
f <sub>SYSBCLK</sub>		1024 × f <sub>SYNCM</sub>		kHz
t <sub>DNSYNCR</sub> <sup>1</sup>	0.64		0.74	ms
t <sub>DNSCFR</sub> <sup>1</sup>	0.64		0.74	ms
t <sub>PLK</sub>		7.5		ms

<sup>1</sup> Only consecutive missed SYNC or SCF transitions for the specified duration result in a reset.

**Table 4. Pulse Density Modulation Microphone Input Timing**

Parameter	Min	Typ	Max	Unit
<i>Timing Requirements</i>				
t <sub>RISS</sub>	12.0			ns
t <sub>RIHS</sub>	0			ns
t <sub>RISS</sub>	12.5			ns
t <sub>RIHS</sub>	0			ns
<i>Switching Characteristics</i>				
f <sub>BCLK</sub>	3.05		3.18	MHz
t <sub>BCLKOJ</sub>			175	ps
t <sub>SOL</sub>	161.0			ns

**Table 5. GPIO Timing**

Parameter	Min	Typ	Max	Unit
<i>Timing Requirement</i>				
t <sub>FIPW</sub>				ns
<i>Switching Characteristic</i>				
t <sub>FOPW</sub>				ns

# AD2420(W)/AD2426(W)/AD2427(W)/AD2428(W)/AD2429(W)

**Table 6. I<sup>2</sup>C Port Timing**

Parameter	Min	Typ	Max	Unit
<i>Timing Requirements</i>				
f <sub>SCL</sub> SCL Clock Frequency	0		400	kHz
t <sub>SCLH</sub> SCL Pulse Width High	0.6			μs
t <sub>SCLL</sub> SCL Pulse Width Low	1.3			μs
t <sub>SCS</sub> Start and Repeated Start Condition Setup Time	0.6			μs
t <sub>SCH</sub> Start Condition Hold Time	0.6			μs
t <sub>SPS</sub> Stop Condition Hold Time	0.6			μs
t <sub>DS</sub> Data Setup Time	100			ns
t <sub>DH</sub> Data Hold Time	0.0		0.9	μs
t <sub>SCLR</sub> SCL Rise Time			300	ns
t <sub>SCLF</sub> SCL Fall Time			300	ns
t <sub>SDR</sub> SDA Rise Time			300	ns
t <sub>SDF</sub> SDA Fall Time			300	ns
t <sub>BFT</sub> Bus-Free Time Between Stop and Start	1.3			μs

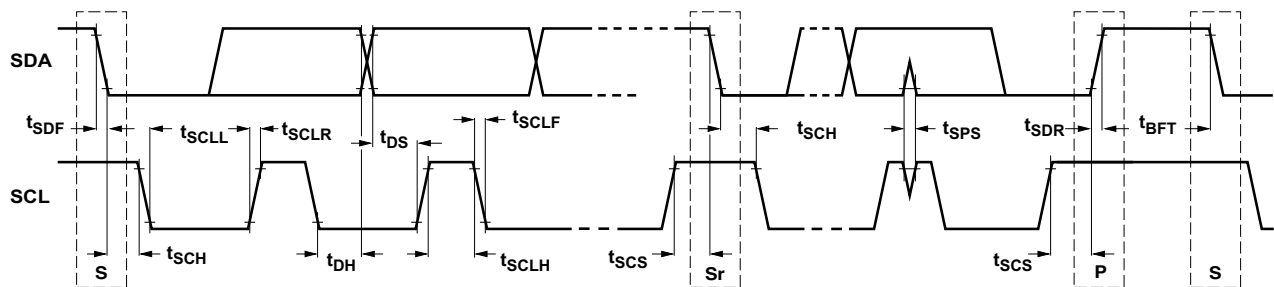

Figure 9. I<sup>2</sup>C Port Timing

# AD2420(W)/AD2426(W)/AD2427(W)/AD2428(W)/AD2429(W)

**Table 7. I<sup>2</sup>S Timing**

Parameter	1.8 V		3.3 V		Unit
	Min	Max	Min	Max	
<i>I<sup>2</sup>S Slave Timing Requirements (A<sup>2</sup>B Master)</i>					
t <sub>BCLKW</sub>	BCLK Width		19.5	9.5	ns
t <sub>BCLKS</sub>	BCLK Period		39.0	19.0	ns
t <sub>SIS</sub> <sup>1</sup>	SYNC Input Setup Before BCLK Sample Edge		2.25	2.25	ns
t <sub>SIH</sub> <sup>1</sup>	SYNC Input Hold After BCLK Sample Edge		2.0	3.0	ns
t <sub>RISM</sub> <sup>1</sup>	DRXn Input Setup Before BCLK Sample Edge		0.5	0.5	ns
t <sub>RIHM</sub> <sup>1</sup>	DRXn Input Hold After BCLK Sample Edge		2.0	1.5	ns
t <sub>RISM</sub> <sup>1</sup>	DRX1 on DTX1 Input Setup Before BCLK Sample Edge		4.0	4.5	ns
t <sub>RIHM</sub> <sup>1</sup>	DRX1 on DTX1 Input Hold After BCLK Sample Edge		0.5	0.5	ns
<i>I<sup>2</sup>S Slave Switching Characteristics (A<sup>2</sup>B Master)</i>					
t <sub>DODM</sub> <sup>2</sup>	DTXn Output Delay After BCLK Drive Edge			15.25	ns
t <sub>DOHM</sub> <sup>2</sup>	DTXn Output Hold After BCLK Drive Edge		3.0		ns
t <sub>DOENM</sub> <sup>2</sup>	DTXn Data Enable Delay After BCLK Drive Edge		2.0		ns
t <sub>DODIM</sub> <sup>2</sup>	DTXn Data Disable Delay After BCLK Drive Edge			13.0	ns
<i>I<sup>2</sup>S Master Timing Requirements (A<sup>2</sup>B Slave)</i>					
t <sub>RISS</sub> <sup>1</sup>	DRXn Input Setup Before BCLK Sample Edge		0.0	0.0	ns
t <sub>RIHS</sub> <sup>1</sup>	DRXn Input Hold After BCLK Sample Edge		5.8	2.0	ns
t <sub>RISS</sub> <sup>1</sup>	DRX1 on DTX1 Input Setup Before BCLK Sample Edge		2.5	4.5	ns
t <sub>RIHS</sub> <sup>1</sup>	DRX1 on DTX1 Input Hold After BCLK Sample Edge		2.5	0.5	ns
<i>I<sup>2</sup>S Master Switching Characteristics (A<sup>2</sup>B Slave)</i>					
f <sub>BCLK</sub>	BCLK Output Frequency <sup>3</sup>			25.0	MHz
t <sub>BCLKMOJ</sub>	BCLK Output Jitter (RMS Cycle to Cycle, f <sub>BCLKS</sub> = 12.288 MHz)			100	ps
t <sub>SOL</sub> /t <sub>SOH</sub>	Transmit or Receive BCLK Duty Cycle		0.45	0.55	t <sub>BCLK</sub>
t <sub>SOJ</sub>	SYNC Output Jitter (RMS Cycle to Cycle f <sub>SYNCM</sub> = 48 kHz)			2.2	ns
t <sub>SOD</sub> <sup>2</sup>	SYNC Output Delay After BCLK Drive Edge			6.5	ns
t <sub>SOHD</sub> <sup>2</sup>	SYNC Output Hold After BCLK Drive Edge		2.8	4.5	ns
t <sub>DODS</sub> <sup>2</sup>	DTXn Output Delay After BCLK Drive Edge			10.8	ns
t <sub>DOHS</sub> <sup>2</sup>	DTXn Output Hold After BCLK Drive Edge		5.5	6.0	ns

<sup>1</sup> Referenced to sample edge.

<sup>2</sup> Referenced to drive edge.

<sup>3</sup> When V<sub>I<sub>OVDD</sub></sub> = 3.3 V, the setup and hold timing at the 50 MHz maximum bit clock rate can be violated when interfacing with other I<sup>2</sup>S devices. The timing violations are seen when the A<sup>2</sup>B slave node is receiving and A<sup>2</sup>B master node is transmitting. In these modes, the maximum BCLK frequency of 50 MHz cannot be achieved.

# AD2420(W)/AD2426(W)/AD2427(W)/AD2428(W)/AD2429(W)

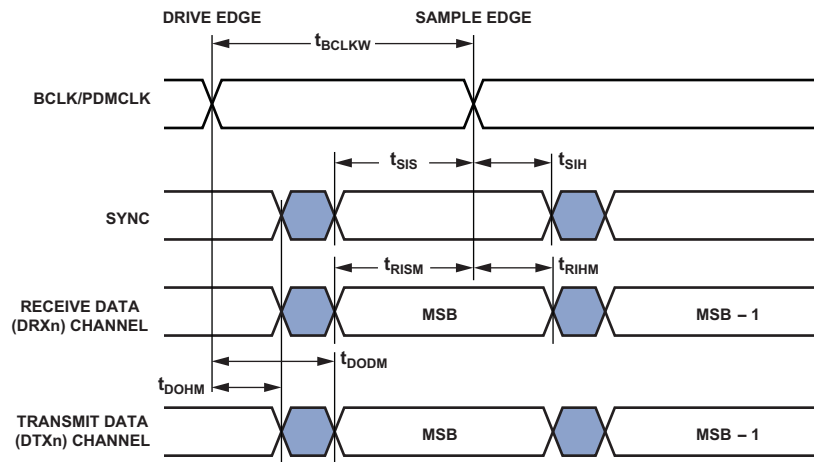

Figure 10. I<sup>2</sup>S Slave (A<sup>2</sup>B Master) Timing

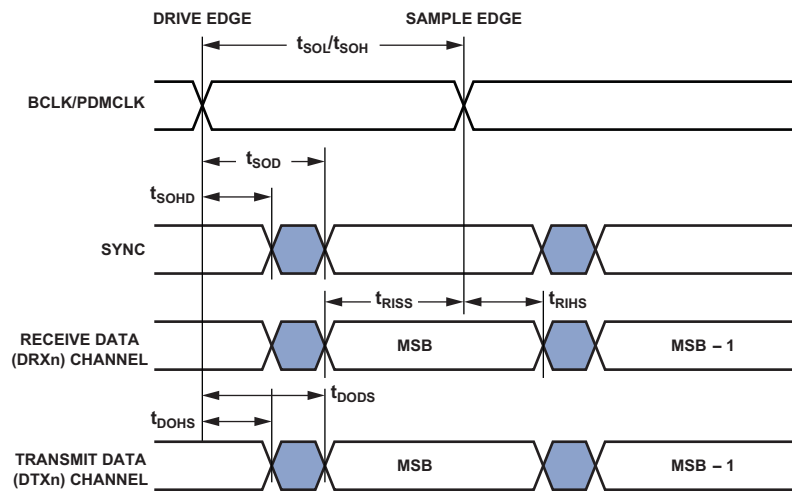

Figure 11. I<sup>2</sup>S Master (A<sup>2</sup>B Slave) Timing

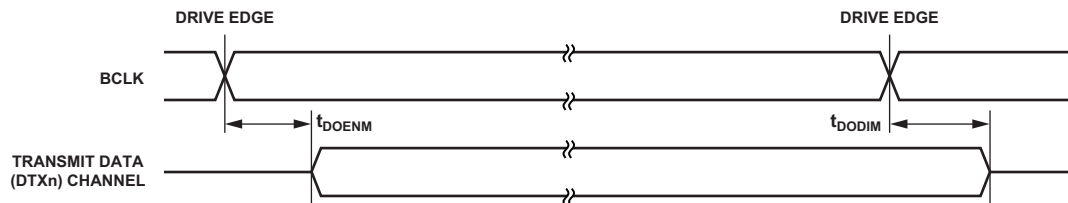

Figure 12. I<sup>2</sup>S Slave (A<sup>2</sup>B Master) Enable and Three-State Timing

# AD2420(W)/AD2426(W)/AD2427(W)/AD2428(W)/AD2429(W)

## POWER-UP SEQUENCING RESTRICTIONS

When externally supplied,  $V_{DVDD}$  and  $V_{IOVDD}$  must reach at least 90% of specification before  $V_{VIN}$  begins ramping. To avoid damage to input pins and to ensure correct sampling of the ADR1/ADR2 pins at start-up,  $V_{IOVDD}$  must be within specification before input signals are driven by external devices.

**Table 8. Power-Up Timing**

Parameter	Min	Max	Unit	
<i>Timing Requirements</i>				
$t_{VIN}$	When Externally Supplied, $V_{DVDD}$ and $V_{IOVDD}$ Must Reach 90% of Specification Before $V_{VIN}$ Begins Ramping		>0	ms
$t_{PORST}$	Minimum Time Required for $V_{VIN}$ to be Held Below $V_{RST}$ to Assert Power on Reset		25	ms

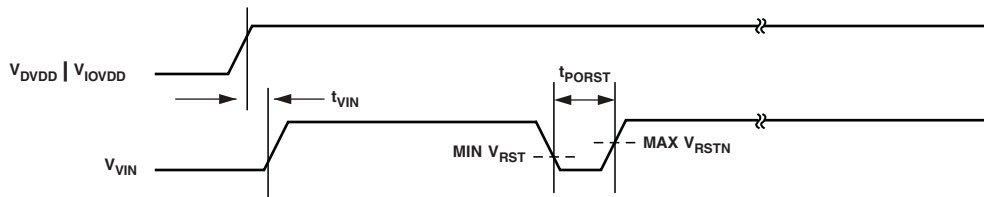

Figure 13. Power-Up Sequencing Timing with Externally Supplied  $V_{DVDD}$  and  $V_{IOVDD}$



# AD2420(W)/AD2426(W)/AD2427(W)/AD2428(W)/AD2429(W)

## A<sup>2</sup>B BUS SYSTEM SPECIFICATION

**Table 9. A<sup>2</sup>B System Specifications**

Parameter	System Specification
Cable	Unshielded, single, twisted pair wire (UTP) with 100 Ω differential impedance. EMC performance and full functionality under worst-case environmental conditions is confirmed with Leoni Dacar 545 cable (76D00305).
Maximum Cable Length	
AD2428(W) Mastered System	40 m total, 15 m between nodes.
AD2429(W) Mastered System	10 m total, 5 m between nodes.
Maximum Number of Nodes	
AD2428(W) Mastered System	11 nodes (1 master node and 10 slave nodes).
AD2429(W) Mastered System	Three nodes (1 master node and 2 slave nodes).
Maximum Number of Audio Slots	
AD2426(W)/AD2427(W)/AD2428(W) <sup>1</sup>	64 total, up to 32 upstream and 32 downstream slots, depending upon system design.
AD2420(W)/AD2429(W) <sup>1</sup>	AD2429(W): 4 upstream and 2 downstream slots, depending upon system design. AD2420(W): 2 upstream slots, depending upon system design.
Number of Audio Channels per Slave Node	Individually programmable 0 to 32 upstream channels and 0 to 32 downstream channels.
Synchronous A <sup>2</sup> B Data Slot Size	8, 12, 16, 20, 24, 28, or 32 bits to match I <sup>2</sup> S/TDM data-word lengths. Same slot size for all nodes. Upstream and downstream can choose different slot sizes. 12-, 16-, or 20-bit slot sizes can carry compressed data over the A <sup>2</sup> B bus for 16-, 20-, or 24-bit I <sup>2</sup> S/TDM word lengths.
Audio Sampling Frequency	44.1 kHz to 48 kHz. All nodes sample synchronously. Slave node transceivers support sample rates ( $f_s$ ) of 1× (48 kHz), 2× (96 kHz) or 4× (192 kHz), individually configured per slave. To support 2× and 4× sampling rates in slaves, the master uses two and four times the number of I <sup>2</sup> S/TDM data channels as the 1× sampling frequency ( $f_{\text{SYNCM}}$ ) interface to the host. Transceivers also support reduced rate sampling for 24 kHz, 12 kHz, 6 kHz, 4 kHz, 3 kHz, 2.4 kHz, 2 kHz, 1.71 kHz, or 1.5 kHz at a low latency 48 kHz superframe rate.
Discovery Time	Less than 35 ms per node. Much less than 350 ms for total system startup in a system with 10 nodes. Includes register initialization.
Bit Error Detection	Robust error detection for control data and status data with 16-bit cyclic redundancy check (CRC).
Error Correction	Parity and line code error detection on synchronous data slots with audio error correction (repeat of last known good data). For 24-bit and 32-bit data channels, single error correction and double error detection (SECDED) of synchronous data slots is possible.
Failure Diagnostics <sup>1</sup>	Location and cause of failure can be detected for A <sup>2</sup> B wires shorted to a high voltage (for example, positive terminal of car battery), shorted to ground, wires shorted to each other, wires reversed or open connection.
System EMI/EMC	Meets or exceeds industry specifications for robustness (ISO 11452-2, ISO 11452-4, ISO 7637-3) and emissions (CISPR25).
System ESD	See IEC ESD ratings in <a href="#">Table 12</a> for terminals.

<sup>1</sup> See the *AD2420(W)/6(W)/7(W)/8(W)/9(W) Automotive Audio Bus A<sup>2</sup>B Transceiver Technical Reference* for more information.

# AD2420(W)/AD2426(W)/AD2427(W)/AD2428(W)/AD2429(W)

## RMS Time Interval Error (TIE) Jitter

Clocks in an A<sup>2</sup>B system are passed from the master to Slave 0, from Slave 0 to Slave 1, and so on. Each transceiver adds self jitter to the incoming jitter, which results in jitter growth from the master to the n<sup>th</sup> slave. Table 10 illustrates typical rms TIE jitter growth.

Table 10. SYNC Output RMS TIE Jitter at Each Slave

Slave Node	Typ	Max	Unit
1	1.57		ns
2	1.79		ns
3	1.91		ns
4	2.04		ns
5	2.15		ns
6	2.27		ns
7	2.44		ns
8	2.47		ns
9	2.58		ns
10	2.70	5.50	ns

## PDM TYPICAL PERFORMANCE CHARACTERISTICS

Figure 14 through Figure 18 and Table 11 describe typical PDM performance characteristics.

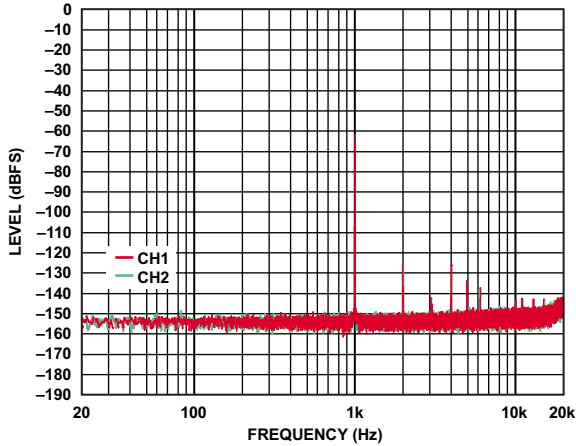

Figure 14. PDM FFT,  $f_{\text{SYNC}} = 48 \text{ kHz}$ ,  $-60 \text{ dB}$  Frame Sync Input

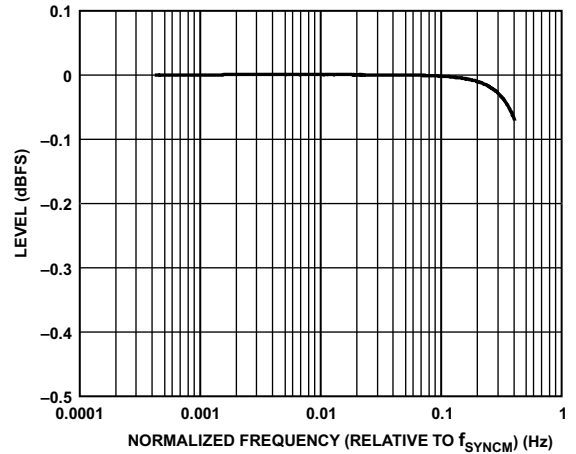

Figure 15. PDM Frequency Response

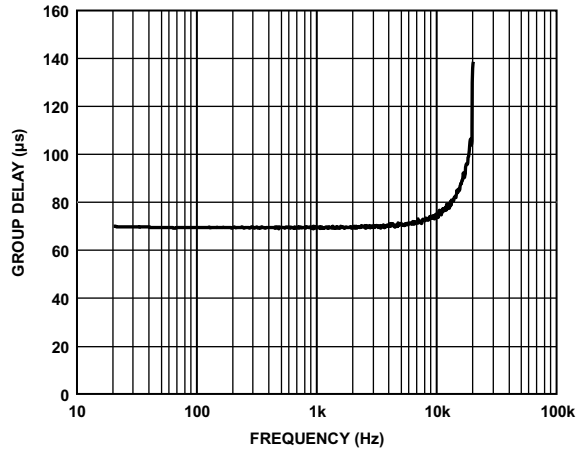

Figure 16. PDM Group Delay vs. Frequency,  $f_{\text{SYNCM}} = 48 \text{ kHz}$

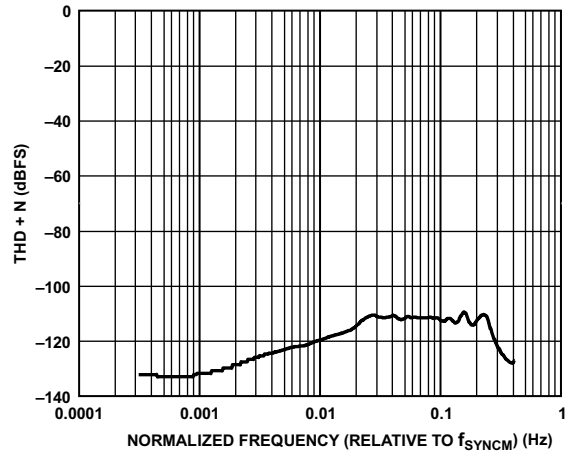

Figure 17. PDM Total Harmonic Distortion + Noise (THD + N) vs. Normalized Frequency (Relative to  $f_{\text{SYNCM}}$ )

# AD2420(W)/AD2426(W)/AD2427(W)/AD2428(W)/AD2429(W)

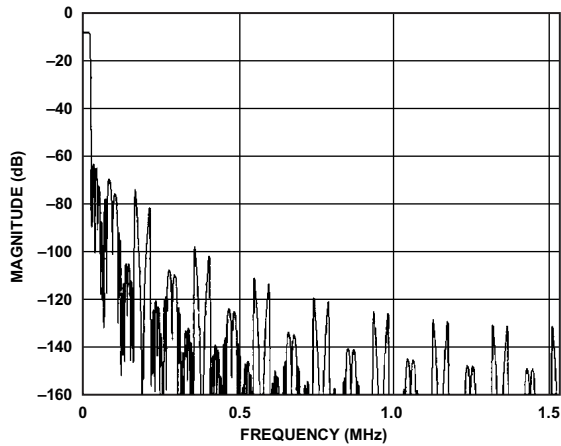

Figure 18. PDM Out of Band Frequency Response (48 kHz Output)

**Table 11. PDM Interface Performance Specifications**

Parameter	Conditions	Min	Typ	Max	Unit
Dynamic Range With A-Weighted Filter (RMS)	20 Hz to 20 kHz, -60 dB input		120		dB
SNR	A-weighted, fourth-order input		120		dB
Decimation Ratio	Default is 64×	64×	128×	256×	
Frequency Response	DC to 0.45 $f_{\text{SYNCM}}$	-0.1		+0.01	dB
Stop Band Attenuation		74	0.566		$f_{\text{SYNCM}}$ dB
Group Delay	0.02 $f_{\text{SYNCM}}$ input signal		3.80		$f_{\text{SYNCM}}$ cycles
Gain	PDM to PCM		0		dB
Start-Up Time <sup>1</sup>			48		$f_{\text{SYNCM}}$ cycles
Bit Width	Internal and output		24		Bits

<sup>1</sup> The PDM start-up time is the time for the filters to settle after the PDM block is enabled. It is the time to wait before data is guaranteed to meet the specified performance.

# AD2420(W)/AD2426(W)/AD2427(W)/AD2428(W)/AD2429(W)

## ABSOLUTE MAXIMUM RATINGS

Stresses at or above those listed in Table 12 can cause permanent damage to the product. This is a stress rating only; functional operation of the product at these or any other conditions above those indicated in the operational section of this specification is not implied. Operation beyond the maximum operating conditions for extended periods may affect product reliability.

Table 12. Absolute Maximum Ratings

Parameter	Rating
VIN to VSS	-0.7 V to +30 V
Power Supply IOVDD to VSS	-0.3 V to +3.63 V
Power Supply DVDD to VSS	-0.3 V to +1.98 V
Power Supply PLLVDD to VSS	-0.3 V to +1.98 V
Power Supply TRXVDD to VSS	-0.3 V to +3.63 V
Digital Pin Output Voltage Swing <sup>1</sup>	-0.3 V to V <sub>IOVDD</sub> + 0.5 V
Input Voltage <sup>2,3</sup>	-0.33 V to +3.63 V
Input Voltage <sup>2,4</sup>	-0.33 V to +2.10 V
I <sup>2</sup> C Input Voltage <sup>2,5</sup>	-0.33 V to +5.5 V
A <sup>2</sup> B Bus Terminal Voltage	
AP, AN, BP, and BN Pins	-0.5 V to +4.1 V
SENSE, SWP, VSSN Voltage to V <sub>SS</sub>	+30 V maximum
Storage Temperature Range	-65°C to +150°C
Junction Temperature While Biased	-40°C to +125°C
ESD Rating HBM	
VIN and SWP Pins	±2.5 kV
AP, AN, BP, and BN Pins	±2.5 kV
All Other Pins	±2.5 kV
ESD Rating FICDM	
All Pins	±1.25 kV
System ESD Rating CON1-A and CON1-B Terminals <sup>6</sup>	
IEC 61000-4-2, Air Discharge	±15 kV
IEC 61000-4-2, Contact Discharge	±12 kV
Digital Pin Output Current per Pin Group <sup>7</sup>	15 mA

<sup>1</sup> Applies to BCLK, SYNC, DTX0/IO3, DTX1/DRX1/IO4, DRX0/IO5, DRX1/IO6, IRQ/IO0, ADR1/IO1, ADR2/IO2, PDMCLK/IO7.

<sup>2</sup> Only applies when the related power supply (V<sub>IOVDD</sub>) is within specification. When the power supply is below specification, the range is the voltage being applied to that power domain ± 0.2 V.

<sup>3</sup> Applies when nominal V<sub>IOVDD</sub> is 3.3 V.

<sup>4</sup> Applies when nominal V<sub>IOVDD</sub> is 1.8 V.

<sup>5</sup> Applies to SCL and SDA.

<sup>6</sup> CON1-A and CON1-B are connectors.

<sup>7</sup> For more information, see the following description and Table 13.

Permanent damage can occur if the digital pin output current per pin group value is exceeded. For example, if three pins from Group 2 in Table 13 are sourcing or sinking 2 mA each, the total current for those pins is 6 mA. Up to 9 mA can be sourced or sunk by the remaining pins in the group without damaging the device.

Table 13. Total Current Pin Groups

Group	Pins in Group
1	IRQ/IO0, ADR1/IO1, ADR2/IO2
2	BCLK, SYNC, DTX0/IO3, DTX1/DRX1/IO4, DRX0/IO5, DRX1/IO6, IO7

## THERMAL CHARACTERISTICS

To determine the junction temperature on the application printed circuit board (PCB), use the following equations:

$$T_J = T_{CASE} + \Psi_{JT} \times P_D$$

where:

$T_J$  = junction temperature (°C).

$T_{CASE}$  = case temperature (°C) measured by customer at top center of package.

$\Psi_{JT}$  = values in Table 14.

$P_D$  = power dissipation.

Values of  $\theta_{JA}$  are provided for package comparison and PCB design considerations. Use  $\theta_{JA}$  for a first-order approximation of  $T_J$  by the following equation:

$$T_J = T_A + \theta_{JA} \times P_D$$

where  $T_A$  = ambient temperature (°C).

Values of  $\theta_{JC}$  are provided for package comparison and PCB design considerations when an external heat sink is required.

Values of  $\theta_{JB}$  are provided for package comparison and PCB design considerations.

Thermal characteristics of the LFCSP\_SS package are shown in Table 14. See JESD51-13 for detailed parameter definitions.

The junction to board measurement complies with JESD51-8.

The junction to case measurement complies with MIL-STD-883 (Method 1012.1). All measurements use a 2S2P JEDEC test board.

Table 14. Thermal Characteristics

Parameter	Conditions	Typical (°C/W)
$\theta_{JA}$	Airflow = 0 m/s	31.6
$\theta_{JMA}$	Airflow = 1 m/s	28.8
$\theta_{JMA}$	Airflow = 2 m/s	28.1
$\theta_{JC}$	Airflow = 0 m/s	4.6
$\theta_{JB}$	Airflow = 0 m/s	14.7
$\Psi_{JT}$	Airflow = 0 m/s	0.20
$\Psi_{JT}$	Airflow = 1 m/s	0.27
$\Psi_{JT}$	Airflow = 2 m/s	0.30

# AD2420(W)/AD2426(W)/AD2427(W)/AD2428(W)/AD2429(W)

The 32-lead LFCSP\_SS package requires thermal trace squares and thermal vias to an embedded ground plane in the PCB. The exposed paddle must connect to ground for proper operation to data sheet specifications. Refer to JEDEC standard JESD51-5 for more information.

## ESD CAUTION



**ESD (electrostatic discharge) sensitive device.** Charged devices and circuit boards can discharge without detection. Although this product features patented or proprietary protection circuitry, damage may occur on devices subjected to high energy ESD. Therefore, proper ESD precautions should be taken to avoid performance degradation or loss of functionality.

## TEST CIRCUITS AND SWITCHING CHARACTERISTICS

Figure 19 shows a line driver voltage measurement circuit of the differential line driver and receiver AP/AN and BP/BN pins.

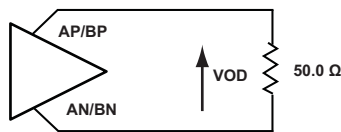

Figure 19. Differential Line Driver Voltage Measurement

## OUTPUT DRIVE CURRENTS

Figure 20 through Figure 25 show typical current voltage characteristics for the output drivers of the transceiver. The curves represent the current drive capability of the output drivers as a function of output voltage. Drive Strength 0 is DS0, and Drive Strength 1 is DS1.

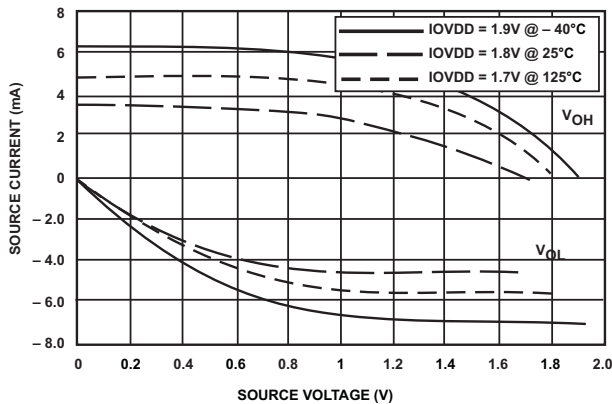

Figure 20. GPIO, BCLK, and SYNC Drivers (DS0, 1.8 V IOVDD)

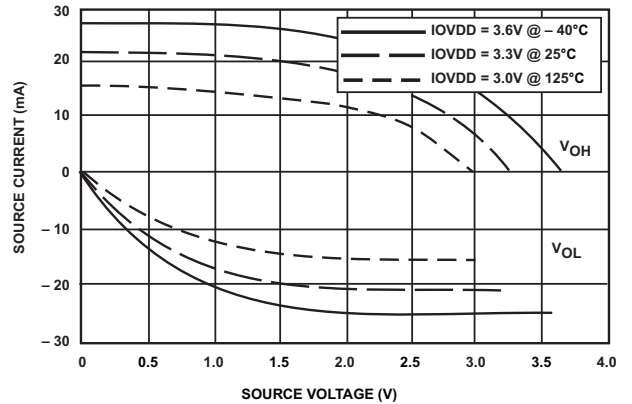

Figure 21. GPIO, BCLK, and SYNC Drivers (DS0, 3.3 V IOVDD)

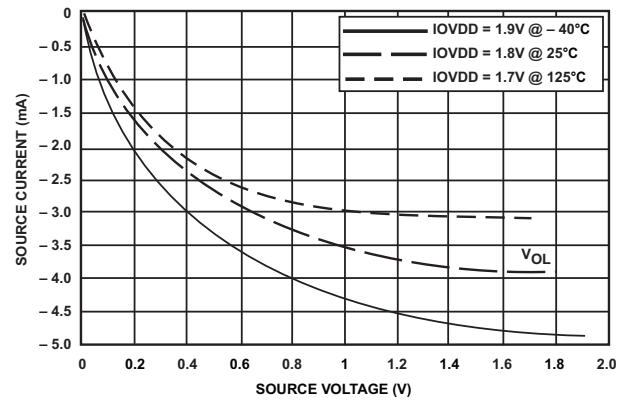

Figure 22. P\_C Drivers (1.8 V IOVDD)

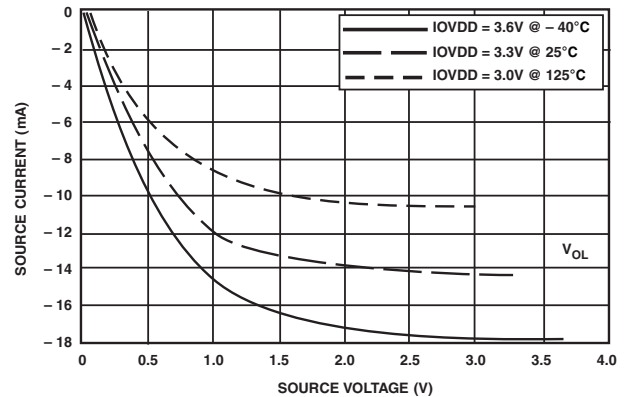

Figure 23. P\_C Drivers (3.3 V IOVDD)

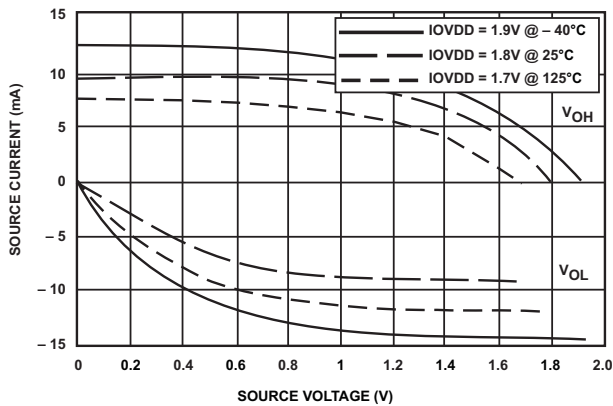

Figure 24. GPIO, BCLK, and SYNC Drivers (DS1, 1.8 V IOVDD)

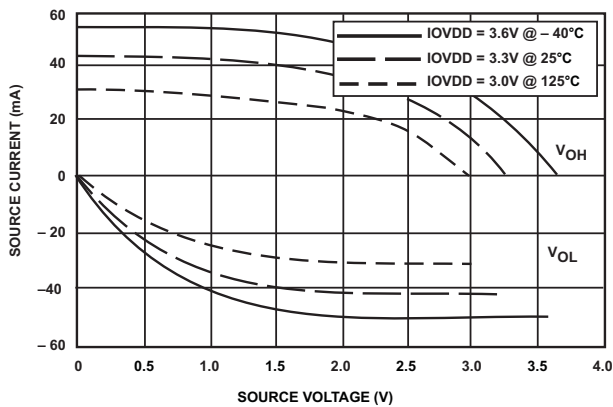

Figure 25. GPIO, BCLK, and SYNC Drivers (DS1, 3.3 V IOVDD)

## TEST CONDITIONS

All timing parameters in this data sheet were measured under the conditions described in this section. Figure 26 shows the measurement point for ac measurements (except output enable/disable). The measurement point,  $V_{MEAS}$ , is  $V_{IOVDD}/2$  for  $V_{IOVDD}$  (nominal) = 3.3 V.



Figure 26. Voltage Reference Levels for AC Measurements (Except Output Enable/Disable)

## Output Enable Time Measurement

Output pins are considered enabled when they make a transition from a high impedance state to the point when they start driving.

The output enable time,  $t_{ENA}$ , is the interval from the point when a reference signal reaches a high or low voltage level to the point when the output starts driving, as shown on the right side of Figure 27. If multiple pins are enabled, the measurement value is that of the first pin to start driving.

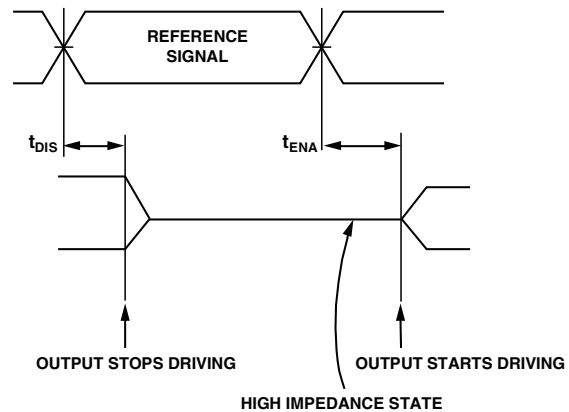

Figure 27. Output Enable/Disable

## Output Disable Time Measurement

Output pins are considered disabled when they stop driving, enter a high impedance state, and start to decay from the output high or low voltage. The output disable time,  $t_{DIS}$ , is the interval from when a reference signal reaches a high or low voltage level to the point when the output stops driving, as shown on the left side of Figure 27.

## Capacitive Loading

Output delays and holds are based on standard capacitive loads of an average of 6 pF on all pins (see Figure 28).  $V_{LOAD}$  is equal to  $V_{IOVDD}/2$ . Figure 29 through Figure 32 show how output rise time varies with capacitance. The delay and hold specifications given must be derated by a factor derived from these figures. The graphs in Figure 29 through Figure 32 cannot be linear outside the ranges shown.

### TESTER PIN ELECTRONICS

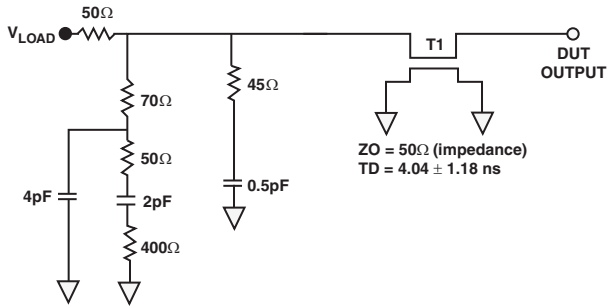

**NOTES:**  
 THE WORST CASE TRANSMISSION LINE DELAY IS SHOWN AND CAN BE USED FOR THE OUTPUT TIMING ANALYSIS TO REFLECT THE TRANSMISSION LINE EFFECT AND MUST BE CONSIDERED. THE TRANSMISSION LINE (TD) IS FOR LOAD ONLY AND DOES NOT AFFECT THE DATA SHEET TIMING SPECIFICATIONS.

ANALOG DEVICES RECOMMENDS USING THE IBIS MODEL TIMING FOR A GIVEN SYSTEM REQUIREMENT. IF NECESSARY, THE SYSTEM CAN INCORPORATE EXTERNAL DRIVERS TO COMPENSATE FOR ANY TIMING DIFFERENCES.

Figure 28. Equivalent Device Loading for AC Measurements (Includes All Fixtures)

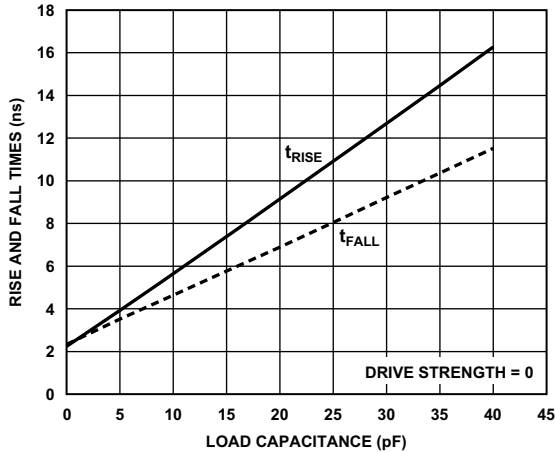

Figure 29. GPIO Driver Typical Rise and Fall Times (10% to 90%) vs. Load Capacitance ( $V_{IOVDD} = 1.8\text{ V}$ ,  $T_J = 25^\circ\text{C}$ )

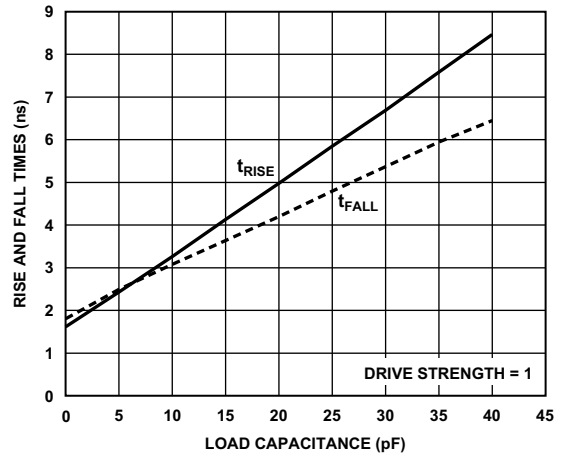

Figure 30. GPIO Driver Typical Rise and Fall Times (10% to 90%) vs. Load Capacitance ( $V_{IOVDD} = 1.8\text{ V}$ ,  $T_J = 25^\circ\text{C}$ )

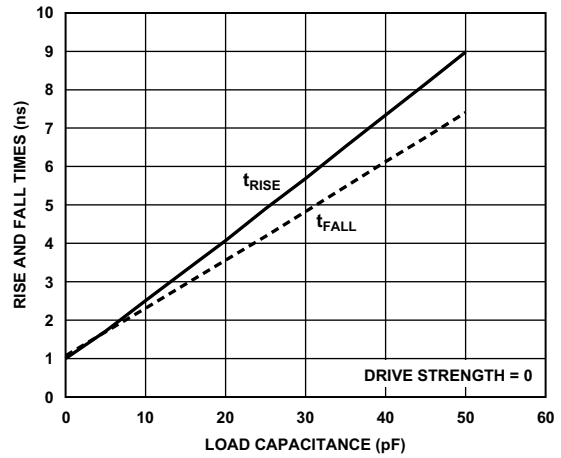

Figure 31. GPIO Driver Typical Rise and Fall Times (10% to 90%) vs. Load Capacitance ( $V_{IOVDD} = 3.3\text{ V}$ ,  $T_J = 25^\circ\text{C}$ )

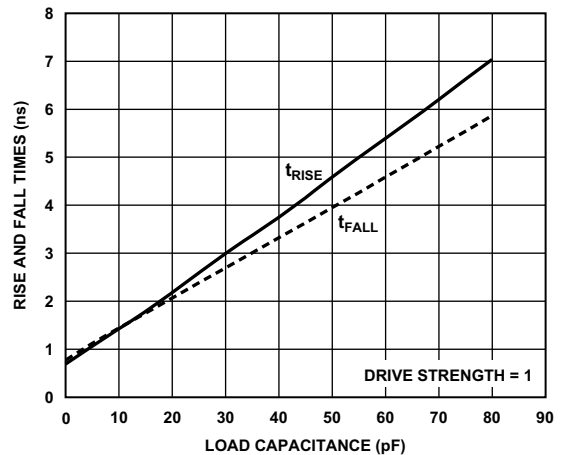

Figure 32. GPIO Driver Typical Rise and Fall Times (10% to 90%) vs. Load Capacitance ( $V_{IOVDD} = 3.3\text{ V}$ ,  $T_J = 25^\circ\text{C}$ )

# AD2420(W)/AD2426(W)/AD2427(W)/AD2428(W)/AD2429(W)

## PIN CONFIGURATION AND FUNCTION DESCRIPTIONS

The 32-lead LFCSP\_SS package pin configuration is shown in Figure 33. The pin function descriptions are shown in Table 15.

All digital inputs and digital outputs are three-stated with inputs disabled during reset.

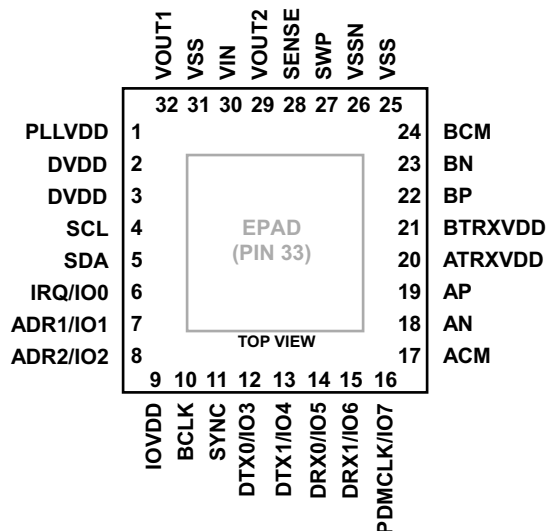

PIN 33 IS THE EXPOSED PAD ON THE BOTTOM OF THE PACKAGE. THIS PIN MUST BE CONNECTED TO GND.

Figure 33. 32-Lead LFCSP\_SS and LFCSP Package Pin Configuration

Table 15. AD2420(W)/AD2426(W)/AD2427(W)/AD2428(W)/AD2429(W) Pin Function Descriptions

Pin No.	Pin Name	Type	Alternate Functions <sup>1</sup>	Description
1	PLLVDD	PWR	None	Power Supply for PLL. PLLVDD can be supplied by $V_{VOUT1}$ .
2, 3	DVDD	PWR	None	Power Supply for Digital Core Logic. DVDD can be supplied by $V_{VOUT1}$ .
4 <sup>2</sup>	SCL	D_IO	None	Serial Clock for I <sup>2</sup> C Data Transfers. Digital input in A <sup>2</sup> B master mode. Digital input (I <sup>2</sup> C slave) or output (I <sup>2</sup> C master) in A <sup>2</sup> B slave mode. This pin uses open-drain I/O cells and must be pulled up to $V_{I2C\_VBUS}$ through a resistor (consult Version 2.1 of the I <sup>2</sup> C bus specification for the proper resistor value). Connect the pin to ground when the I <sup>2</sup> C interface is not used.
5 <sup>2</sup>	SDA	D_IO	None	I <sup>2</sup> C Mode Serial Data. This pin is a bidirectional open-drain input/output and must be pulled up to $V_{I2C\_VBUS}$ through a resistor (consult Version 2.1 of the I <sup>2</sup> C bus specification for the proper resistor value). Connect the pin to ground if the I <sup>2</sup> C interface is not used.
6 <sup>2</sup>	IRQ/IO0	D_IO	None	Interrupt Request Output. In master mode, A <sup>2</sup> B transceivers create event driven interrupt requests towards the host controller. In slave mode, this pin indicates mailbox empty/full status to the slave node processor when mailbox interrupts are enabled. When not serving as an interrupt output pin, this pin serves as a general-purpose I/O pin with interrupt request input capability. The IRQ/IO0 pin must be initialized to become either an input or an output. This pin is high impedance by default.
7 <sup>2</sup>	ADR1/IO1	D_IO	CLKOUT1	The ADR1/IO1 and ADR2/IO2 pins set the I <sup>2</sup> C slave device address during power-on reset; up to four A <sup>2</sup> B master transceiver chips connect to the same I <sup>2</sup> C bus. The ADR1/IO1 pin is high impedance by default. The ADR1/IO1 pin can then be initialized to become a general-purpose input/output (GPIO) pin with interrupt request capability. This pin can be programmed to become a clock output (CLKOUT1). The clock output can be used as a master clock for connected ADCs and DACs or to synchronize switching voltage regulators.

In this table, the Type is defined as follows: PWR = power/ground, A\_IN = analog input, D\_OUT = digital output, A\_IO = analog input/output, D\_IO = digital input/output, N/A = not applicable.



# AD2420(W)/AD2426(W)/AD2427(W)/AD2428(W)/AD2429(W)

**Table 15. AD2420(W)/AD2426(W)/AD2427(W)/AD2428(W)/AD2429(W) Pin Function Descriptions (Continued)**

Pin No.	Pin Name	Type	Alternate Functions <sup>1</sup>	Description
8 <sup>2</sup>	ADR2/IO2	D_IO	CLKOUT2	<p>The ADR1/IO1 and ADR2/IO2 pins set the I<sup>2</sup>C slave device address during power-on reset; up to four A<sup>2</sup>B master transceiver chips connect to the same I<sup>2</sup>C bus. The ADR2/IO2 pin is high impedance by default. The ADR2/IO2 pin can then be initialized to become a general-purpose input/output (GPIO) pin with interrupt request capability.</p> <p>This pin can be programmed to become a clock output (CLKOUT2). The clock output can be used as a master clock for connected ADCs and DACs or to synchronize switching voltage regulators.</p>
9	IOVDD	PWR	None	<p>Power Supply for Digital Input and Output Pins. The digital output pins are supplied from IOVDD, which also sets the highest input voltage that is allowed on the digital input pins. Two I/O voltage ranges are supported (see V<sub>IOVDD</sub> specifications in the <a href="#">Operating Conditions</a> section). The current draw of these pins is variable and depends on the loads of the digital outputs. IOVDD can be sourced by either the VOUT1 or VOUT2 pin. However, if the signals do not originate from logic supplied by the VOUT1 pin or VOUT2 pin, source IOVDD with an external supply.</p>
10	BCLK	D_IO	PDMCLK	<p>Bit Clock. Digital input in master mode. Digital output in slave mode.</p> <p>When using the PDM interface in slave mode, this pin can operate as the clock output (PDMCLK) for PDM microphones (the PDMCLK/IO7 pin can also be used).</p>
11	SYNC	D_IO	None	<p>Synchronization Signal. Digital input in master mode. Digital output in slave mode.</p> <p>For the AD2428W and AD2429W, the SYNC signal frames a multichannel I<sup>2</sup>S/TDM data stream. An A<sup>2</sup>B master node must have a continuous signal because the A<sup>2</sup>B master transceiver derives all clocking information for itself and for the A<sup>2</sup>B bus from this input.</p> <p>When this pin stops toggling, the A<sup>2</sup>B bus resets after a delay. For more information, see <a href="#">Table 3</a>.</p>
12 <sup>2</sup>	DTX0/IO3	D_IO	None	<p>For the AD2428W and ADW2429W, serial I<sup>2</sup>S/TDM data is driven to the DTX0/IO3 pin in multichannel I<sup>2</sup>S/TDM format.</p> <p>This pin serves as the IO3 general-purpose I/O pin when DTX0 function is disabled. The DTX0/IO3 pin is high impedance by default until configured. The pin returns to high impedance when the chip resets due to a missing synchronization signal or low supply voltage.</p> <p>For the ADW2420W, AD2426W, and AD2427W, this pin is GPIO only (IO3).</p>
13 <sup>2</sup>	DTX1/IO4	D_IO	DRX1	<p>For the AD2428W and AD2429W, serial I<sup>2</sup>S/TDM data is driven to the DTX1/IO4 pin in multichannel I<sup>2</sup>S/TDM format.</p> <p>When configured as the alternate DRX1 location, the DTX1/IO4 pin receives data presented in multichannel I<sup>2</sup>S/TDM format. This alternate location can be used when the DRX0/IO5 and DRX1/IO6 pins are used to receive PDM microphone data.</p> <p>This pin serves as the IO4 general-purpose I/O pin when DTX1 and DRX1 functions are disabled. The DTX1/IO4 pin is high impedance by default until configured. The pin returns to high impedance when the chip resets due to a missing synchronization signal or low supply voltage.</p> <p>For the AD2420W, AD2426W, and AD2427W, this pin is GPIO only (IO4).</p>
14 <sup>2</sup>	DRX0/IO5	D_IO	PDM0	<p>For the AD2428W and AD2429W, serial I<sup>2</sup>S/TDM data is received on the DRX0/IO5 pin in multichannel I<sup>2</sup>S/TDM format. This pin is an input for microphone data when enabled as a PDM input (PDM0). This pin serves as the IO5 GPIO pin when DRX0 and PDM0 functions are disabled. The DRX0/IO5 pin is high impedance by default until configured. The pin returns to high impedance when the chip resets due to a missing synchronization signal or low supply voltage.</p> <p>For the AD2420W, AD2426W, and AD2427W, the DRX0 function is not supported.</p>

In this table, the Type is defined as follows: PWR = power/ground, A\_IN = analog input, D\_OUT = digital output, A\_IO = analog input/output, D\_IO = digital input/output, N/A = not applicable.

# AD2420(W)/AD2426(W)/AD2427(W)/AD2428(W)/AD2429(W)

**Table 15. AD2420(W)/AD2426(W)/AD2427(W)/AD2428(W)/AD2429(W) Pin Function Descriptions (Continued)**

Pin No.	Pin Name	Type	Alternate Functions <sup>1</sup>	Description
15 <sup>2</sup>	DRX1/IO6	D_IO	PDM1	For the AD2428W and AD2429W, serial I <sup>2</sup> S/TDM data is received on the DRX1/IO6 pin in multi-channel I <sup>2</sup> S/TDM format. This pin is an input for microphone data when enabled as a PDM input (PDM1). This pin serves as the IO6 GPIO pin when DRX1 and PDM1 functions are disabled. The DRX1/IO6 pin is high impedance by default until configured. The pin returns to high impedance when the chip resets due to a missing synchronization signal or low supply voltage. For the AD2420W, AD2426W, and AD2427W, the DRX1 function is not supported.
16 <sup>2</sup>	PDMCLK/IO7	D_IO	RRSTRB	PDM Microphone Clock Output. In master mode, the PDM clock output (PDMCLK) is used to clock PDM microphones. This pin runs at 64× the SYNC frequency regardless of the BCLK rate used by the host. When using the PDM interface in slave mode, this pin can still operate as the clock output for PDM microphones (PDMCLK), but BCLK can also be used. When PDM functions are disabled, this pin serves as the IO7 GPIO pin. The PDMCLK/IO7 pin can also be used as a strobe to indicate when reduced rate data is updated (RRSTRB). The PDMCLK/IO7 pin is high impedance by default until configured. The pin returns to high impedance when the chip resets due to a missing synchronization signal or low supply voltage.
17	ACM	A_IN	None	Common-Mode Input for Bidirectional, Differential A <sup>2</sup> B Line Transceiver A.
18	AN	A_IO	None	Inverted Pin of Bidirectional, Differential A <sup>2</sup> B Line Driver and Receiver A. Pin 18 is directed towards the master. Pin 18 is self biased.
19	AP	A_IO	None	Noninverted Pin of Bidirectional, Differential A <sup>2</sup> B Line Driver and Receiver A. Pin 19 is directed towards the master. Pin 19 is self biased.
20	ATRXVDD	PWR	None	Power Supply for A <sup>2</sup> B Line Driver and Receiver Circuit. Decouple these pins to VSS with one shared 100 nF capacitor and a shared 10 nF capacitor closest to the pin. The pins can be supplied by VOUT2. Supply the ATRXVDD pin for a master, last slave, or daisy-chained slave.
21	BTRXVDD	PWR	None	Power Supply for A <sup>2</sup> B Line Driver and Receiver Circuit. Decouple these pins to VSS with one shared 100 nF capacitor and a shared 10 nF capacitor closest to the pin. The pins can be supplied by VOUT2. Supply the BTRXVDD pin for a master, last slave, or daisy-chained slave.
22	BP	A_IO	None	For the AD2427W, AD2428W, and AD2429W, this is the noninverted pin of bidirectional, differential A <sup>2</sup> B line driver and Receiver B, which is directed towards the last slave. This pin is self biased.
23	BN	A_IO	None	For the AD2427W, AD2428W, and AD2429W, this is the inverted pin of bidirectional, differential A <sup>2</sup> B line driver and Receiver B, which is directed towards the last slave. This pin is self biased.
24	BCM	A_IN	None	For the AD2427W, AD2428W, and AD2429W, this is the common-mode input for bidirectional, differential A <sup>2</sup> B Line Transceiver B.
25	VSS	PWR	None	Power Supply Pin for Return Currents. Connect the VSS pin to a low impedance local VSS ground plane.
26	VSSN	PWR	None	For the AD2427W, AD2428W, and AD2429W, this is the power supply return current connection for the next slave device. Connect to the inductor that provides the negative bias for the next slave device. The AD2427W, AD2428W, and AD2429W connect VSSN to the local VSS potential to sequence power to the next slave devices in the chain. VSSN automatically disconnects under critical fault conditions.
27	SWP	D_OUT	None	For the AD2427W, AD2428W, and AD2429W, this is the active low open-drain output to drive the gate of a PMOS switch. The switch is open (SWP pin is high) by default. The switch can be closed (SWP pin goes low) to sequence power to the next slave devices in the chain. The switch automatically opens (SWP goes high) under critical fault conditions.
28	SENSE	A_IN	None	Analog input to sense the power supplied to the next slave device. For the AD2420W, AD2426W, or a last in line AD2427W/AD2428W/AD2429W, connect this pin to local ground through a 33 kΩ pull-down resistor.

In this table, the Type is defined as follows: PWR = power/ground, A\_IN = analog input, D\_OUT = digital output, A\_IO = analog input/output, D\_IO = digital input/output, N/A = not applicable.

# AD2420(W)/AD2426(W)/AD2427(W)/AD2428(W)/AD2429(W)

**Table 15. AD2420(W)/AD2426(W)/AD2427(W)/AD2428(W)/AD2429(W) Pin Function Descriptions (Continued)**

Pin No.	Pin Name	Type	Alternate Functions <sup>1</sup>	Description
29	VOUT2	PWR	None	Second Output of the On-Chip low Dropout Voltage Regulator. The voltage output on this pin provides a regulated supply to the TRXVDD supply pins. External devices also can be powered by this supply if the current consumption is within the specification. Decouple VOUT2 to VSS with a 4.7 $\mu$ F capacitor.
30	VIN	PWR	None	Power supply pin that accepts a wide input voltage range (see the $V_{VIN}$ specification in the <a href="#">Operating Conditions</a> section) for an on-chip low dropout voltage regulator.
31	VSS	PWR	None	Power Supply Pin for Return Currents. Connect the VSS pin to a low impedance local VSS ground plane.
32	VOUT1	PWR	None	First Output of the On-Chip Low Dropout Voltage Regulator. The voltage output on this pin provides a regulated supply to the DVDD and PLLVDD power supply pins. External devices can be powered by this supply if the current consumption is within the specification. Decouple VOUT1 to VSS with a 4.7 $\mu$ F capacitor.
33	EPAD	PWR	None	Power Supply Pin for Return Currents. See other VSS pin description in this table. This pin is the exposed pad on the bottom of the package and must be connected to GND.

In this table, the Type is defined as follows: PWR = power/ground, A\_IN = analog input, D\_OUT = digital output, A\_IO = analog input/output, D\_IO = digital input/output, N/A = not applicable.

<sup>1</sup> See the AD2420(W)/6(W)/7(W)/8(W)/9(W) *Automotive Audio Bus A<sup>2</sup>B Transceiver Technical Reference* for more information about configuring pins for alternate functions.

<sup>2</sup> If the listed functions for this pin are not required, do not connect this pin.

## POWER ANALYSIS

This section provides information on power consumption of the A<sup>2</sup>B system. The intent of power dissipation calculations is to assist board designers in estimating power requirements for power supply and thermal relief designs.

Power dissipation on an A<sup>2</sup>B node depends on various factors, such as the required external peripheral supply current and bus activity. An A<sup>2</sup>B system can be comprised of a mix of bus powered slaves and local powered slaves. A bus powered slave derives power from the A<sup>2</sup>B bus wires. A local powered slave derives power from separate power wires. Power estimation for a bus powered system is more complex when compared to a local powered system. For power analysis, A<sup>2</sup>B systems with both local and bus powered slaves must be divided into segments of nodes that draw from the same power supply.

### CURRENT FLOW

Figure 34 describe key parameters and equations to calculate power dissipation on the transceiver. The current flow on an A<sup>2</sup>B node incorporates the described current paths.

- Constant current
  - $I_{PLLVD D}$  — PLL supply current
  - $I_{VINQ}$  — VIN quiescent current
  - I<sup>2</sup>C I/O current
  - $I_{IOVDD}$  — I<sup>2</sup>S/TDM/PDM I/O current
  - $I_{VEXT1}$  or  $I_{VEXT2}$  — peripheral supply currents
- $I_{DVDD}$  — digital logic supply current
- $I_{TRXVDD}$  — A<sup>2</sup>B bus TX/RX current
  - LVDS transceiver supply currents of A and B transceivers — transmit LVDS TX and receive LVDS RX

I<sup>2</sup>C activity and the resulting I/O current is considered negligible when compared to other currents. Therefore, the on-chip I<sup>2</sup>C I/O current is not considered when calculating the current consumption.

### Constant Current

All currents that are not influenced directly by A<sup>2</sup>B bus activity on other nodes fall under the category of constant current.

### PLL Supply Current

The PLL supply current is specified as  $I_{PLLVD D}$ , which is the static current in an active transceiver.

### VIN Quiescent Current

The VIN quiescent current is specified as the static current  $I_{VINQ}$ . It is independent of the load and does not include any power drawn from the voltage regulator output pins.

### IOVDD Current

The on-chip I<sup>2</sup>S/TDM/PDM I/O current  $I_{IOVDD}$  is based on dynamic switching currents on the BCLK, SYNC, DTX0, DTX1, DRX0, and DRX1 pins.

The dynamic current, due to switching activity on an output pin, is calculated using the following equation:

$$\text{Output Dynamic Current} = (C_{PDout} + C_L) \times V_{IOVDD} \times f$$

where:

$C_{PDout}$  = dynamic, transient power dissipation capacitance internal to the transceiver output pins.

$C_L$  = total load capacitance that an output pin sees outside the transceiver.

$V_{IOVDD}$  = voltage on a digital pin.

$f$  = frequency of switching on the pin.

The dynamic current, due to switching activity on an input pin, is calculated using the following equation:

$$\text{Input Dynamic Current} = C_{PDin} \times V_{IOVDD} \times f$$

where:

$C_{PDin}$  = dynamic, transient power-dissipation capacitance internal to the input pins of the transceiver.

$I_{IOVDD}$  = the sum of input and output dynamic currents of all pins internally supplied by the IOVDD pin.

$f$  = frequency of switching on the pin.

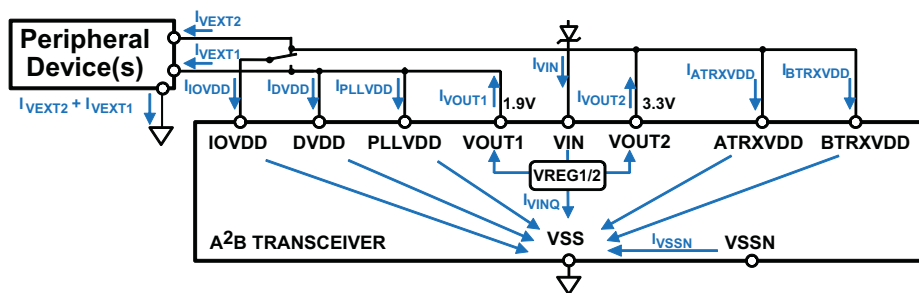

Figure 34. Current Flow Model

## Peripheral Supply Current

Peripheral components that are external to the transceiver also can be supplied through the voltage regulator outputs of  $V_{VOUT1}$  and  $V_{VOUT2}$ .  $V_{VOUT1}$  can supply the current specified as  $I_{VEXT1}$  to external devices.  $V_{VOUT2}$  can supply the current specified as  $I_{VEXT2}$  to external devices.

When bus powered, peripheral supply current draw has a direct impact on other nodes in the system. It is important to stay within the thermal package limits and not exceed the specification limits of  $I_{VSSN}$  and  $V_{VIN}$  in any of the A<sup>2</sup>B bus nodes.

## Digital Logic Supply Current

The digital logic supply current  $I_{DVDD}$  is a combination of static current consumption and digital TX/RX current.

## A<sup>2</sup>B Bus TX/RX Current

The level of A<sup>2</sup>B bus activity directly influences current consumption on both the LVDS transceivers related to A<sup>2</sup>B transmitter and receiver processing.

## LVDS Transmitter and Receiver Supply Currents

The current  $I_{TRXVDD}$  depends on  $I_{TXVDD}$  and  $I_{RXVDD}$  at 100% activity level and A<sup>2</sup>B bus activity:

- Downstream LVDS transceiver current
  - B transceiver  $I_{BTXVDD}$  LVDS TX current results from downstream TX activity level of the current node.
  - A transceiver  $I_{ARXVDD}$  LVDS RX current results from downstream activity level of the previous node.
- Upstream LVDS transceiver current
  - A transceiver  $I_{ATXVDD}$  LVDS TX current results from A side upstream activity level of the current node.
  - B transceiver  $I_{BRXVDD}$  LVDS RX current results from upstream activity level of the next in line node.

## Downstream/Upstream Activity Level

The activity level for downstream data of TRX B is determined by the following:

- Header bits for downstream. A<sup>2</sup>B systems use 64 downstream header bits referred to as a synchronization control frame (SCF).
- The number of downstream data bits transmitted in a node = the number of downstream transmitted slots × (bits per slot + parity bit) where the parity bit = 1. The number of downstream transmitted slots does not include the locally consumed slots.
- B side downstream transmitter activity level of a node. (SCF bits + number of downstream transmitted data bits) ÷ 1024.

The activity level for upstream data of TRX A is determined by the following:

- Header bits for upstream. (SRF bits + total number of received downstream data bits) ÷ 1024.

- The number of upstream data bits transmitted in a node = number of upstream transmitted slots × (bits per slot + parity bit) where the parity bit = 1. The number of upstream transmitted slots is the sum of received upstream slots and locally contributed slots.
- A side upstream transmitter activity level of a node. (SRF bits + number of transmitted upstream data bits) ÷ 1024.

## LVDS Transmitter and Receiver Idle Current

The idle current,  $I_{TRXVDD\_IDLE}$ , depends on  $I_{TXVDD}$  and  $I_{RXVDD}$  at 0% activity level and A<sup>2</sup>B bus idle time.

- B transceiver idle current. B Transceiver  $I_{BTRXVDD\_IDLE}$  LVDS current results from B transceiver idle time.
- A transceiver idle current. A Transceiver  $I_{ATRXVDD\_IDLE}$  LVDS current results from A transceiver idle time.
- B transceiver idle time. B transceiver idle time is the time when both the TX and RX of the B transceiver are idle.

The idle time of the B transceiver is derived by eliminating the following activity levels from the B transceiver frame cycle:

- B transceiver downstream activity level of the current node.
- A transceiver upstream activity level of the next in line node.
- A transceiver idle time is the time when both the TX and RX of the A transceiver are idle.

The idle time of the A transceiver is derived by eliminating the following activity from the A transceiver frame cycle:

- A transceiver upstream activity level of the current node.
- B transceiver downstream activity level of previous node.

The sum of the LVDS transceiver currents is

$$I_{TRXVDD} = I_{BRXVDD} + I_{BTXVDD} + I_{ARXVDD} + I_{ATXVDD} + I_{BTRXVDD\_IDLE} + I_{ATRXVDD\_IDLE}$$

## VREG1 AND VREG2 OUTPUT CURRENTS

Voltage regulator output currents are governed by the following equations:

$I_{VOUT2}$  is the current from  $V_{VOUT2}$  which is the sum of the LVDS transmitter and receiver supply currents, peripheral supply currents, and I/O current.

$$I_{VOUT2} = I_{TRXVDD} + I_{IOVDD} + I_{VEXT2}$$

$I_{VOUT1}$  is the current from the  $V_{OUT1}$  pin which is the sum of PLL supply current,  $I_{PLLVD}$ , digital logic supply current  $I_{DVDD}$ , peripheral supply current,  $I_{VEXT1}$ , and I<sup>2</sup>S/TDM/PDM I/O current  $I_{IOVDD}$ .

$$I_{VOUT1} = I_{PLLVD} + I_{VEXT1} + I_{DVDD} + I_{IOVDD}$$

$I_{IOVDD}$  in a slave node can be sourced by either  $I_{VOUT1}$  or  $I_{VOUT2}$  but not both, depending on whether  $I_{IOVDD}$  is supplied from  $V_{VOUT1}$  or  $V_{VOUT2}$ .

# AD2420(W)/AD2426(W)/AD2427(W)/AD2428(W)/AD2429(W)

## CURRENT AT VIN ( $I_{VIN}$ )

The current at the VIN pin ( $I_{VIN}$ ) of the transceiver is the sum of currents  $I_{VOUT1}$  and  $I_{VOUT2}$  and the quiescent current, shown in Figure 34 and in the following equation:

$$I_{VIN} = I_{VOUT1} + I_{VOUT2} + I_{VINQ}$$

The A side node current is the line bias current from an earlier node. In a bus powered node, it is also the power supply current and a portion of this current supplies the next in line nodes.

$$I_A = I_{VIN} + I_B + I_{VREGPERI}$$

where:

$I_B$  = B side current to the next node (=  $I_{VSSN}$  return current and  $I_A$  of the next in line node).

$I_{VREGPERI}$  = peripheral current supplied from  $I_A$  by extra voltage regulator, external to the transceiver (not illustrated in Figure 35 and Figure 36).

## POWER DISSIPATION

The power dissipation of the transceiver is calculated using the following equation:

$$Power = I_{VIN} \times V_{VIN} + (I_{VSSN})^2 \times R_{VSSN} - I_{VEXT1} \times V_{VOUT1} - I_{VEXT2} \times V_{VOUT2}$$

where:

$I_{VIN}$  = current at VIN pin.

$V_{VIN}$  = voltage at VIN pin.

$I_{VSSN}$  = B side current  $I_B$  to the next node and return current from the next node. The next node is the node connected to the B terminal of the current node. See Figure 35.

$R_{VSSN}$  = internal  $V_{SSN}$  on resistance (see Table 16).

$I_{VEXT1}$  = peripheral supply current from  $V_{VOUT1}$ .

$I_{VEXT2}$  = peripheral supply current from  $V_{VOUT2}$ .

$V_{VOUT1}$  = output voltage from  $V_{REG1}$ .

$V_{VOUT2}$  = output voltage from  $V_{REG2}$ .

## RESISTANCE BETWEEN NODES

Figure 35 shows the dc model of a system with a combination of local and bus powered  $A^2B$  slaves.

A voltage drop of the dc bias is observed between the  $A^2B$  nodes, due to resistance and current consumption. Table 16 lists the causes of the dc resistance between nodes ( $R_{BETWEEN}$ ) with example resistance values.

Both bias supply and return currents are subject to resistance. Therefore, some resistance values must be doubled (for example, wire length resistance).

Table 16. Breakdown/Budget of Typical DC Resistance Between Nodes

Resistance	Each	Qty	Total	Unit
Inductor DC Resistance	0.26	4	1.04	$\Omega$
Short Circuit Protection Resistor	1.05	1	1.05	$\Omega$
Positive Bias PMOS Switch On-Resistance	0.11	1	0.11	$\Omega$
Negative Bias Switch On-Resistance $R_{VSSN}$	1.2	1	1.2	$\Omega$
Resistance of Connections	0.01	4	0.04	$\Omega$
Total $R_{SUM}$	N/A <sup>1</sup>	N/A <sup>1</sup>	2.39	$\Omega$
Wire Length Resistance of Cable	0.121	2	0.242	$\Omega/m$

<sup>1</sup> N/A means not applicable.

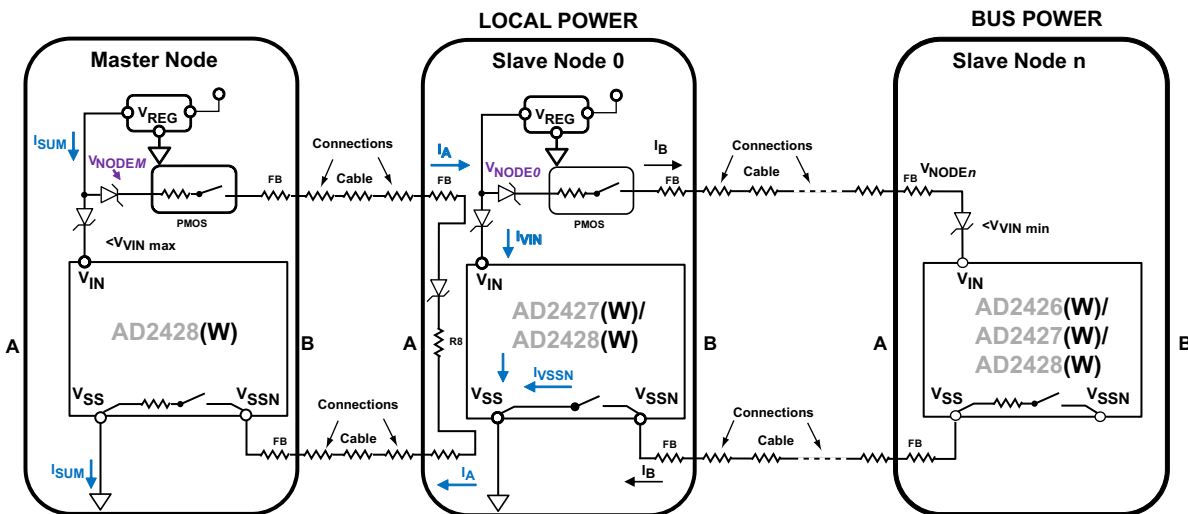

Figure 35.  $A^2B$  DC Power Model for a System with Local and Bus Powered Slaves

## VOLTAGE REGULATOR CURRENT IN MASTER NODE OR LOCAL POWERED SLAVE NODE

The bus power, required from a local powered node (master node) for powering all nodes in the system, is calculated using the following equation:

$$I_{SUM} = I_{VIN} + I_{VSSN} + I_{INRUSH} + I_{VREGPERI}$$

where:

$I_{VIN}$  is the current to  $V_{VIN}$  of the local powered mode.

$I_{VSSN}$  is the return current from next in line slave node. It is equal to the  $I_A$  current supplied to the next in line node.

$I_{INRUSH}$  is the inrush current required to charge capacitors on the VIN pin at power-up.

$I_{VREGPERI}$  is the input current of extra  $V_{REG}$  for peripherals (not illustrated in Figure 35 and Figure 36).

Analog Devices recommends a minimum  $I_{INRUSH}$  of 150 mA to support the components shown in the reference schematics. The selected voltage regulator must be sized to meet  $I_{SUM}$  for the application.

$I_{VSSN}$  current is below 2 mA when the next in line node is a local powered slave with a circuit-based on the [Designer Reference](#) section. The  $I_{SUM}$  current in most applications is less than 100 mA if the next in line node is a local powered slave node.

More current,  $I_{VSSN}$ , is drawn if the next in line node uses bus power. The  $I_{VSSN}$  maximum specification limits the bus power draw of slave nodes, especially in a line of bus powered slaves.

## POWER DISSIPATION OF A<sup>2</sup>B BUS

The power dissipation of an A<sup>2</sup>B system is calculated as follows:

$$\text{Power Dissipation} = I_{SUM} \times V_{VIN} \text{ of master.}$$

## POWER ANALYSIS OF BUS POWERED SYSTEM

Figure 36 shows the dc model for a bus powered A<sup>2</sup>B system.

Power equations in this data sheet are used for power calculations in the SigmaStudio<sup>®</sup> software. The power equations are also available in an Excel spreadsheet, provided by technical support upon request.

## SUPPLY VOLTAGE

The supply voltage ( $V_{VIN}$ ) level on a bus powered transceiver is predictable and can be calculated using the following equations derived from Figure 36.

For the master node, the supply voltage is calculated as,

$$V_{NODEM} = V_{REGM} - V_{DIODE3}$$

$$V_{VIN} = V_{REGM} - V_{DIODE1} \text{ for master}$$

For a slave node, the supply voltage is calculated as,

$$V_{NODE} = V_{NODE'} - I_A \times R_{BETWEEN}$$

$$V_{VIN} = V_{NODE} - V_{DIODE1}$$

where:

$V_{NODE'}$  is the  $V_{NODE}$  voltage potential of the earlier node. The earlier node is the node connected to the A side transceiver of the current node.

$R_{BETWEEN}$  is the connection resistance between the current and earlier node, described in the [Resistance Between Nodes](#) section.  $V_{DIODE}$  is the voltage drop of the Shottkey reverse polarity protection diode.

$I_A$  is the current that a bus powered slave node draws from an earlier node.

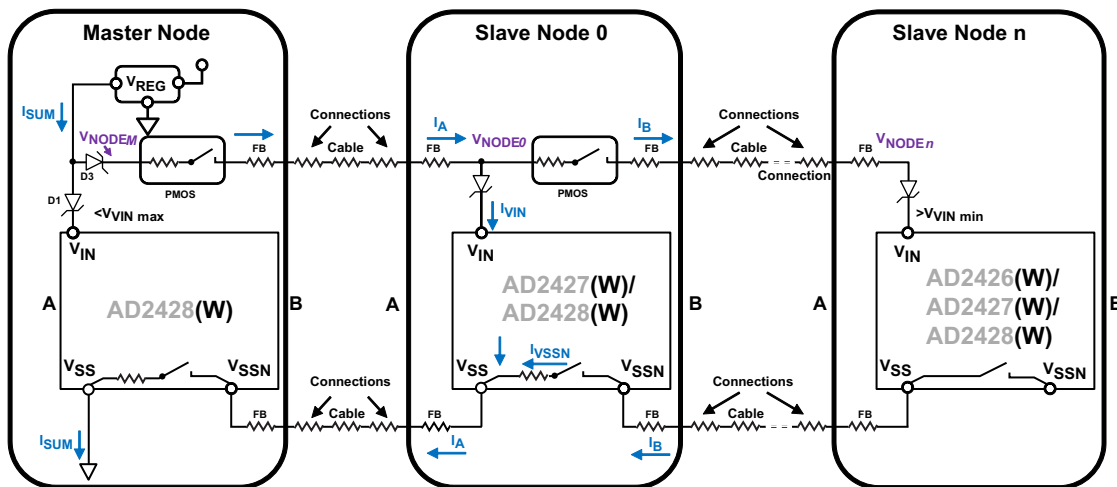

Figure 36. A<sup>2</sup>B Power Model for Bus Powered System

For a system with all in-line bus powered nodes,  $I_A$  is calculated cumulatively from the last in-line node as

$$I_A = I_{VIN} + I_B$$

where:

$I_A$  = current that a bus powered slave node draws from an earlier node.

$I_{VIN}$  = current at VIN pin.

$I_B$  = B side return current from the next in line node. The next in line node is the node connected to the B terminal of the current node.

## REDUCING POWER CONSUMPTION

The following sections describe three methods that reduce power consumption.

### Power-Down Mode

Any node in an A<sup>2</sup>B bus powered system can be shut down by disconnecting the power supply in the previous slave node (towards the master). Disconnecting a slave from the power supply also powers down all of the following slaves (towards the last slave).

### Standby Mode

The A<sup>2</sup>B bus enters standby mode by setting the AD242X\_DATCTL.STANDBY bit of the master. The SCF in standby mode is 19 bits long, instead of 64 bits. In standby mode, there is no upstream and no downstream traffic on the A<sup>2</sup>B bus, and only a minimal SCF keeps all the slave nodes synchronized. This keeps the A<sup>2</sup>B bus power in the lowest power state while maintaining clock synchronization between nodes. Using the equations in the [Downstream/Upstream Activity Level](#) section, the bus activity level in standby mode is,

- Downstream activity level =  $19 \div 1024 = 1.9\%$
- Upstream activity level =  $0\%$

The digital transceiver current, including the LVDS TX and RX current, are subject to the activity levels. The LVDS TX and RX current also are subject to idle current during the bus idle time.

### Control Mode

In control mode, there are no data channels in a superframe. The superframe only has the 64-bit SCF and SRF in the frame with the control data embedded in the header bits. Therefore, the A<sup>2</sup>B bus power is less when compared to normal mode, which has data channels in the superframe. Using the equations in the [Downstream/Upstream Activity Level](#) section, the bus activity level in control mode is,

- Bus activity level downstream =  $64 \div 1024 = 6.3\%$
- Bus activity level upstream =  $64 \div 1024 = 6.3\%$

The LVDS TX and RX current also are subject to idle current during the bus idle time.

## THERMAL POWER

When calculating power, system designers must consider thermal power. Thermal power calculations are based on the package thermal characteristics, shown in the following equation:

$$\theta_{JA} = \text{thermal resistance}$$

$$(T_J - T_A) \div \text{power [}^\circ\text{C/W]} \text{ with airflow} = 0 \text{ m/s}$$

[Table 17](#) provides the thermal power allowance example. These values are derived from a JEDEC standard 2S2P test board.  $\theta_{JA}$  values vary significantly and depend on system design and conditions. For the example calculation in [Table 17](#), the  $\theta_{JA}$  value provided is determined using the JEDEC standard conditions.

In this example ([Table 17](#)), a slave node with 292 mW of power dissipation is used to provide the maximum estimated power. The margin is calculated by subtracting the maximum estimated power from the thermal power allowance.

**Table 17. Thermal Power Allowance Example**

Parameter	Example Value	Unit
$T_A$	105	$^\circ\text{C}$
$T_J$	125	$^\circ\text{C}$
Delta ( $T_J - T_A$ )	20	$^\circ\text{C}$
Example $\theta_{JA}$	31.6	$^\circ\text{C/W}$
Maximum Allowed Thermal Power	633	mW
Maximum Estimated Power	292	mW
Power Margin	341	mW



## DESIGNER REFERENCE

The following sections provide descriptions and layouts of some typical node configurations.

An A<sup>2</sup>B-compliant master transceiver requires external components to pass EMC and ESD tests in the automotive environment and support full line diagnostics functionality. Diodes are required for correct line diagnostics and to prevent damage under line fault conditions. The master circuit must also supply bias voltage for line diagnostics and power supply to bus powered slaves.

An A<sup>2</sup>B-compliant, last in the line, local powered, slave node transceiver requires external components to pass EMC and ESD tests in the automotive environment. The circuit must allow for full line diagnostics with properly terminated A<sup>2</sup>B bus bias and properly terminated signals. The circuit must also electrically isolate the local powered slave node from the earlier node to prevent line faults triggered by the formation of ground loops across power and communication wires.

An A<sup>2</sup>B-compliant, local powered, slave node transceiver requires external components to pass EMC and ESD tests in the automotive environment. The circuit must allow for full line diagnostics with properly terminated A<sup>2</sup>B bus bias and properly terminated signals (A-side). The local powered slave node regenerates the bias voltage from its local supply and provides it to the next node (B-side) for line diagnostics and as a voltage supply for bus powered nodes. Diodes are required for correct line diagnostics and damage prevention under line fault conditions.

An A<sup>2</sup>B-compliant, bus powered, slave node transceiver requires external components to pass EMC and ESD tests in the automotive environment. The circuit must use the A<sup>2</sup>B bias (A-side) as its low-pass filtered supply voltage (using inductors and capacitors). A<sup>2</sup>B communication signals must be separated from the dc content at the A-side transceiver by high-pass filtering with ac coupling capacitors. Capacitors must also be used on the B-side where the ac-coupled signal is merged with the recovered bias, which is supplied through ac signal blocking inductors. The bus powered slave node must include circuitry to forward the recovered bias voltage to the next node and to perform line diagnostics. A diode is required for correct line diagnostics and damage prevention under line fault conditions.

Contact your local Analog Devices representative for the latest schematic circuit recommendations and bill of materials for each of these node configurations. The recommended circuit and component selection must be followed for A<sup>2</sup>B automotive-grade compliance.

### V<sub>SENSE</sub> AND CONSIDERATIONS FOR DIODES

The relative difference between the voltage on the VIN pin, V<sub>VIN</sub>, and the A<sup>2</sup>B bus bias voltage, V<sub>SENSE</sub>, is monitored by the SENSE pin under steady state normal operating conditions. The range must be within the values described in Table 18 for all line diagnostics to function correctly.

Table 18. V<sub>VIN</sub> to V<sub>SENSE</sub> Range

Range	Min	Max	Unit
V <sub>VIN</sub> to V <sub>SENSE</sub>	-0.6	+0.5	V

The difference between V<sub>VIN</sub> and V<sub>SENSE</sub> is primarily influenced by diode voltage drops and the on resistance of the PMOS. (Contact your local Analog Devices representative for the latest schematic circuit recommendations and bill of materials.)

Table 19 identifies which diodes cause voltage drops for each node type.

Table 19. V<sub>VIN</sub> to V<sub>SENSE</sub> Voltage Dependencies

Node Type	V <sub>VIN</sub> to V <sub>SENSE</sub> Diode Dependencies
Master	D1, D3
Locally Powered Slave	D1, D3
Bus Powered Slave	D1

### OPTIONAL ADD ON CIRCUITS

An earlier node in the sequence can remotely power up the next locally powered slave node over the A<sup>2</sup>B bus by switching the bias voltage onto the A<sup>2</sup>B bus. The local powered slave node can sense this bias voltage and use it as an enable input for power switches or voltage regulators to awake the device from a very low current sleep mode.

An optocoupler, shown in Figure 37, can differentiate input of the bias voltage and ensures that the locally powered slave node is electrically isolated. This avoids ground loops that can induce noise and also trigger line fault detection. Current during sleep is determined by the optocoupler transistor off current, the resistor to ground (R12), and the power switch enable circuit.

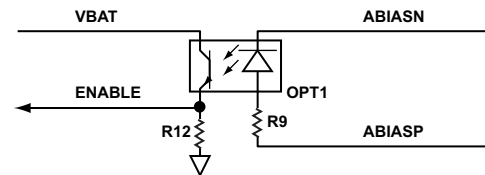

Figure 37. Optional Power Supply Enable Circuit with Optocoupler

## LAYOUT GUIDELINES

The transceivers are highly integrated devices, comprising both digital sections for audio data, clocks, PLL, and analog A<sup>2</sup>B transceiver sections. Use the following design rules to maximize performance and signal integrity:

- Solder the exposed paddle underneath the transceiver effectively to the PCB where it is locally connected to the ground plane. [Figure 38](#) shows transceiver foot print, recommended solder mask (matching exposed paddle), paste mask (dividing exposed paddle), and stitching of the ground plane.  
The solder paste under the exposed paddle is split into four square areas, which minimizes solder wicking through uncovered thermal vias and prevents sliding or tilting of the chip during solder reflow. See [Soldering Considerations for Exposed-Pad Packages \(EE-352\)](#), on the Analog Devices web site. The exposed paddle is used for a thermal pathway as well as for electrical connection.
- Place power supply decoupling capacitors as close as possible to the transceiver chip with the smallest value capacitor being closest to the pin.
- Route all traces as short as possible, especially the AP/AN and BP/BN signals.
- Symmetrically route the AP/AN and BP/BN signals to suppress EMC. Match routing parasitic capacitance and inductance.
- Symmetrically shield the AP/AN and BP/BN signals with ground. Use shields that are at least 0.5 mm wide and stitched generously with vias to the GND plane. Symmetry is best achieved with flooded plane areas.
- Do not route switching signals or power supply traces next to or underneath the AP/AN and BP/BN signals.
- Avoid using trace stubs, especially if they create an asymmetry on the AP/AN and BP/BN signals. Symmetrically route into and out of pads rather than branch out.
- Differential impedance trace of the AP/AN and BP/BN signals should be  $100\ \Omega \pm 10\%$  (10 MHz to 100 MHz) on both sides of the common-mode choke.
- Avoid unnecessary layer transitions for the AP/AN and BP/BN signals. Match necessary layer transitions for differential signals.
- Use an impedance of  $50\ \Omega \pm 10\%$  to ground on all traces.
- Magnetically separate common-mode chokes from each other by at least 2 mm.
- Do not route ground or other signals on any layer underneath the common-mode chokes. Extend this exclusion at least 2 mm from between the pads.
- For shielded wires, connect the shield to the local ground.
- Place one side of the inductors in the signal path and bridge dc signals to the power and ground nets.
- Place termination resistors symmetrically and close to the common-mode chokes.

- Where possible, flood unused PCB areas with connected ground planes on all layers.
- Stitch ground planes at least every 5 mm.
- Do not obstruct power supply and ground return paths by vias.
- Use series resistors ( $\geq 33\ \Omega$ ) near the source of clock and fast data signals. Also consider footprints for small filter capacitors for such signal traces.
- Avoid using right angle bends in signal routing. Use rounded or 45 degree mitered bends instead.
- Use shortest possible signal path on connectors (inner row of multirow, right angled connectors).
- On multipin connectors, provide at least 3 mm spacing around differential A<sup>2</sup>B pin pairs to ensure that A<sup>2</sup>B signal pairs are closer to each other than to adjacent signals. The spacing improves EMC performance.  
Use low impedance static signals (ground) symmetrically on connector pins adjacent to the A<sup>2</sup>B bus pairs when tight spacing is required.

# AD2420(W)/AD2426(W)/AD2427(W)/AD2428(W)/AD2429(W)

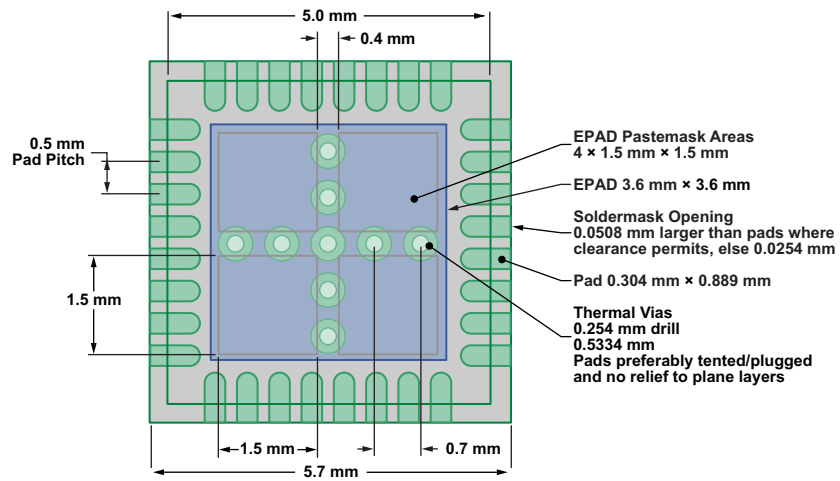
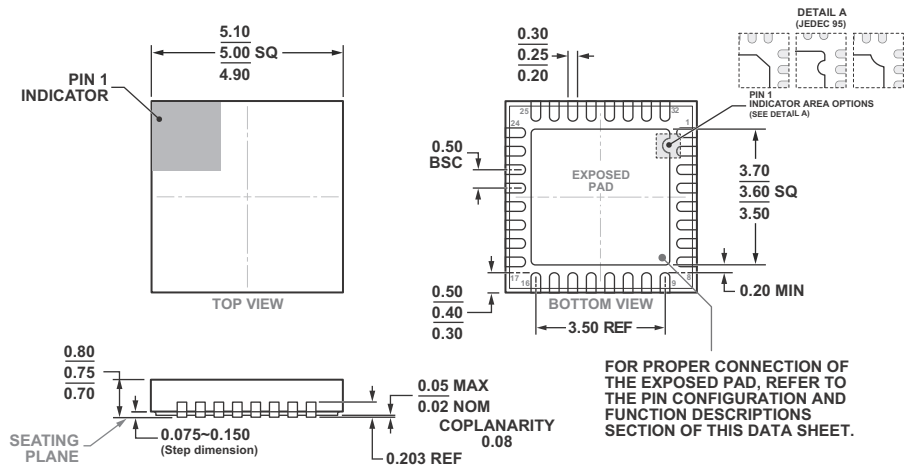

Figure 38. Transceiver Footprint

# AD2420(W)/AD2426(W)/AD2427(W)/AD2428(W)/AD2429(W)

## OUTLINE DIMENSIONS

Figure 39 shows the outline dimensions for the 32-Lead LFCSP\_SS (CS-32-2) for the released products found in the [Ordering Guide](#): AD2426W/AD2427W/AD2428W.



# AD2420(W)/AD2426(W)/AD2427(W)/AD2428(W)/AD2429(W)

Figure 40 shows the outline dimensions for the 32-Lead LFCSP (CP-32-12) for the unreleased products found in the [Pending Products](#) table: AD2420/AD2420W/AD2426/AD2427/AD2428/AD2429/AD2429W.

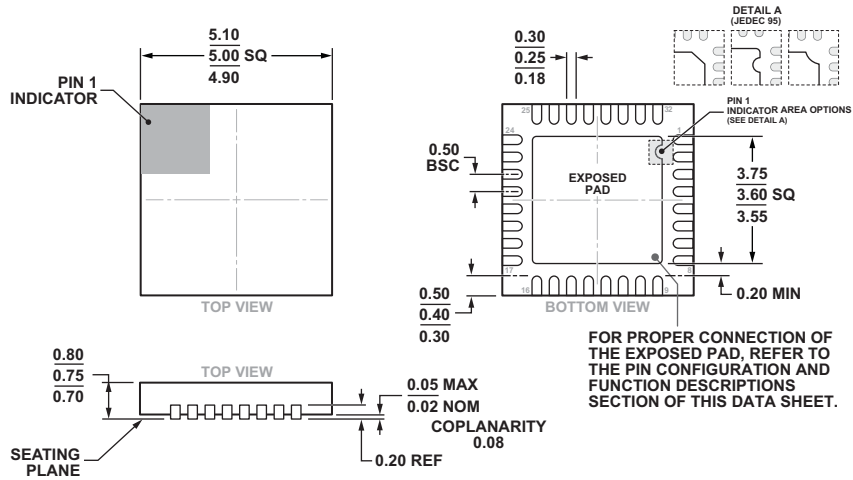

COMPLIANT TO JEDEC STANDARDS MO-220-WHHD-5

Figure 40. 32-Lead Lead Frame Chip Scale Package [LFCSP]  
5 mm x 5 mm Body and 0.75 mm Package Height  
(CP-32-12)  
Dimensions shown in millimeters

# AD2420(W)/AD2426(W)/AD2427(W)/AD2428(W)/AD2429(W)

## ORDERING GUIDE

Model <sup>1, 2, 3</sup>	Temperature Range <sup>4</sup>	Description	Package Option
AD2426WCCSZ	-40°C to +105°C	32-Lead Frame Chip Scale Package [LFCSP_SS]	CS-32-2
AD2426WCCSZ-RL	-40°C to +105°C	32-Lead Frame Chip Scale Package [LFCSP_SS]	CS-32-2
AD2427WCCSZ	-40°C to +105°C	32-Lead Frame Chip Scale Package [LFCSP_SS]	CS-32-2
AD2427WCCSZ-RL	-40°C to +105°C	32-Lead Frame Chip Scale Package [LFCSP_SS]	CS-32-2
AD2428WCCSZ	-40°C to +105°C	32-Lead Frame Chip Scale Package [LFCSP_SS]	CS-32-2
AD2428WCCSZ-RL	-40°C to +105°C	32-Lead Frame Chip Scale Package [LFCSP_SS]	CS-32-2

<sup>1</sup>Z = RoHS Compliant Part.

<sup>2</sup>W = Qualified for Automotive Applications.

<sup>3</sup>RL = Supplied on Tape and Reel.

<sup>4</sup>Referenced temperature is ambient temperature. The ambient temperature is not a specification. See the [Operating Conditions](#) section for junction temperature (T<sub>J</sub>) specification which is the only temperature specification.

## AUTOMOTIVE PRODUCTS

The AD2426W/AD2427W/AD2428W models are available with controlled manufacturing to support the quality and reliability requirements of automotive applications. Note that these automotive models may have specifications that differ from the nonautomotive models; therefore, designers should review the [Specifications](#) section of this data sheet carefully. Only the automotive grade products shown in the [Ordering Guide](#) are available for use in automotive applications. Contact your local Analog Devices account representative for specific product ordering information and to obtain the specific Automotive Reliability reports for these models.

# AD2420(W)/AD2426(W)/AD2427(W)/AD2428(W)/AD2429(W)

## PENDING PRODUCTS

Model <sup>1</sup>	Temperature Range <sup>2</sup>	Description	Package Option
AD2420KCPZ	0°C to +70°C	32-Lead Frame Chip Scale Package [LFCSP]	CP-32-12
AD2420BCPZ	-40°C to +85°C	32-Lead Frame Chip Scale Package [LFCSP]	CP-32-12
AD2420WCCPZ01	-40°C to +105°C	32-Lead Frame Chip Scale Package [LFCSP]	CP-32-12
AD2420WCCPZ01-RL	-40°C to +105°C	32-Lead Frame Chip Scale Package [LFCSP]	CP-32-12
AD2426KCPZ	0°C to +70°C	32-Lead Frame Chip Scale Package [LFCSP]	CP-32-12
AD2426BCPZ	-40°C to +85°C	32-Lead Frame Chip Scale Package [LFCSP]	CP-32-12
AD2426WCCSZ01	-40°C to +105°C	32-Lead Frame Chip Scale Package [LFCSP_SS]	CS-32-2
AD2426WCCSZ01-RL	-40°C to +105°C	32-Lead Frame Chip Scale Package [LFCSP_SS]	CS-32-2
AD2427KCPZ	0°C to +70°C	32-Lead Frame Chip Scale Package [LFCSP]	CP-32-12
AD2427BCPZ	-40°C to +85°C	32-Lead Frame Chip Scale Package [LFCSP]	CP-32-12
AD2427WCCSZ01	-40°C to +105°C	32-Lead Frame Chip Scale Package [LFCSP_SS]	CS-32-2
AD2427WCCSZ01-RL	-40°C to +105°C	32-Lead Frame Chip Scale Package [LFCSP_SS]	CS-32-2
AD2428KCPZ	0°C to +70°C	32-Lead Frame Chip Scale Package [LFCSP]	CP-32-12
AD2428BCPZ	-40°C to +85°C	32-Lead Frame Chip Scale Package [LFCSP]	CP-32-12
AD2428WCCSZ01	-40°C to +105°C	32-Lead Frame Chip Scale Package [LFCSP_SS]	CS-32-2
AD2428WCCSZ01-RL	-40°C to +105°C	32-Lead Frame Chip Scale Package [LFCSP_SS]	CS-32-2
AD2429KCPZ	0°C to +70°C	32-Lead Frame Chip Scale Package [LFCSP]	CP-32-12
AD2429BCPZ	-40°C to +85°C	32-Lead Frame Chip Scale Package [LFCSP]	CP-32-12
AD2429WCCPZ01	-40°C to +105°C	32-Lead Frame Chip Scale Package [LFCSP]	CP-32-12
AD2429WCCPZ01-RL	-40°C to +105°C	32-Lead Frame Chip Scale Package [LFCSP]	CP-32-12

<sup>1</sup>Z = RoHS Compliant Part.

<sup>2</sup>Referenced temperature is ambient temperature. The ambient temperature is not a specification. See the [Operating Conditions](#) section for junction temperature (T<sub>j</sub>) specification which is the only temperature specification.

<sup>2</sup>C refers to a communications protocol originally developed by Philips Semiconductors (now NXP Semiconductors).