



Datasheet

RS PRO 2 MTR PS2 Male & SVGA Male - PS2 Female & SVGA Female KVM Cable

Stock number: 182-8852

EN

The RSPRO PS2 male and SVGA male to PS2 female and SVGA female KVM cable has a beige PVC cable jacket, the SVGA connector has beige hoods, the PS2 mouse connectors have green hoods and the PS2 keyboard connectors have purple hoods.

This cable is used to connect a KVM to a PC. Checking the ports on the KVM to ensure that the correct gender of cable is advised.

Each connector is independently wired pin to pin and care must be taken to ensure that your KVM does not use a proprietary wiring.

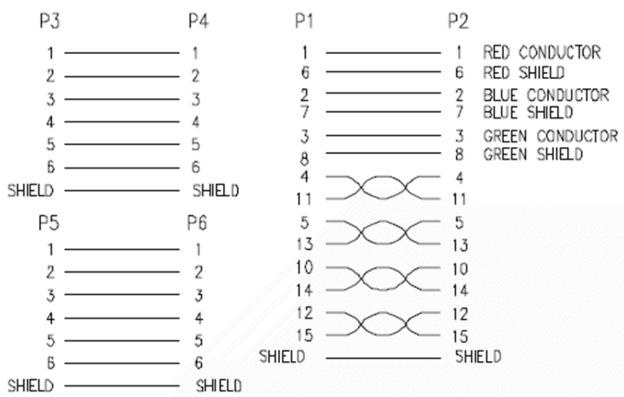
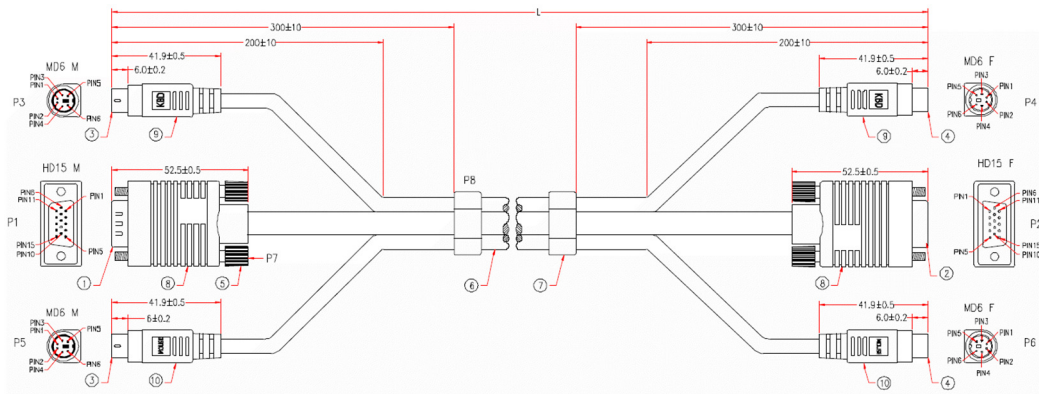

10	BLACK HEAT SHRINK TUBE $\phi 1.0 \times 12\text{mm}$
	MOLDED PE COLOR TRANSPARENT
	MOLDED PVC GREEN <MOUSE>(3395C)
9	BLACK HEAT SHRINK TUBE $\phi 1.0 \times 12\text{mm}$
	MOLDED PE COLOR TRANSPARENT
	MOLDED PVC PURPLE <KBD>(M2B7030)
8	BLACK PVC TUBE $\phi 3.0 \times 22\text{mm}$
	BLACK HEAT SHRINK TUBE $\phi 1.5 \times 10\text{mm}$
	BLACK HEAT SHRINK TUBE $\phi 3.0 \times 8\text{mm}$
	COPPER FOIL 33*65mm
	MOLDED PE COLOR TRANSPARENT
	MOLDED PVC BEIGE
7	MOLDED PVC BEIGE
6	UL2919 3 MINI COAXIAL CABLE 28AWG AND 4 TWISTED PAIRS 24AWG, ALUM-MYLAR FOIL AIA BRAID SHIELDING WITH DRAIN WIRE AND NON-UL 6C 28AWG, ALUM-MYLAR FOIL SHIELDING WITH DRAIN WIRE, OD 5.5*9.0*5.5mm, JACKET BEIGE, DRAWING No.EFAB2803T2404P2806C-077
5	MOLDED THUMBSCREW #4-40, LENGTH 48mm, BEIGE
4	MINI DIN 5 FEMALE, GOLD FLASH ON CONTACTS, BLACK INSULATOR
3	MINI DIN 5 MALE, GOLD FLASH ON CONTACTS, BLACK INSULATOR, SHORT TYPE
2	HD15 FEMALE, GOLD FLASH ON CONTACTS, BLUE INSULATOR
1	HD15 MALE WITHOUT PIN 9, GOLD FLASH ON CONTACTS, BLUE INSULATOR

RoHS / REACH / CE

rspro.com