

Datasheet

New 3.5mm Plug with Flange 8A 4 Way

RS Stock 874-5098



Dimensions: (mm)

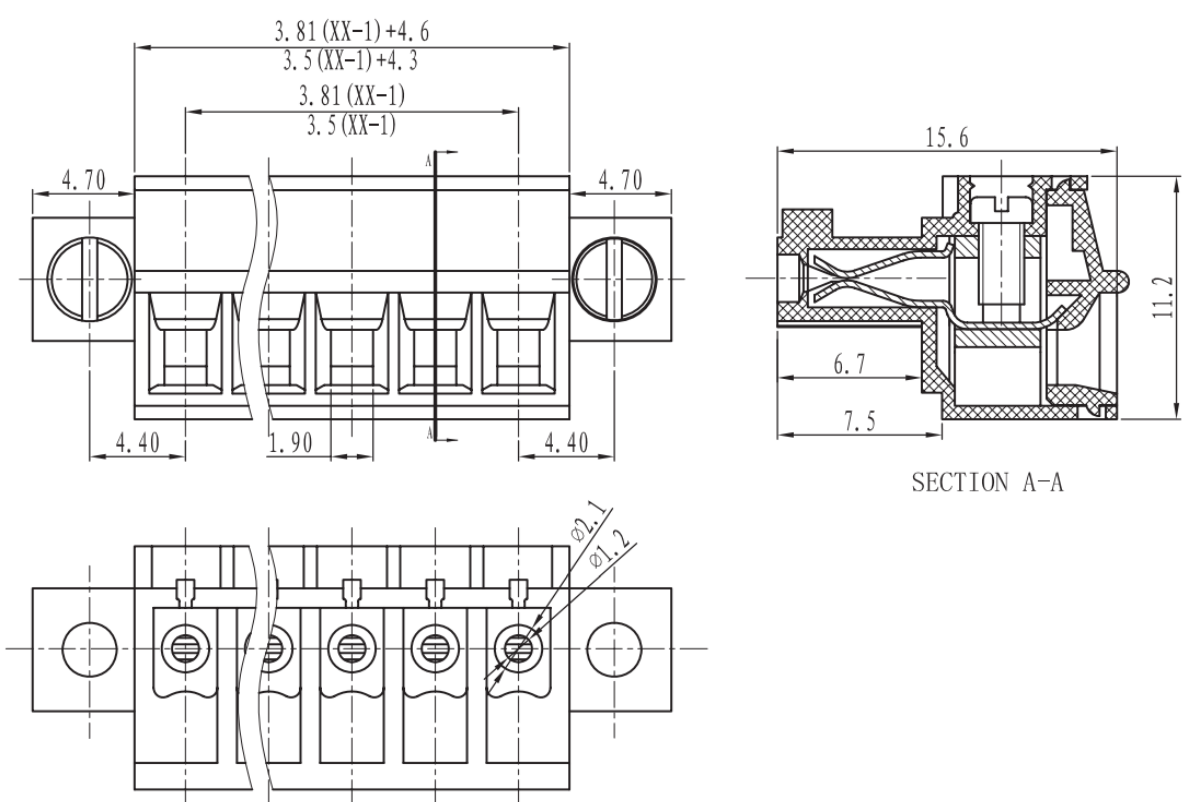



Specifications

Electrical

Standard: UL IEC
 Rated voltage: 300V 250V
 Rated current: 8A 10A
 Contact resistance: 20mΩ
 Wire range: 28-16AWG 1.5mm²
 Withstanding voltage: AC2000V/1Min
 Insulation resistance: 500MΩ/DC500V

Mechanical

Temp.Range: -40° C~+105° C
 Torque: 0.2Nm(1.71lb`in)
 Strip length: 6-7mm

Dimensions

Pitch: 3.81mm/3.5mm
 Poles: 2P-24P

Material

Housing: PA66, UL94V-0
 Screws: M2, steel Zinc plated
 Wire guard: Brass, Ni plated
 Clamp: Phosphor bronze, Ni plated

Tolerances Except As Noted

	linear dimension					fillet	chamfer		∠ short angle sid	≡	—	□	//	⊥			
	to	over	over	over	over		to	over									
variable range	to 6	over 6 to 30	over 30 to 120	over 120 to 480	over 480 to	all	to 6	to 10	to 10	to 10	to 10	to 10	to 10	to 10			
tolerance	± 0.1	± 0.2	± 0.3	± 0.5	± 0.9	± 0.2	± 0.5	± 1	1°	30'	20'	10'	0.5	0.025	0.06	0.12	0.4