

Datasheet

G57 Series 14 Way Straight PCB Socket Through Hole

RS Stock number 239-1156

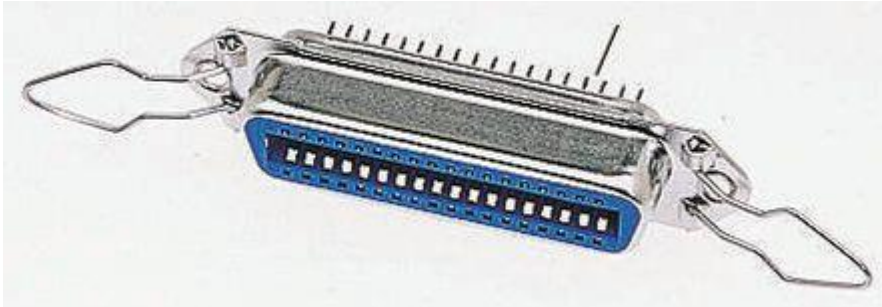

Dimensions: (mm)

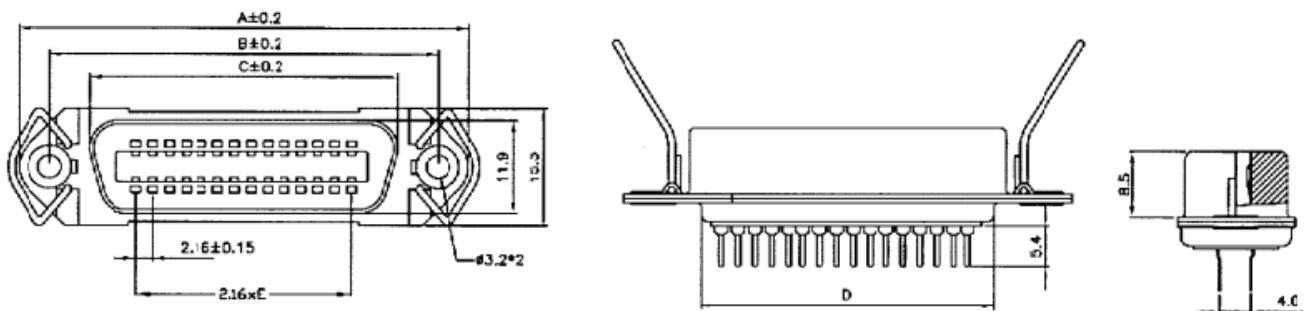

Specifications

- Shell: Steel, Nickel over copper plated
- Insulator: UL94V-0
- Contacts: Brass alloy gold plated on contact tin plated
- Current rating: 1 AMP
- Contact Resistance: < 25m ohm
- Insulation Resistance: > 1000 ohm at 500V
- Operating temperature range: -55°C to +105°C