

Datasheet

RS PRO M12 Male Rear Panel Mount 8 Pin Shielded Connector

Part No: 2017226

Technical Specifications:

Rated Operational Voltage	30 V
Current Rating	2 A
Insulation Resistance	≥100 MΩ
Temperature Range	-25° ... +75°C
Coding	A-Coded
Degree of Protection	IP67
Housing Material	Brass Ni Plated
Contact	Cu-Zn
Contact Plating	Gold Flash
Contact Carrier	Nylon 66
O-ring	Neoprene
Pole	8
Clamp Nut	M16 x 1.5

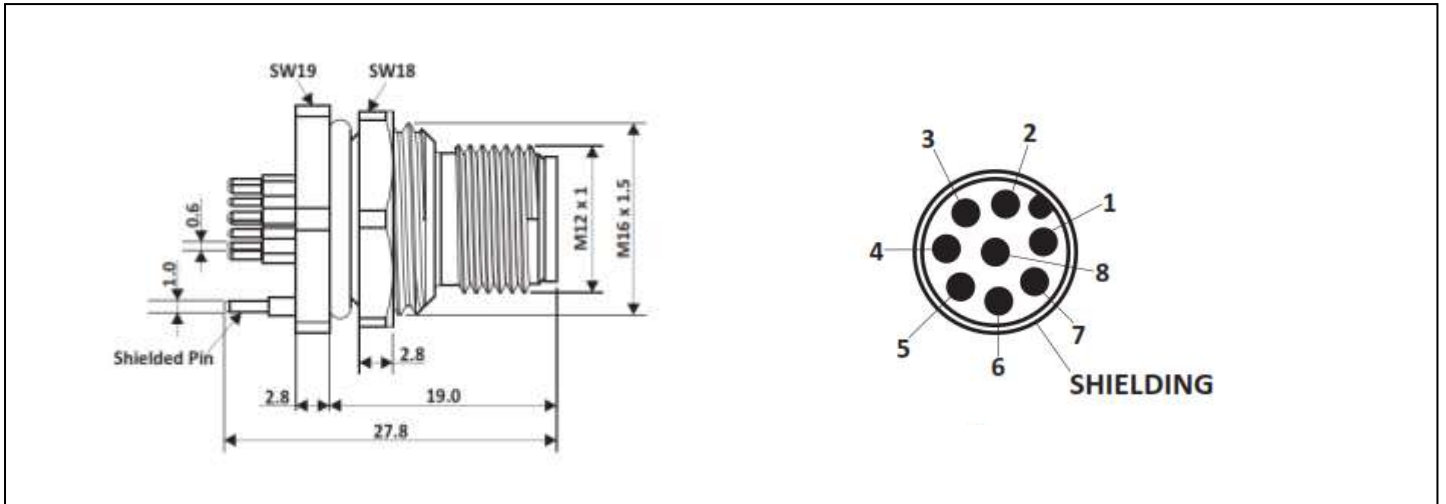

PCB Layout:

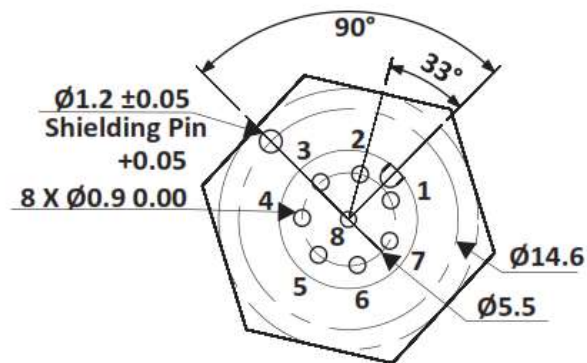

Quality Standard: IEC 61076-2-101

