



ENGLISH

Datasheet

5 way 5.08mm terminal block header

RS Stock number 790-0966



Dimensions: (mm)

PCB Layout

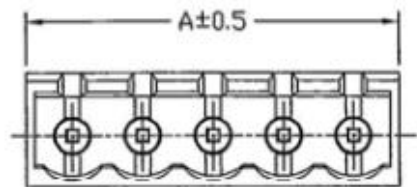
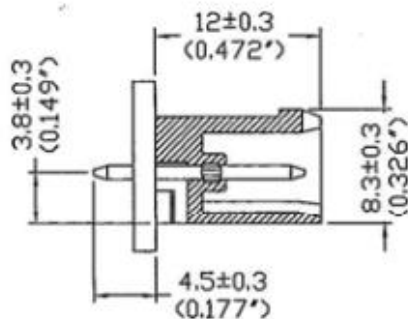
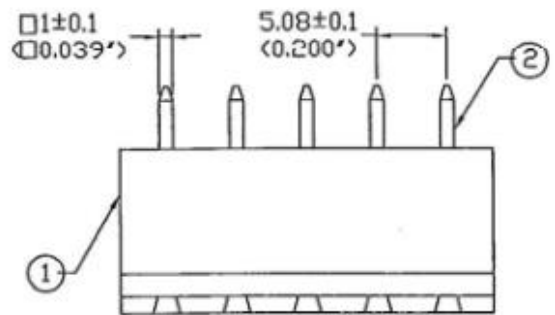
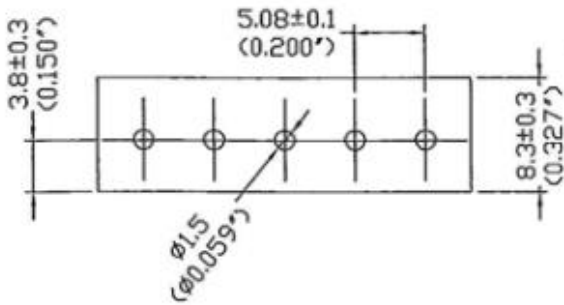



Specifications

- Current Rating:16Amp AC300V
- Insulation withstands volts: AC2000V min
- Insulation resistance: > 2000 M Ω DC500V
- Operation Temperature: -40°C to +105°C

Material

- Insulating Body: Polyamide 66 (UL94V-0)
- Solder Pin: Brass

Finish

- Solder Pin: Tin Plated
- RoHS Compliant

Pitch : 5.08mm(0.200inch)					
Poles	A(mm)	A(inch)	Poles	A(mm)	A(inch)
2	11.76	0.463	15	77.80	3.063
3	16.84	0.663	16	82.88	3.263
4	21.92	0.863	17	87.96	3.463
5	27.00	1.063	18	93.04	3.663
6	32.08	1.263	19	98.12	3.863
7	37.16	1.463	20	103.20	4.063
8	42.24	1.663	21	108.28	4.263
9	47.32	1.863	22	113.36	4.463
10	52.40	2.063	23	118.44	4.663
11	57.48	2.263	24	123.52	4.863
12	62.56	2.463	25	128.60	5.063
13	67.64	2.663			
14	72.72	2.863			