

ENCAPSULATED VARIABLE TRANSFORMERS INSTALLATION AND SAFETY INSTRUCTIONS

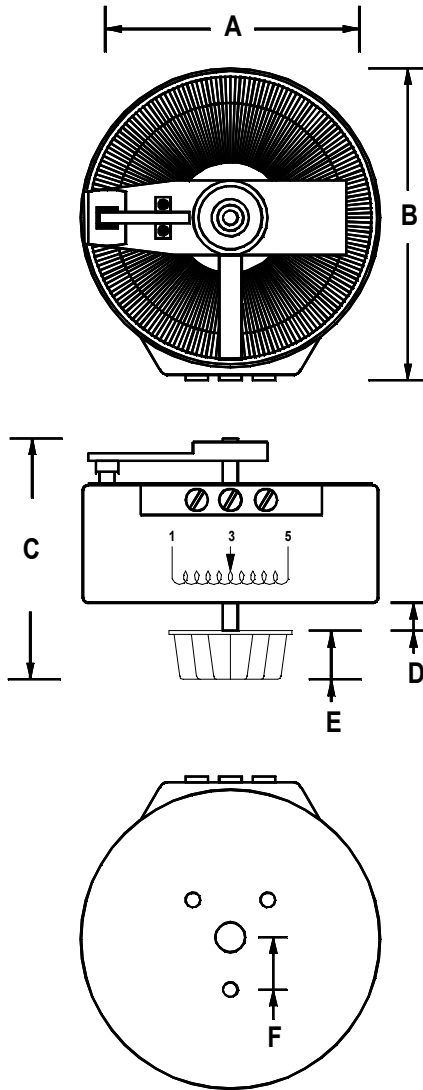

Fixing Detail

INPUT : 240V 1 Ph 50/60Hz AT 5-1
OUTPUT : 0-240V 1 Ph 50/60Hz AT 5-3

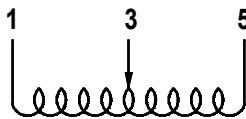

CONNECTION DIAGRAM

1. Read all of these instructions before you use the transformer.
2. This transformer is not designed to provide mains isolation.
3. Variable transformers operate at mains voltage.
DO NOT EXCEED THE MAXIMUM VOLTAGE AND CURRENT RATING.
4. Installation connection and maintenance should only be carried out by suitably qualified personnel.
5. This transformer is open style and must be fitted within its own enclosure or within a protected environment.
6. When connected to the electrical supply the terminals, brushes and track face are at mains potential with a potentially lethal voltage.
7. The output from the transformer must always be applied across the load.
Never connect the transformer in series with the load.
8. The carbon brush should be inspected for damage or wear, faulty or worn brushes will result in damage to the windings.
9. The transformer is Class 1 insulated and must not be tested on Portable Appliance Testers as Class 2 products.
Flash test only at 2kV between windings and earth.

REMOVE THE PACKING FROM THE CARBON BRUSH BEFORE PUTTING INTO SERVICE

Type	RS Part Code	Output Amps	A mm	B mm	C mm	D mm	E mm	F mm	Ø mm	Weight Kgs
WCV1X-1R	8902828	1	86	99	110	6	23	15	M4	1.6
WCV1.5X-1	8902822	1.5	113	130	127	6	30	15	M3	2.5
WCV2X-1	8902831	2	113	130	127	6	30	15	M3	4.0
WCV3X-1	8902834	3	113	130	127	6	30	15	M3	4.5
WCV4X-1	8902838	4	165	165	120	6	30	22.5	M6	5.5
WCV6X-1	8902847	6	165	165	125	8	30	22.5	M6	6.0
WCV8X-1	8902840	8	165	165	140	8	30	22.5	M6	7.5

Document Ref

RS/SI/VX

Date

Aug 2015

