

**Plug AM-TOP® - Part no. 265**

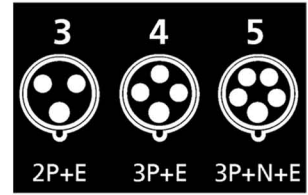

- screw terminals
- single part body
- cable gland and sealing
- strain relief and protection against kinking

Protection type IP 44  
 Ampere 32A  
 Poles 4p  
 Voltage 500V  
 Hertz 50-60Hz  
 Earth position 7h  
 Contact standard  
 Connection technology Screw terminals

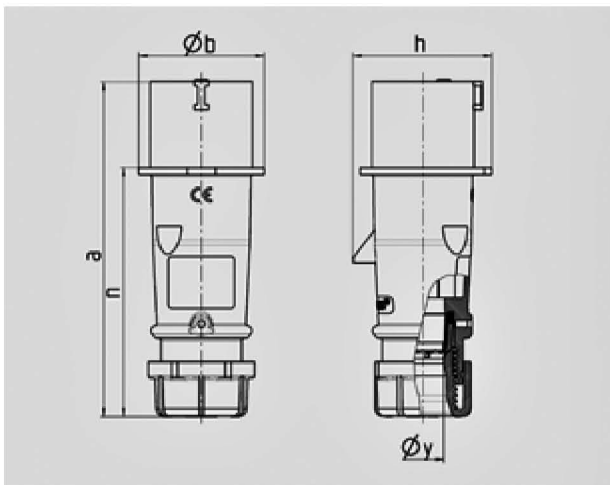

Drawing	Amp.	16			32		
		3	4	5	3	4	5
<b>2 MB 217</b>	<b>Poles</b>						
<b>Dim. in mm</b>	<b>a</b>	142	147	147	186	186	180
	<b>b</b>	53	59	67	70	70	77
	<b>h</b>	59	69,4	76	81	81	89,5
	<b>n</b>	105,2	110,5	110,5	141	141	135
	<b>y</b>	14,5	16	16	22	22	22
<b>Terminal for cond. cross</b>		1	1	1	2,5	2,5	2,5
<b>section (mm²) min.-max.</b>		-2,5	-2,5	-2,5	-6	-6	-6

